

SULLIVAN CREEK DRAIN
E09SU(102)

Repair and Improvement

Geographic Township of Sandwich South

TOWN OF TECUMSEH



Town of Tecumseh
917 Lesperance Road
Tecumseh, Ontario N8N 1W9
519-735-2184

Rood Engineering Inc.
Consulting Engineers
9 Nelson Street
Leamington, Ontario N8H 1G6
519-322-1621

REI Project 2015D010
March 1st, 2022

March 1st, 2022

Mayor and Municipal Council
Corporation of the Town of Tecumseh
917 Lesperance Road
Tecumseh, Ontario
N8N 1W9

Mayor McNamara and Members of Council:

**SULLIVAN CREEK DRAIN
E09SU(102)
Repair and Improvement
(Geographic Twp. of Sandwich South)
Project REI2015D010
Town of Tecumseh, County of Essex**

I. INTRODUCTION

In accordance with the instructions provided at your April 28th, 2015 meeting and received from the Town by letter dated May 27th, 2015, from your Director Corporate Services and Clerk, Laura Moy, we have prepared the following report that provides for repair and improvements of the open drain, along with inspection of the bridges located along the drain. The Sullivan Creek Drain comprises of an open drain generally located approximately 740 metres east of Sexton Road and 400 metres south of County Road 46. It meanders north easterly for approximately 5 km where it outlets to the Pike Creek Drain at a point approximately 760 metres north of Baseline Road and 480 metres west of County Road 19 (Manning Road) respectively, in the geographic Township of Sandwich South, Town of Tecumseh. A plan showing the Sullivan Creek Drain, as well as the general location of the bridges along the drain, is included herein as part of the report.

Our appointment and the works relative to the improvements to the Sullivan Creek Drain, proposed under this report, is in accordance with Section 78 of the "Drainage Act, R.S.O. 1990, Chapter D.17, as amended 2010". We have performed all of the necessary survey, investigations, etcetera, for the proposed bridge and drain improvements, and we report thereon as follows.

II. BACKGROUND

From our review of the information provided from the Municipality's drainage files we have established the following reports that we utilized as reference for carrying out this project:

- | | | | |
|----|--------------------|--------------------------------------|---------------------------|
| 1) | October 24th, 1977 | Sullivan Creek Drain (upper portion) | Maurice Armstrong, P.Eng. |
| 2) | May 24th, 1983 | Sullivan Creek Drain (lower portion) | Maurice Armstrong, P.Eng. |

Report - Sullivan Creek Drain
(Geographic Township of Sandwich South)
Town of Tecumseh - REI2015D010

2022-03-01

3) December 9th, 1966 Sullivan Creek Drain C.G.R. Armstrong, P.Eng.

The 1983 Report by Maurice Armstrong, P.Eng., provided for maintenance of the lower portion of Sullivan Creek Drain and has the latest profile for the grading of the drain for that section.

The 1977 Report by Maurice Armstrong, P.Eng., provided for maintenance of the upper portion of Sullivan Creek Drain and has a profile with the grading of the drain for that section.

We arranged with the Town to provide us with the updated assessment roll information for the affected parcels. We also reviewed reports for the abutting drains to help in establishing the current watershed limit for the Sullivan Creek Drain.

III. PRELIMINARY EXAMINATION AND ON-SITE MEETING

After reviewing all of the drainage information provided by the Town, we arranged with the Town Drainage Superintendent Sam Paglia, P.Eng., to schedule an on-site meeting for October 21st, 2015. The following people were in attendance at said meeting: John Wilson, Joseph and Brenda Gagnon, Leo Labbee, Joset Dworatscheu, Gerald Lavin, Richard Lafreniere, John Walton for Carl Battersby, Rosanne St. Louis, Steno Novelletto, Ken and Barb McCarthy, Joe McCarthy, Guy Robertson, Karyn Templin (County of Essex), Sam Paglia (Town Drainage Superintendent), Kory Snelgrove (Rood Engineering) and Gerard Rood (Rood Engineering).

Mr. Paglia introduced himself and reviewed some of the history of the drain. The Town had received a request for maintenance, and because of the age of the last report and the poor condition of the drain, the Town is proceeding with an engineer's report under Section 78 of the Drainage Act. The on-site meeting is the initial step in the process. The Town then asks the engineer for a draft report, and they schedule an information meeting and open house (Public Information Centre meeting) with the owners and engineer to discuss the report and plans. A final report is then prepared and submitted to Council and goes through the Drainage Act process of a Consideration meeting and Court of Revision meeting.

Mr. Rood noted that there has been some maintenance work in 1983 based on Town records, but the drain is now badly overgrown with trees and brush and appears to have a significant accumulation of sediment in some portions of the drain as per the investigations by the Town.

Mr. Rood asked the owners to provide information on any drainage changes that they might be aware of. The owners told us that there was a bridge at the O'Neil property. They were advised that the bridge will be picked up as part of the survey and inspected for its condition. The condition of the O'Neil bridge was found to be very poor, so the bridge will be replaced as part of the works.

The owners were advised that trees may be left on the top of the bank for environmental purposes. All trees within the drain cross section from top of bank to top of bank will be removed to prevent obstruction of drainage. The west side will be basically cleared for access to carry out the work and dispose of material; however, some mature trees may be able to be saved if the Contractor can work around them.

IV. FIELD SURVEY AND INVESTIGATIONS

Subsequent to the on-site meeting we arranged for a topographic survey of the drain and bridges to be completed. We further arranged to get updated assessment roll information from the

Municipality and obtained information on the tax class of each of the properties affected by the Municipal Drain. We were able to contact Jay O'Neil and discuss his bridge.

We also made initial submissions to the Essex Region Conservation Authority regarding their requirements or any D.F.O. requirements for work that would be proposed to be carried out on the access bridges within the Sullivan Creek Drain open channel. A response from the Conservation Authority was received by email on March 31st, 2015 and indicated that the proposed works cannot change the 1:100 year flood elevations. The Town must also perform a self assessment through the D.F.O. website. A copy of the concerns and requirements to satisfy E.R.C.A. and D.F.O. is included in **Appendix "REI-A"** of this report.

We also arranged to review the "Ministry of Natural Resources & Forestry (M.N.R.F.) Species at Risk (S.A.R.) Mitigation Plan for Drainage Works (March 2018-17-4938)" that the Town has prepared to address the Endangered Species Act, 2007. Section 6.0 of the Mitigation Plan indicates that snake species are a concern for this work area and although turtles are not indicated, they are mobile and could be encountered. The Mitigation Plan includes measures to be followed as outlined in "Section 7.0 Mitigation Measures" of the document and a copy of same as it relates to turtles and snakes is included in **Appendix "REI-B"**. Providing mitigation requirements are implemented, it was concluded that present wildlife Species at Risk will be protected from negative impacts and the works will not contravene Section 9 (species protection) or Section 10 (habitat protection) of the Endangered Species Act, 2007 that is administered by the Ministry of Environment, Conservation and Parks (M.E.C.P.). Based on this information we find that the Town can proceed with the eligible repairs, maintenance, and improvements to the drain as they are exempt under Sections 9 and 10 of the Act, provided that they follow the rules within Ontario Regulation 242/08 and the Mitigation Measures in their S.A.R. Mitigation Plan. To address these requirements the Town has established comprehensive mitigation measures as well as species identification guides for reference. Copies of the measures and guides shall be provided to the successful Tenderer for use during construction, and these documents are available for viewing by any interested parties at the Town office.

V. BRIDGES REVIEW

As part of our investigations, we made detailed inspections of each of the bridges along the open drain. Their condition and proposed work if any are summarized as follows:

1. This bridge serves parcel 460-01000 owned by Michael Lutsch. The 6.4m long 400mm diameter C.S.P. (corrugated steel pipe) was found to be in poor condition with the bottom beginning to rust out and will need to be replaced under maintenance in the near future.
2. This bridge serves parcel 460-01100 owned by Thomas Halford. This 27.2m long 500mm diameter C.S.P. bridge is in fair condition but has significant dirt accumulation almost halfway up the pipe and will require cleaning under this report. The report and plans will provide the Town with the details needed for future work on the bridge pursuant to the maintenance provisions of the Drainage Act.
3. This bridge serves parcel 460-01200 owned by Thomas and Linda Halford providing access to the residence. The east part of this 39.8m long 600mm diameter C.S.P. bridge serves the east portion of a shared access to the property and is in fair condition but has significant dirt accumulation in the pipe that will require cleaning under this report. The report and plans will provide the Town with the details needed for future work on the bridge pursuant to the maintenance provisions of the Drainage Act.
4. This bridge serves parcel 460-01200 owned by Thomas and Linda Halford providing access to the farm land portion. The west part of this 39.8m long 600mm diameter C.S.P. bridge serves the west portion of a shared access to the property and is in fair condition but has

- significant dirt accumulation in the pipe that will require cleaning under this report. The report and plans will provide the Town with the details needed for future work on the bridge pursuant to the maintenance provisions of the Drainage Act.
5. This bridge serves parcel 460-01300 owned by Rosemary Halford. This 6.7m long 600mm diameter C.S.P. is in fair condition but has fill accumulation to almost the mid point of the pipe that will require cleaning under this report. The report and plans will provide the Town with the details needed for future work on the bridge pursuant to the maintenance provisions of the Drainage Act.
 6. This bridge serves parcel 460-01400 owned by Thomas Halford. This 6.1m long 700mm diameter C.S.P. is in fair condition but has fill accumulation to almost the mid point of the pipe that will require cleaning under this report. The report and plans will provide the Town with the details needed for future work on the bridge pursuant to the maintenance provisions of the Drainage Act.
 7. This bridge serves parcel 460-01500 owned by Michael and Helen Lavin. This 10.4m long 700mm C.S.P. is in fair condition but has fill accumulation to almost the mid point of the pipe that will require cleaning under this report. The report and plans will provide the Town with the details needed for future work on the bridge pursuant to the maintenance provisions of the Drainage Act.
 8. This bridge serves King's Highway No. 3 and is a concrete structure with a 1.3m X 2.4m opening that is relatively new and in good condition.
 9. This bridge serves parcel 480-08410 owned by Gerald and Agnes Lavin. This 7.7m long 1200mm diameter C.S.P. is in fair condition with wood beam headwalls requiring some repairs as provided for under this report. The report and plans will provide the Town with the details needed for future work on the bridge pursuant to the maintenance provisions of the Drainage Act.
 10. This bridge serves parcel 520-01000 owned by Canada Southern Railway Company. This 13m long concrete span bridge with a 1.2m X 1.54m opening is in good condition. The report and plans will provide the Town with the details needed for future work on the bridge pursuant to the maintenance provisions of the Drainage Act.
 11. This bridge serves parcel 480-08400 owned by Gerald and Agnes Lavin. The structure is a deteriorated steel beam and wood structure with a 3m top width located just north of the former railroad bridge and this structure will be removed under this report. We recommend that the bridge be abandoned pursuant to Section 19 of the Drainage Act.
 12. This bridge serves parcel 480-08400 owned by Gerald and Agnes Lavin and is the primary access serving the parcel. This 6.1m long 1700mm diameter C.S.P. bridge is narrow by today's standards but is in fair condition. The report and plans will provide the Town with the details needed for future work on the bridge pursuant to the maintenance provisions of the Drainage Act.
 13. This bridge serves County Road 46 and comprises two (2) corrugated steel pipes of 2000mm diameter with concrete headwalls. The bridge is in fair condition. The report and plans will provide the Town and County of Essex with the details needed for future work on the bridge pursuant to the maintenance provisions of the Drainage Act.
 14. This bridge serves County Road 17. The 20.6m long 1.45m X 3.65m concrete structure appears to be in good condition. The report and plans will provide the Town and County of Essex with the details needed for future work on the bridge pursuant to the maintenance provisions of the Drainage Act.
 15. This bridge serves parcel 520-01300 owned by Kenneth & Barbara McCarthy. This 6.0m long 2100mm X 1555mm C.S.P. arch appears to be in fair condition, but the broken concrete pieces headwalls are in need of repair, and this will be provided for in this report. The report and plans will provide the Town with the details needed for future work on the bridge pursuant to the maintenance provisions of the Drainage Act.

16. This bridge serves parcel 520-04700 owned by Gerald and Agnes Lavin. Deterioration of the bridge in 2018 required emergency replacement with a “temporary” bridge. We recommend that the 14.0m long 2230mm X 1700mm C.S.P. arch “temporary” bridge become part of the drainage works pursuant to this report as it meets the design standards required. The report and plans will provide the Town with the details needed for future work on the bridge pursuant to the maintenance provisions of the Drainage Act.
17. This bridge serves King’s Highway 401. The 2.0m X 3.6m concrete bridge is in good condition. The report and plans will provide the Town and Ministry of Transportation Ontario with the details needed for future work on the bridge pursuant to the maintenance provisions of the Drainage Act.
18. This bridge serves parcel 520-04500 owned by Sandwich South Farms Ltd. The 4.25m long open bottom 1.3m X 3.7m concrete span culvert appears to be in good condition. Some washouts of the drain banks at the corners of the bridge will be repaired under this report with quarried limestone on filter cloth. The report and plans will provide the Town with the details needed for future work on the bridge pursuant to the maintenance provisions of the Drainage Act.
19. This bridge serves the County Road 43. The 1.58m X 4.6m concrete box bridge was recently replaced and is in good condition. The report and plans will provide the Town and County of Essex with the details needed for future work on the bridge pursuant to the maintenance provisions of the Drainage Act.
20. This bridge serves as an access for parcel 510-01550 owned by Rose Jobin. The 4.8m top width 1.9m X 3.8m concrete span bridge appears to be in fair condition. The report and plans will provide the Town with the details needed for future work on the bridge pursuant to the maintenance provisions of the Drainage Act.
21. This pipe arch bridge serves parcel 510-01800 owned by Wilfred O’Neil. The bridge was collapsing and replaced with a new “temporary” bridge in 2015 including precast concrete block headwalls. We recommend that the 11.0m long 3.3m X 2.08m C.S.P. arch “temporary” bridge become part of the drainage works pursuant to this report as it meets the design standards required. The report and plans will provide the Town with the details needed for future work on the bridge pursuant to the maintenance provisions of the Drainage Act.
22. This concrete span bridge serves parcel 510-02000 owned by Ruth Battersby. The 4.5m long 1.9m X 4.3m concrete bridge appears to be in reasonable condition. The report and plans will provide the Town with the details needed for future work on the bridge pursuant to the maintenance provisions of the Drainage Act.
23. This is a 2.5m X 5.2m concrete bridge that is 10.5m long and that was newly installed in 2015 for the Town Baseline Road. The bridge is in excellent condition. The report and plans will provide the Town with the details needed for future work on the bridge pursuant to the maintenance provisions of the Drainage Act.
24. This 6.2m long 2900mm X 2080mm C.S.P. arch bridge with broken concrete pieces headwalls serves parcel 560-08100 owned by 507822 Ontario Inc. & 494112 Ontario Ltd. The bridge is in fair condition. The report and plans will provide the Town with the details needed for future work on the bridge pursuant to the maintenance provisions of the Drainage Act.
25. This 13.85m long concrete bridge serves the 12th Concession Road of the Town. The 2.55m X 4.25m bridge is in good condition with some scouring of the footing noted at the northeast headwall that will be addressed under this report. The report and plans will provide the Town with the details needed for future work on the bridge pursuant to the maintenance provisions of the Drainage Act.

We prepared preliminary designs and estimates for improvement of those bridges in the future and for those that require work at this time. We contacted some of the bridge owners to discuss their bridge replacement or repairs with them and to determine if there were any concerns that the owner was aware of that should be addressed as part of the report. Preliminary details of the proposed work and cost estimates for work on the bridge were discussed with Mr. O'Neil, along with cost sharing. The owner was reminded that they would also share in the cost of the work along the downstream portions of the drain. Mr. O'Neil indicated that the pipe at the rear of their property was in poor condition and needs replacement and requested a new access across the Sullivan Creek Drain.

VI. PUBLIC INFORMATION CENTRE REVIEW

Arrangements were made for a virtual meeting on August 19th, 2021, with the Engineer, the Drainage Superintendent and interested owners to discuss the Draft drainage report dated June 16th, 2021, for this project. The procedures under the Drainage Act were reviewed and the next steps were detailed. There will be Town, County of Essex, and Ministry of Transportation contributions to cost for this project because the project is a Municipal drain and public roads, or lands are affected. The owners were advised that snow blockage can occur, but the Drainage Act does not require this to be addressed. The Town did however do some removal in the past to alleviate flooding problems that arose and is expected to address this again in the future if the need arises. Owners are advised that there is the opportunity to debenture the costs for 5 years and pay the assessment with their taxes. Owners are advised that they only pay a share of the cost for work adjacent to their lands and for downstream to the outlet. Once the Town is aware of concerns, they are obliged to act in accordance with the requirements of the Drainage Act.

Benefit and Outlet liability assessments are discussed as defined below. Establishment of pipe lengths is based on the minimum standard top width of 6.1m (20'), the depth of the drain, and the type of end treatment provided. The cost of additional top width requested by an owner is fully borne by that owner. The drainage report provides estimates of costs, and the owners will only pay the actual cost shared on the basis of the assessment schedule. Lands eligible for the farm property tax class will be eligible for a grant in the amount of 1/3 of their total cost assessment.

If the work is not started before March 15th, it will likely be completed in the summer or fall. If any delay occurs, the fish protection timing window from March 15 to June 30th will come into effect and the work will have to be done after June 30th. Bridge cost sharing was reviewed with the owners at the P.I.C. meeting. Existing pipes are normally cleaned by flushing them with a high pressure nozzle and the material is removed at the end of the pipe. The owners are advised that they can have their tile ends repaired by a qualified contractor. The tiles are inspected during the course of the work and only those in disrepair will be fixed up as part of the work.

It should be noted that the Public Information Centre (P.I.C.) meeting is not a requirement under the Drainage Act but the Town holds these meetings to address questions and concerns and to solicit comments from the affected owners. Feedback during and after the meeting was utilized to establish the final requirements for the drainage report.

Owners are reminded that they have the opportunity to present their concerns to Council regarding the report details at the Consideration meeting and assessment questions at the Court of Revision meeting, along with appeal rights to the Ontario Ministry of Agriculture, Food and Rural Affairs (O.M.A.F.R.A.) Appeals Tribunal and to the Drainage Referee as provided for in the Drainage Act.

Clarification is provided on the two (2) types of assessments included within the report. The Drainage Act definitions and applicable clauses are as follows:

“Benefit” means the advantages to any lands, roads, buildings or other structures from the construction, improvement, repair, or maintenance of a drainage works such as will result in a higher market value or increased crop production or improved appearance or better control of surface or subsurface water, or any other advantages relating to the betterment of lands, roads, buildings or other structures.

“Outlet liability” means the part of the cost of the construction, improvement or maintenance of a drainage works that is required to provide such outlet or improved outlet. Lands and roads that use a drainage works as an outlet, or for which, when the drainage works is constructed or improved, an improved outlet is provided either directly or indirectly through the medium of any other drainage works or of a swale, ravine, creek, or watercourse, may be assessed for outlet liability. The assessment for outlet liability shall be based upon the volume and rate of flow of the water artificially caused to flow upon the injured land or road or into the drainage works from the lands and roads liable for such assessments. Every drainage works constructed under this Act shall be continued to a sufficient outlet.

Owners are advised that they have a legal responsibility to convey their drainage to a sufficient outlet. For this reason, they have a share in the cost for upkeep of the drain downstream of their lands and this obligation is reflected in the assessment for Outlet. There were concerns raised that some owners maintain the drain banks along their properties, and they should therefore not be assessed or assessed less. They are reminded that the responsibility for carrying out maintenance on a Municipal drain rests with the Town as set out in the Drainage Act. Any owner can notify the Town that the drain requires maintenance, and the Town has to take action pursuant to the Act. This system is generally reactive and requires the property owners to raise their concerns and issues to the Town. Owners are reminded that keeping brush clear along their portion of the drain and having buffer strips provides them with a direct benefit of improved crop yield and preservation of topsoil on their lands. It was suggested that they were being penalized for the work that they had done, but it was pointed out that sediment in their portion of the drain has to be removed and they still have an Outlet Liability for the downstream portion of the drain. The owners are reminded that Municipal drainage is a communal project and basically a user pay system. As an example, when work is carried out on the Pike Creek Drain downstream of the Sullivan Creek Drain outlet, the owners in the Sullivan watershed would be responsible for a portion of the cost, along with the other owners in the Pike Creek Drain watershed. Owners are advised of the 1/3 grant available to agricultural lands that qualify, and that the Town administers the grant process and reflects any available grant on the final billing to each owner.

It was indicated that some owners may appeal their assessment as set out in the drainage report. They are advised that they should submit their appeal to the Court of Revision 10 days before the scheduled date of the meeting; however, the Court of Revision can agree to hear appeals presented at the meeting. If owners are still dissatisfied with the report after that meeting, they may submit an appeal to the O.M.A.F.R.A. Appeals Tribunal through the Town Clerk within 21 days of the closing of the Court of Revision pursuant to Section 54 of the Drainage Act.

The cost sharing for bridges was discussed with some owners feeling that the bridge owner should bear all the cost. It was explained that an owner has the right for one access across each Municipal drain. The owner generally pays 100% of the cost for the first bridge installation and it becomes part of the drain when included in an engineer’s report and is then to be maintained by the drain. The Engineer explained that he determines the cost sharing, and it generally relates to a bridge, that is part of the drain, and located at the mid length of the drain, being shared 50%-

50%. The ratio to the bridge owner diminishes as you proceed downstream or increases as you proceed upstream from that point.

The time required to initiate the project was discussed. It was pointed out that the Town has 45 days under Section 79 of the Act to take action or could be liable for damages. An owner would have to quantify any damages experienced and could try to sue the Town. The Act does provide for the owners to make appeals if the Town fails to take action on certain matters prescribed in the legislation.

There was some discussion of the disposal of excavated materials on the abutting lands. The Engineer confirmed that existing grass buffers and accesses would be protected and maintained. Allowances as set out in the report were reviewed and access provisions that are set out in the report Specifications was referenced. Owners were advised that the Contractor is responsible to remove any sticks and rocks (cobble) etcetera from the spread materials and the Contractor is responsible for one (1) year after the work is completed.

There were questions about assessment for cost when an owner's property does not drain to the Municipal drain. We explained that lands may be assessed for a "cutoff" benefit in the case where the construction of a drain prevents overland flows from going across their lands. Being relieved of these flows results in less damage to their lands and crops and is therefore considered as a benefit and an assessment is provided for same. It was pointed out that the lands that do not drain into the Municipal drain are only assessed Benefit, and there is no assessment for Outlet if they do not direct any flows into the drain. Further questions included assessment for lands that are completely tiled to the drain, the limits of the watershed relative to the Little 10th Concession Drain at the northwest corner of the watershed, and adjustments for area and runoff for the Lutsch lands at the upstream end of the drain.

There was a question about removal of dead and overhanging trees on the top of the banks. We advised the owner that the specifications would provide more detail directing the Contractor to include for this work as part of the brushing on the drain so that the risk of said materials falling in and blocking off or damaging the drain is minimized.

Owners have the right to ask Council questions at the Consideration meeting and Court of Revision meeting.

VII. FINDINGS AND RECOMMENDATIONS

We find that the profiles included in the 1983 and 1987 report plans by Maurice Armstrong, P.Eng. provide a good fit to the existing profile of the drain. Said reports provided for improvements to the open drain and we have used the grades and other drain parameters to establish the design and work included for in this report.

Based on our detailed survey, investigations, examinations, and discussions with the affected Owners and governing Authorities, we would recommend that drain improvement works be carried out as follows:

- a) Bridge 11 be completely removed from the drain and the drain cross section be restored in accordance with the information on the profiles and cross sections. We recommend that the bridge be abandoned pursuant to Section 19 of the Drainage Act.
- b) We recommend that all drain improvements, including the removal of the farm bridge and bridge repairs and improvements, be carried out in accordance with the

requirements established by E.R.C.A. and D.F.O. as set out in the documents within **Appendix "REI-A"** attached to this report.

- c) As this is an existing Municipal drain, and conditions have not changed and there is no information to indicate any new species concerns, the construction can be carried out based on the provisions included within the Mitigation Plan for Drainage Works (March 2018-17-4938) that the Town has prepared to address the Endangered Species Act, 2007 now administered by the Ministry of Environment, Conservation and Parks (M.E.C.P.). Providing mitigation requirements are implemented, we find that present wildlife Species at Risk will be protected from negative impacts and the works will not contravene Section 9 (species protection) or Section 10 (habitat protection) of the Endangered Species Act, 2007. Based on this information we find that the Town can proceed with the eligible repairs, maintenance, and improvements to the drain as they are exempt under Sections 9 and 10 of the Act, provided that they follow the rules within Ontario Regulation 242/08 and the Mitigation Measures in their S.A.R. Mitigation Plan. A copy of said mitigation measures is included in **Appendix "REI-B"** within this report. We recommend that any work being completed shall be carried out in accordance with Town mitigation measures as included in **Appendix "REI-B"** for reference by the land owners, the Town of Tecumseh, and the Contractor who will be conducting the works.
- d) We find that portions of the open drain have significant accumulation of silt and debris and we recommend that these be cleaned out as set out further in this report.
- e) The existing drain has some buffer strips and grass accesses along the Municipal drain that reduce the amount of erosion and the sediment entering the drain and enhance water quality. We recommend that the existing buffer strips be protected as part of this project and suggest that new buffer strips be constructed by the owners in all areas where no current grass buffer exists.
- f) As provided for by Section 18 of the Drainage Act, we recommend that any future new access bridge culvert or replacement be constructed as outlined further in this report including the specifications and the plans that form part of the report. All existing bridges and access pipes that are in fair or good condition shall be flushed and cleaned out to restore the drain bottom profile.
- g) Near the drain outlet northeasterly of 12th Concession Road any excavated materials shall be hauled away as required by E.R.C.A. This area will generally extend from the east side of 12th Concession Road to the outlet in Pike Creek Drain.

We further find and recommend as follows:

- h) **Bridge No. 1** – Michael Lutsch (460-01000)

This corrugated steel pipe access is badly rusted with poor bottom on the east end. We recommend that the existing 400mm diameter pipe be replaced as set out further in this report under maintenance when the need arises.

- i) **Bridge No. 2** – Thomas Halford (460-01100)

The east broken concrete pieces endwall has been repaired subsequent to our field survey. We recommend that the materials be salvaged, and the headwall be

reconstructed utilizing grout and additional pieces, or concrete filled jute bags as needed to create a stable headwall when the pipe is replaced in the future.

j) **Bridge No. 9** – Gerald & Agnes Lavin (480-08410)

The wooden beam headwalls on this bridge are in very poor condition and in need of repair. We recommend that new pressure treated timber be provided to replace unsuitable materials and restore the headwalls to a stable condition including any tie-backs needed.

k) **Bridge No. 11** – Gerald & Agnes Lavin (480-08400)

This bridge is unsuitable for rehabilitation, and we recommend that the existing rotted timber top, rusted steel beams, and concrete abutments be removed and disposed of and that the drain be restored to its design cross section as shown on the profile and cross sections of the plans. As noted above, the bridge is recommended to be abandoned pursuant to Section 19 of the Drainage Act.

l) **Bridge No. 15** – Kenneth & Barbara McCarthy (520-01300)

The broken concrete pieces endwalls are collapsed and in need of repair. We recommend that the materials be salvaged, and the headwalls be reconstructed utilizing grout and additional pieces, or concrete filled jute bags as needed to create stable headwalls.

m) **Bridge No. 16** – Gerald & Agnes Lavin (520-04700)

This bridge was collapsing at the time of the drain survey. A “temporary” new replacement bridge was installed in accordance with the plans and report dated May 3rd, 2018, that were used to obtain the permit from E.R.C.A. We recommend that the “temporary” bridge that was installed pursuant to the E.R.C.A. permit become a part of the Sullivan Creek Drain under this report and be kept up and maintained by the Town as part of the drainage works in accordance with the details and specifications provided in this report.

n) **Bridge No. 18** – Sandwich South Farms Ltd. (520-04500)

This concrete span bridge is in good condition but some washouts of the drain banks at the corners of the bridge were observed. We recommend that the drain banks be restored with compacted clay fill and that quarried limestone rip rap on filter cloth be installed on the banks adjacent to the bridge corners to protect the newly placed fill and minimize the risk of future erosion.

o) **Bridge No. 21** – Wilfred O’Neil (510-01700 & 510-01800)

The existing bridge near the north limit of Parcel 510-01700 was collapsing and replaced with a new “temporary” bridge just north of the existing bridge and constructed on Parcel 510-01800. The new replacement bridge was installed in accordance with the plans and report dated November 3rd, 2015, utilized for the permit application to the E.R.C.A. for the pipe arch including precast concrete block headwalls. HEC-RAS modeling was carried out to compare existing to final conditions with the new bridge installation. The modeling results were submitted to E.R.C.A. on January 5th, 2016 and showed that no significant impact occurred to the drainage works. We recommend that the “temporary” bridge

become part of the drainage works pursuant to this report as it meets the design standards required. The report and plans will provide the Town with the details needed for future work on the bridge pursuant to the maintenance provisions of the Drainage Act. The bridge will provide both parcels with access across the drain.

p) **Bridge No. 25** – 12th Concession Road – Town of Tecumseh

This concrete bridge appears to be in good condition with some scouring noted around the footing on the east end of the bridge. We recommend that the drain be restored with compacted clay fill and that quarried limestone rip rap on filter cloth be installed on the newly placed fill to minimize the risk of future erosion.

We have investigated the watershed boundaries as per the Public Information Centre meeting and made adjustments to the drainage report to reflect the updated findings and the input from affected owners that was provided. This drainage report provides for the Sullivan Creek Drain to be restored to its past design standards to restore its original level of service with none of the works that are provided for with having any negative or adverse impacts to the drain or level of service. Information that was provided to E.R.C.A. for the “temporary” bridges that needed to be constructed under emergency requirements demonstrated that no significant impact was caused to the drainage works by the new bridges being installed. We recommend that the Sullivan Creek Drain be repaired and improved, including the bridge removal as outlined, in accordance with this report, the attached specifications and the accompanying drawings, and that all works associated with same be carried out pursuant to Section 78 of the “Drainage Act, R.S.O. 1990, Chapter D.17 as amended 2010”.

VIII. ALLOWANCES

We have provided that all of the work will generally be completed from the north and west side of the drain. Between Bridge 19 and Bridge 20 the drain cleaning will be carried out from the east side of the drain with the materials spread to the east. From Highway No. 3 to County Road 46 the work will be carried out from the east side of the drain to protect mature trees and plantings conducted with E.R.C.A. support. The Contractor will be required to restore any existing grassed buffer and driveway areas damaged by the work. We recommend that any materials removed from the open drain or existing bridges, be spread on the adjacent open agricultural lands to the north, east, and west of the drain for disposal by the Contractor, beyond the limits of any existing grass buffer or driveway access. Based on all of the above we find that allowances for damages are payable pursuant to Sections 29 and 30 of the Drainage Act.

We find that the provision of access along the drain as noted above and disposal of excavated material on the abutting agricultural lands requires payment for the land necessary to carry out same. Where there are lawn areas along the drain, work may be carried out from the road side of the drain and the excavated material will be loaded up and hauled away for disposal and any damage to the lawn will need to be restored by the Contractor, so no allowance is required for those areas. We therefore recommend that the following owners be compensated where values are shown for all work areas that will be impacted, including for the access to the drain and for damages to lands and crops, if any, as follows, namely:

1)	Michael Lutsch, (460-01000),	Owner,	Part of Lot 297, S.T.R. Concession,	\$	450.00
----	---------------------------------	--------	--	----	--------

Report - Sullivan Creek Drain
(Geographic Township of Sandwich South)
Town of Tecumseh - REI2015D010

2022-03-01

2)	Thomas Halford, (460-01100),	Owner,	Part of Lot 298, S.T.R. Concession,	\$	lawn
3)	Thomas & Linda Halford, (460-01200),	Owners,	Part of Lot 298, S.T.R. Concession,	\$	401.00
4)	Rosemary Halford, (460-01300),	Owner,	Part of Lot 298, S.T.R. Concession,	\$	lawn
5)	Thomas Halford, (460-01400),	Owner,	Part of Lot 298, S.T.R. Concession,	\$	433.00
6)	Michael & Helen Lavin, (460-01500),	Owners,	Part of Lot 298, S.T.R. Concession,	\$	665.00
7)	John Lafferty, (460-09200),	Owner,	Part of Lot 299, S.T.R. Concession,	\$	1,621.00
14)	Catherine Lafferty & Mary Thompson, (460-02000),	Owners,	Part of Lot 299, S.T.R. Concession,	\$	1,577.00
23)	Gerald & Agnes Lavin, (480-08410),	Owners,	Part of Lot 298, N.T.R. Concession,	\$	2,794.00
22)	Gerald & Agnes Lavin, (480-08400),	Owners,	Part of Lot 298, N.T.R. Concession,	\$	1,349.00
80)	Diklich Capital Corp., (530-00100),	Owner,	Part of Lot 10, Concession 9,	\$	1,288.00
82)	Edward Chittle Jr., (530-04775),	Owner,	Part of Lot 11, Concession 9,	\$	lawn
58)	Kenneth & Barbara McCarthy, (520-01300),	Owners,	Part of Lots 11 & 12, Concession 10,	\$	3,089.00
76)	Gerald & Agnes Lavin, (520-04700),	Owners,	Part of Lot 12, Concession 10,	\$	964.00
73)	Sandwich South Farms Limited, (520-04500),	Owner,	Part of Lot 13, Concession 10,	\$	1,253.00
41)	Rose Jobin, (510-01550),	Owner,	Part of Lots 13 & 14, Concession 11,	\$	840.00
43)	Paul & Rose Jobin, (510-01600),	Owners,	Part Lot 14, Concession 11,	\$	554.00
45)	Wilfred O'Neil, (510-01700),	Owner,	Part Lot 14, Concession 11,	\$	639.00

Report - Sullivan Creek Drain
(Geographic Township of Sandwich South)
Town of Tecumseh - REI2015D010

2022-03-01

46)	Wilfred O'Neil, (510-01800),	Owner,	Part Lot 15, Concession 11,	\$	441.00
47)	Wilfred O'Neil, (510-01900),	Owner,	Part Lot 15, Concession 11,	\$	521.00
48)	Ruth Battersby, (510-02000),	Owner,	Part Lot 15, Concession 11,	\$	2,541.00
51)	Helene Battersby, (510-02100),	Owner,	Part Lot 16, Concession 11,	\$	3,877.00
91)	Philip, Rose & Paul Jobin, (560-04000),	Owners,	Part Lot 17, Concession 11,	\$	2,885.00
94)	507822 Ontario Inc. & 494112 Ontario Limited, (560-08100),	Owners,	Part Lot 17, Concession 11,	\$	2,389.00
93)	Mary McGraw, (560-08000),	Owner,	Part Lot 18, Concession 11,	\$	677.00
79)	Mario & Deana Liburdi, (560-08500),	Owners,	Part of Lot 18, Concession 12,	\$	1,113.00
TOTAL FOR ALLOWANCES AND DAMAGES				\$	32,361.00

These values for allowances and damages are based on a strip of land parallel to and immediately adjacent to the drain or grassed buffer and driveway, for the parcels generally abutting the north and west side of the Municipal drain and south side from Bridge 19 to Bridge 20 and are based on a value of \$1,225.00 per acre (\$3,027.00 per hectare) for the affected lands and crops, if any. These allowances provide for a spread depth of 100mm and are calculated using a rate per acre of \$700.00 for year one, \$350.00 for year two and \$175.00 for the third year. The impact after 3 years is considered negligible.

We have provided for this in our estimate as is provided for under Sections 29 and 30 of the "Drainage Act, R.S.O. 1990, Chapter D.17, as amended 2010".

IX. ESTIMATE OF COST

Our estimate of the Total Cost of this work, including all incidental expenses, is the sum of **SIX HUNDRED AND THIRTY ONE THOUSAND EIGHT HUNDRED DOLLARS (\$631,800.00)**, made up as follows:

Report - Sullivan Creek Drain
(Geographic Township of Sandwich South)
Town of Tecumseh - REI2015D010

2022-03-01

CONSTRUCTION

Item 1)	<u>Station 0+000 to Station 9+963</u> ; Carry out excavation of the drain to remove accumulated sediment and restore the drain to the profile grade shown on the plans, including all loading, hauling, and disposal where required, and leveling of material, approximately <u>9,963</u> lineal metres (approximately 9,360 cubic metres).	Lump Sum	\$	190,000.00
Item 2)	<u>Bridge No. 2</u> ; Provide all material, equipment and labour to salvage the existing broken concrete endwall pieces and reconstruct the headwalls utilizing concrete grout and additional pieces or concrete filled jute bags as needed to create stable headwalls, complete. (Thomas Halford)	Lump Sum	\$	2,500.00
Item 3)	<u>Bridge No. 9</u> ; Provide all material, equipment and labour to repair the existing timber headwalls with pressure treated lumber, anchors, and tiebacks as needed to create stable headwalls, complete. (Gerald & Agnes Lavin)	Lump Sum	\$	2,500.00
Item 4)	<u>Bridge No. 11</u> ; Provide all material, equipment and labour to remove and dispose of the existing steel beam and timber structure and concrete abutments and restore the drain to its design cross section, including all loading, hauling, disposal, topsoil placement, seed, and mulch, complete. (Gerald & Agnes Lavin)	Lump Sum	\$	1,500.00
Item 5)	<u>Bridge No. 15</u> ; Provide all material, equipment and labour to salvage the existing broken concrete endwall pieces and reconstruct the headwalls utilizing concrete grout and additional pieces or concrete filled jute bags as needed to create stable headwalls, complete. (Kenneth & Barbara McCarthy)	Lump Sum	\$	2,500.00
Item 6)	<u>Bridge No. 16</u> ; Provide all material, equipment and labour to excavate the drain, completely remove and dispose of the existing pipe and any endwall materials, including any other deleterious material encountered; supply and install 14.0 metres of 2230mm X 1700mm, 2.8mm thick aluminized corrugated steel pipe arch with 125X26mm corrugations including Granular 'B' backfill, Granular 'A' travel surface; excavation, placement, compaction, grading; 305mm thick quarried limestone on filter cloth sloped end protection; topsoil placement, seeding and mulching, and restoration and clean up, complete. (Gerald & Agnes Lavin)	Lump Sum	\$	20,155.00
Item 7)	<u>Bridge No. 18</u> ; Provide all material, equipment and labour to repair the drain banks adjacent to the bridge corners including placement of clay fill, compaction, and			

Report - Sullivan Creek Drain
 (Geographic Township of Sandwich South)
 Town of Tecumseh - REI2015D010

2022-03-01

	installation of approximately 20 tonnes of quarried limestone rip rap on filter cloth to protect the banks from erosion, complete. (Sandwich South Farms Ltd.)	Lump Sum	\$	1,200.00
Item 8)	Bridge No. 21; Provide all material, equipment and labour to excavate the drain, completely remove and dispose of the existing pipe and any endwall materials, including any other deleterious material encountered; supply and install 11.0 metres of 3300mm X 2080mm, 3.5mm thick aluminized corrugated steel pipe arch with 125X26mm corrugations including Granular 'B' backfill, Granular 'A' travel surface; excavation, placement, compaction, grading; precast concrete block headwalls; topsoil placement, seeding and mulching, and restoration and clean up, complete. (Wilfred O'Neil)	Lump Sum	\$	29,400.00
Item 9)	Bridge No. 25; Provide all material, equipment and labour to repair the drain bank adjacent to the northeast bridge footing at the east side including placement of clay fill, compaction, and installation of approximately 10 tonnes of quarried limestone rip rap on filter cloth to protect the bank from erosion at the footing, complete. (Town of Tecumseh)	Lump Sum	\$	600.00
Item 10)	Station 0+000 to Station 9+963; Supply and install new heavy duty H.D.P.E. plastic tile main extensions, including connections, rodent grate, removal of any deleterious materials, excavation, backfill, compaction and restoration, complete:			
	a) 3.0 metres (10') of 150mm (6") diameter pipe for 150mm diameter tiles: <u>7</u> required at <u>\$200.00</u> each		\$	1,400.00
	b) 3.0 metres (10') of 200mm (8") diameter pipe for 200mm diameter tiles: <u>19</u> required at <u>\$250.00</u> each		\$	4,750.00
	c) 3.0 metres (10') of 250mm (10") diameter pipe for 250mm diameter tiles: <u>9</u> required at <u>\$300.00</u> each		\$	1,200.00
	d) 3.0 metres (10') of 300mm (12") diameter pipe for 300mm diameter tiles: <u>7</u> required at <u>\$500.00</u> each		\$	3,500.00
Item 11)	Station 0+000 to Station 9+963; Supply and install approximately <u>222</u> lateral tile drain extensions to outlet end of damaged existing 100mm diameter lateral tiles entering the drain, including excavation, rodent grate, backfill, compaction, topsoil placement and seed and mulch, complete at <u>\$50.00</u> each.		\$	11,100.00
Item 12)	Station 0+000 to Station 9+963; Supply and install approximately <u>360</u> tonnes of quarried limestone rip rap for rock chute spillways and general erosion protection, complete at <u>\$65.00</u> per tonne.		\$	23,400.00

Report - Sullivan Creek Drain
(Geographic Township of Sandwich South)
Town of Tecumseh - REI2015D010

2022-03-01

Item 13)	Station 0+000 to Station 9+963; Supply and install approximately <u>720</u> square metres of synthetic filter mat for rock chute spillways and general erosion protection, complete at <u>\$5.00</u> per square metre.	\$	3,600.00
Item 14)	Brushing and grubbing including all disposal and clean up (approximately 9,963 lineal metres), removing and reinstalling fences, complete. Lump Sum	\$	99,650.00
Item 15)	Spread scavenged topsoil; carry out seeding and mulching on all newly excavated side slopes (approximately 9,963 lineal metres), including all harrowing, raking, preparation and clean up, complete. Lump Sum	\$	60,000.00
Item 16)	Estimated net Harmonized Sales Tax (1.76% H.S.T.) on construction items above. Lump Sum	\$	8,178.00
TOTAL FOR CONSTRUCTION			\$ 467,133.00

INCIDENTALS

1)	Report, Estimate, & Specifications	\$	19,900.00
2)	Survey, Assistants, Expenses, and Drawings	\$	85,750.00
3)	Duplication Cost of Report and Drawings	\$	2,000.00
4)	Estimated Cost of Letting Contract	\$	1,500.00
5)	Estimated Cost of Layout and Staking	\$	2,000.00
6)	Estimated Cost of Part-Time Supervision and Inspection During Construction (based on 2 week duration)	\$	6,000.00
7)	Estimated Net H.S.T. on Incidental Items Above (1.76%)	\$	2,057.00
8)	Estimated Cost of Interim Financing	\$	1,500.00
9)	Estimated Cost of E.R.C.A. Permit	\$	1,500.00
9)	Contingency Allowance	\$	10,099.00
TOTAL FOR INCIDENTALS			\$ 132,306.00

Report - Sullivan Creek Drain
(Geographic Township of Sandwich South)
Town of Tecumseh - REI2015D010

2022-03-01

TOTAL FOR ALLOWANCES (brought forward)	\$	32,361.00
TOTAL FOR CONSTRUCTION (brought forward)	\$	467,133.00
TOTAL ESTIMATE	\$	631,800.00

X. DRAWINGS AND SPECIFICATIONS

As part of this report, we have attached design drawings for the construction of the drain improvements and farm bridge improvements. The design drawings show the subject bridges and improvement locations and the details of the work, as well as the approximate location within the watershed area. The design drawings are attached to the back of this report and are labelled **Appendix "REI-E"**.

Also attached, we have prepared Specifications which set out the required construction details for the bridge improvements and drain repair and improvements, which also include Standard Specifications labelled therein as **Appendix "REI-C"**.

XI. SCHEDULE OF ASSESSMENT

We would recommend that the Total Cost for construction of this project, including incidental costs, be charged against the lands affected in accordance with the attached Construction Schedule of Assessment. On September 22nd, 2005, the Ontario Ministry of Agriculture, Food and Rural Affairs (O.M.A.F.R.A.) issued Administrative Policies for the Agricultural Drainage Infrastructure Program (A.D.I.P.). This program has re-instated financial assistance for eligible costs and assessed lands pursuant to the Drainage Act. Sections 85 to 90 of the Drainage Act allow the Minister to provide grants for various activities under said Act. Sections 85 and 87 make it very clear that grants are provided at the discretion of the Minister. Based on the current A.D.I.P., "lands used for agricultural purposes" may be eligible for a grant in the amount of 1/3 of their total assessment. The new policies define "lands used for agricultural purposes" as those lands eligible for the "Farm Property Class Tax Rate", "Managed Forest Tax Incentive Program", or the "Conservation Land Tax Incentive Program". The Municipal Clerk provides this information to the Engineer from the current property tax roll. Properties that do not meet the criteria are not eligible for grants. In accordance with same we expect that this project will be qualified for the grant normally available for agricultural lands. The Ministry, however, is continually reviewing their policy for grants, and we recommend that the Municipality monitor the policies, and make application to the Ministry for any grant should same become available through the A.D.I.P. program or other available funds.

When maintenance work is carried out in the future on the open drain portion, the cost for said future maintenance shall be assessed in accordance with the attached "Schedule of Assessment" excluding any Special Benefit. This Schedule shall be used for all future drain work with actual future maintenance cost shared on a pro-rata basis with the values shown in this assessment schedule.

XII. FUTURE MAINTENANCE

When maintenance work is carried out in the future on the open drain portion, the cost for said future maintenance shall be assessed in accordance with the attached Schedule of Assessment excluding any Special Benefit. When future maintenance work is carried out, the assessment to

the affected Owners shall be based on the actual future maintenance cost shared on a pro-rata basis with the values shown in this assessment schedule.

When maintenance work is carried out on any bridges in the future, we recommend that part of the cost be assessed as a Benefit to the abutting parcel served by the access bridge, and the remainder shall be assessed to the upstream lands and roads based on their affected area and outlet assessments as set out in the attached Schedule of Assessment. The share for Benefit and Outlet Liability shall be as set out in the Bridge Cost Sharing table below.

BRIDGE COST SHARING

<u>Bridge</u>	<u>Owners</u>	<u>Benefit to Owner</u>	<u>Outlet Upstream</u>
1	Michael Lutsch, (460-01000),	84.9%	15.1%
2	Thomas Halford, (460-01100),	91.5%	8.5%
3 & 4	Thomas & Linda Halford, (460-01200),	93.8%	6.2%
5	Rosemary Halford, (460-01300),	82.3%	17.7%
6	Thomas Halford, (460-01400),	81.0%	19.0%
7	Michael & Helen Lavin, (460-01500),	81.8%	18.2%
8	Ministry of Transportation, Ontario, (King's Highway No. 3),	98.0%	2.0%
9	Gerald & Agnes Lavin, (480-08410),	63.4%	36.6%
10	Canada Southern Railway, (590-01000),	98.8%	2.0%
11	Removed and Abandoned	0.0%	0.0%
12	Gerald & Agnes Lavin, (480-08400),	61.4%	38.6%
13	Count of Essex, (County Road 46),	98.0%	2.0%
14	County of Essex, (County Road 17),	98.0%	2.0%

Report - Sullivan Creek Drain
(Geographic Township of Sandwich South)
Town of Tecumseh - REI2015D010

2022-03-01

15	Kenneth & Barbara McCarthy, (520-01300),	51.9%	48.1%
16	Gerald & Agnes Lavin, (520-04700),	54.5%	45.5%
17	Ministry of Transportation, Ontario, (King's Highway No. 401),	98.0%	2.0%
18	Sandwich South Farms Ltd., (520-04500),	44.2%	55.8%
19	County of Essex, (County Road 43),	98.0%	2.0%
20	Rose Jobin, (510-01550),	43.2%	56.8%
21	Wilfred O'Neil, (510-01800),	48.7%	51.3%
22	Ruth Battersby, (510-02000),	38.0%	62.0%
23	Town of Tecumseh, (Baseline Road),	98.0%	2.0%
24	507822 Ontario Inc. & 494112 Ontario Ltd., (560-08100),	31.4%	68.6%
25	Town of Tecumseh, (12th Concession Road),	98.0%	2.0%

We recommend that the bridge structures as identified herein, be maintained in the future as part of the drainage works. We would also recommend that the access bridges in the drain, for which the future maintenance costs are to be borne by the abutting affected landowners and upstream lands and roads, be maintained by the Town and that said maintenance would include works to the bridge culvert, bedding, backfill and end treatment. Where concrete, asphalt or other decorative driveway surfaces over the bridge culverts require removal as part of the maintenance works, these surfaces should also be repaired or replaced as part of the works. Likewise, if any fencing, gate, decorative walls, guard rails or other special features exist that will be impacted by the maintenance work, they are also to be removed and restored or replaced as part of the bridge maintenance work. However, the cost of the supply and installation of any surface material other than Granular "A" material, and the cost of removal and restoration or replacement, if necessary, of any special features, shall be totally assessed to the benefiting adjoining parcel served by said access bridge.

Report - Sullivan Creek Drain
(Geographic Township of Sandwich South)
Town of Tecumseh - REI2015D010

2022-03-01

Where a bridge has a top width beyond the standard 6.1 metres (20 feet), all of the increased cost for providing the extra top width shall be assessed as a Benefit to the parcel served by the access bridge. Upstream lands and roads shall only be responsible for sharing in the cost of a standard top width access bridge.

The concrete bridge serving the Canada Southern Railway Parcel 590-0100 can be replaced by a single 1800mm diameter aluminized C.S.P. with 125X25 corrugations if desired by the owner. The pipe will need to be 24 metres long with sloped ends and quarried limestone on filter cloth protection and its invert embedded 10% of its diameter below the existing drain bottom or design bottom, whichever is lower. Should the Railway decide to proceed with doing the work themselves, the cost of construction will be borne by them, and they will only be responsible for any incidental costs that are incurred to ensure that the works are completed to the satisfaction of the Town Drainage Superintendent and in accordance with the requirements of this drainage report and bridge details set out in the Specifications and Appendices. If the maintenance of the bridge pipes is carried out by the Town, the cost sharing shall be as set out in the Bridge Cost Sharing table as noted above.

We further recommend that the maintenance cost sharing as set out above shall remain as aforesaid until otherwise determined and re-established under the provisions of the "Drainage Act, R.S.O. 1990, Chapter D.17".

All of which is respectfully submitted.

Rood Engineering Inc.



Gerard Rood, P.Eng.



tm

att.

ROOD ENGINEERING INC.

Consulting Engineers
9 Nelson Street
LEAMINGTON, Ontario N8H 1G6

SCHEDULE OF ASSESSMENT
SULLIVAN CREEK DRAIN
(Geographic Township of Sandwich South)
TOWN OF TECUMSEH

2. ONTARIO LANDS:

Tax Roll No.	Con. or Plan No.	Lot or Part of Lot	Acres Afft'd	Hectares Afft'd	Owner's Name	Value of Benefit	Value of Outlet	Value of Special Benefit	TOTAL VALUE
King's Highway 401			12.08	29.86	Ministry of Transportation Ontario	\$ 2,201.00	\$ 13,147.00	\$ 2,748.00	\$ 18,096.00
King's Highway #3			5.70	14.08	Ministry of Transportation Ontario	\$ 769.00	\$ 6,199.00	\$ 2,872.00	\$ 9,840.00
Total on Ontario Lands.....						\$ 2,970.00	\$ 19,346.00	\$ 5,620.00	\$ 27,936.00

3. MUNICIPAL LANDS:

Tax Roll No.	Con. or Plan No.	Lot or Part of Lot	Hectares Afft'd	Acres Afft'd	Owner's Name	Value of Benefit	Value of Outlet	Value of Special Benefit	TOTAL VALUE
County Road 46			2.75	6.79	County of Essex	\$ 769.00	\$ 2,989.00	\$ 1,819.00	\$ 5,577.00
County Road 17			3.17	7.83	County of Essex	\$ 549.00	\$ 3,447.00	\$ 1,750.00	\$ 5,746.00
County Road 43			5.67	14.00	County of Essex	\$ 44.00	\$ 6,164.00	\$ 1,404.00	\$ 7,612.00
Sexton Sideroad			2.22	5.49	Town of Tecumseh	\$ 439.00	\$ 2,417.00	\$ 565.00	\$ 3,421.00
Baseline Road			4.88	12.06	Town of Tecumseh	\$ 1,516.00	\$ 5,310.00	\$ 1,185.00	\$ 8,011.00
South Talbot Road			2.86	7.07	Town of Tecumseh	\$ 275.00	\$ 3,113.00	\$ 1,146.00	\$ 4,534.00
12th Concession Road			0.14	0.34	Town of Tecumseh	\$ 1,395.00	\$ 150.00	\$ 700.00	\$ 2,245.00
Total on Municipal Lands.....						\$ 4,987.00	\$ 23,590.00	\$ 8,569.00	\$ 37,146.00

4. PRIVATELY OWNED - NON-AGRICULTURAL LANDS:

Tax Roll No.	Con. or Plan No.	Lot or Part of Lot	Hectares Afft'd	Acres Afft'd	Owner's Name	Value of Benefit	Value of Outlet	Value of Special Benefit	TOTAL VALUE
460-01100	STR	298	0.190	0.47	Thomas Halford	\$ 209.00	\$ 277.00	\$ 2,809.00	\$ 3,295.00
460-01300	STR	298	0.465	1.15	Rosemary Halford	\$ 51.00	\$ 543.00	\$ 1,085.00	\$ 1,679.00
460-01800	STR	299	0.518	1.28	Frank Lafferty In Trust	\$ -	\$ 487.00	\$ 83.00	\$ 570.00
460-01801	STR	299	0.595	1.47	Ministry of Transportation	\$ -	\$ 538.00	\$ 93.00	\$ 631.00

Schedule of Assessment - Sullivan Creek Drain
 (Geographic Township of Sandwich South)
 Town of Tecumseh

Tax Roll No.	Con. or Plan No.	Lot or Part of Lot	Hectares Afft'd	Acres Afft'd	Owner's Name	Value of Benefit	Value of Outlet	Value of Special Benefit	TOTAL VALUE
480-08200	NTR	298	0.502	1.24	Alexander Chevalier & Jessie Darmon	\$ -	\$ 501.00	\$ 82.00	\$ 583.00
480-08250	NTR	298	0.178	0.44	Ali Khafaja	\$ -	\$ 244.00	\$ 39.00	\$ 283.00
480-08500	NTR	299	26.382	65.19	Joseph McCarthy	\$ 7,543.00	\$ 9,644.00	\$ 3,301.00	\$ 20,488.00
480-08611	STR	292	0.259	0.64	Ministry of Transportation	\$ -	\$ 298.00	\$ 42.00	\$ 340.00
480-08700	NTR	299	0.190	0.47	David & Margaret Pringle	\$ -	\$ 238.00	\$ 33.00	\$ 271.00
480-08750	NTR	299	0.299	0.74	Joseph & Marilyn McCarthy	\$ -	\$ 334.00	\$ 45.00	\$ 379.00
480-08801	NTR	299	4.395	10.86	Josef Dworatschek	\$ -	\$ 1,530.00	\$ 205.00	\$ 1,735.00
480-08803	NTR	299	0.405	1.00	Kevin & Melissa McCarthy	\$ -	\$ 423.00	\$ 57.00	\$ 480.00
480-08900	NTR	299	15.722	38.85	Ravinder & Mavi Singh	\$ 1,334.00	\$ 5,473.00	\$ 738.00	\$ 7,545.00
480-09010	NTR	298	0.498	1.23	Tammy & John Flood	\$ -	\$ 465.00	\$ 62.00	\$ 527.00
480-09100	NTR	298	0.210	0.52	Jason & Wendy Hill	\$ -	\$ 248.00	\$ 35.00	\$ 283.00
480-09110	NTR	298	0.210	0.52	Jacqueline Mailloux	\$ -	\$ 248.00	\$ 35.00	\$ 283.00
490-00100	NTR	300	0.401	0.99	Khmer Buddhist Santivararam Windsor 2016	\$ -	\$ 418.00	\$ 56.00	\$ 474.00
510-01590	11	13	0.680	1.68	Philip Jobin	\$ 75.00	\$ 499.00	\$ 41.00	\$ 615.00
510-02010	11	16	0.409	1.01	Laurie Knight	\$ 9.00	\$ 320.00	\$ 1.00	\$ 330.00
520-00900	10	9 & 10	0.405	1.00	Hardershan Brar	\$ -	\$ 420.00	\$ 57.00	\$ 477.00
520-01000	10	10	0.045	0.11	Union Gas Limited	\$ 2.00	\$ 82.00	\$ 10.00	\$ 94.00
520-01100	10	10	0.405	1.00	Guy & Tina Robertson	\$ 13.00	\$ 412.00	\$ 57.00	\$ 482.00
520-01210	10	11	0.421	1.04	Charles Matthews	\$ 46.00	\$ 409.00	\$ 57.00	\$ 512.00
520-01301	10	12	0.773	1.91	Barbara McCarthy	\$ 25.00	\$ 549.00	\$ 46.00	\$ 620.00
520-01350	10	12	0.469	1.16	Roger Lemmon	\$ 5.00	\$ 421.00	\$ 35.00	\$ 461.00
520-03400	10	16	0.089	0.22	Joseph & Helen Diesbourg	\$ -	\$ 102.00	\$ -	\$ 102.00
520-03800	10	16	0.101	0.25	Jacob Carlesimo	\$ -	\$ 114.00	\$ -	\$ 114.00
520-03901	10	16	0.405	1.00	Clifford & Connie Campeau	\$ -	\$ 317.00	\$ 1.00	\$ 318.00
520-03920	10	15	0.271	0.67	Herbert Henricks & Marianne Scarpelli	\$ 3.00	\$ 234.00	\$ 1.00	\$ 238.00
520-04250	10	15	0.502	1.24	Jeremy Knezev	\$ 6.00	\$ 354.00	\$ 1.00	\$ 361.00
520-04300	10	15	0.405	1.00	Luigina Gobbo	\$ 4.00	\$ 317.00	\$ 1.00	\$ 322.00
520-04550	10	13	0.251	0.62	Brian Chittle	\$ 28.00	\$ 245.00	\$ 21.00	\$ 294.00
520-04600	10	13	0.656	1.62	Steno Novelletto & Rosanne St.Louis	\$ 36.00	\$ 489.00	\$ 39.00	\$ 564.00
520-04750	10	12	0.506	1.25	Thomas & Mary Moore	\$ -	\$ 419.00	\$ 35.00	\$ 454.00

Schedule of Assessment - Sullivan Creek Drain
 (Geographic Township of Sandwich South)
 Town of Tecumseh

Tax Roll No.	Con. or Plan No.	Lot or Part of Lot	Hectares Afft'd	Acres Afft'd	Owner's Name	Value of Benefit	Value of Outlet	Value of Special Benefit	TOTAL VALUE
530-04800	9	10	0.405	1.00	Lee Simpson	\$ 22.00	\$ 417.00	\$ 57.00	\$ 496.00
560-08500	18	12	0.405	1.00	Mario & Deana Liburdi	\$ 584.00	\$ 174.00	\$ -	\$ 758.00
560-00300	10	17	1.012	2.50	Crossway Church	\$ -	\$ 581.00	\$ 2.00	\$ 583.00
560-04000	11	17	15.929	39.36	Norman, Rose, Philip & Paul Jobin	\$ 9,173.00	\$ 4,090.00	\$ 12.00	\$ 13,275.00
560-04010	11	17	0.490	1.21	Derek Battersby & Brittney Brown	\$ -	\$ 345.00	\$ 1.00	\$ 346.00
Windsor									
030-06300	10	16	0.409	1.01	Robert & Judy-Ann Coupe	\$ -	\$ 309.00	\$ 1.00	\$ 310.00
030-06400	1351	45 & 46	0.134	0.33	Thomas Crouchman	\$ -	\$ 136.00	\$ -	\$ 136.00
030-06500	1351	47	0.235	0.58	Gregory Maxwell	\$ -	\$ 208.00	\$ 1.00	\$ 209.00
030-06700	10	16	0.138	0.34	Rousian Rakhoutine & Lilia Demeneva	\$ -	\$ 140.00	\$ -	\$ 140.00
Total on Privately Owned - Non-Agricultural Lands.....						\$ 19,168.00	\$ 34,012.00	\$ 9,277.00	\$ 62,457.00

5. PRIVATELY OWNED - AGRICULTURAL LANDS (grantable):

460-01000	STR	297	8.09	20.00	Michael Lutsch	\$ 2,458.00	\$ 2,980.00	\$ 1,026.00	\$ 6,464.00
460-01200	STR	298	13.58	33.55	Thomas & Linda Halford	\$ 2,256.00	\$ 5,495.00	\$ 1,874.00	\$ 9,625.00
460-01400	STR	298	10.52	26.00	Thomas Halford	\$ 2,121.00	\$ 4,213.00	\$ 1,708.00	\$ 8,042.00
460-01500	STR	298	16.19	40.00	Michael & Helen Lavin	\$ 7,750.00	\$ 6,340.00	\$ 1,996.00	\$ 16,086.00
460-01600	STR	299	20.23	50.00	John Lafferty	\$ 7,750.00	\$ 7,837.00	\$ 1,223.00	\$ 16,810.00
460-01601	STR	299	0.17	0.43	Frank & Catherine Lafferty	\$ -	\$ 224.00	\$ 39.00	\$ 263.00
460-01700	STR	299	0.43	1.07	Frank Lafferty Limited	\$ -	\$ 437.00	\$ 74.00	\$ 511.00
460-01900	STR	299	14.08	34.78	Catherine Lafferty	\$ -	\$ 4,900.00	\$ 849.00	\$ 5,749.00
460-01901	STR	299	11.85	29.27	538073 Ontario Inc.	\$ 1,140.00	\$ 4,407.00	\$ 717.00	\$ 6,264.00
460-02000	STR	299	11.74	29.00	Catherine Lafferty & Mary Thompson	\$ 6,840.00	\$ 4,443.00	\$ 710.00	\$ 11,993.00
460-02100	STR	298	9.71	24.00	538073 Ontario Inc.	\$ 7,496.00	\$ 6,205.00	\$ 587.00	\$ 14,288.00
480-08300	NTR	298	41.68	102.98	Sandwich South Farms Inc.	\$ 2,924.00	\$ 14,418.00	\$ 2,404.00	\$ 19,746.00
480-08400	NTR	298	7.52	18.58	Gerald & Agnes Lavin	\$ 6,315.00	\$ 2,634.00	\$ 1,091.00	\$ 10,040.00
480-08410	NTR	298	18.47	45.65	Gerald & Agnes Lavin	\$ 10,219.00	\$ 6,673.00	\$ 1,114.00	\$ 18,006.00

Schedule of Assessment - Sullivan Creek Drain
 (Geographic Township of Sandwich South)
 Town of Tecumseh

Tax Roll No.	Con. or Plan No.	Lot or Part of Lot	Hectares Afft'd	Acres Afft'd	Owner's Name	Value of Benefit	Value of Outlet	Value of Special Benefit	TOTAL VALUE
480-08600	NTR	299	12.61	31.15	Richard McCarthy	\$ 183.00	\$ 4,389.00	\$ 673.00	\$ 5,245.00
480-08800	NTR	299	19.83	49.00	538073 Ontario Inc.	\$ 2,867.00	\$ 7,119.00	\$ 1,071.00	\$ 11,057.00
480-09000	NTR	298	10.32	25.51	Rose M, Philip N, & Paul J. Jobin & Joie Reyner	\$ -	\$ 3,572.00	\$ 485.00	\$ 4,057.00
490-10200	NTR	300	1.62	4.00	538073 Ontario Inc.	\$ -	\$ 1,014.00	\$ 137.00	\$ 1,151.00
490-10300	NTR	300	19.49	48.16	Robert & Richard McCarthy	\$ -	\$ 6,785.00	\$ 917.00	\$ 7,702.00
510-01500	11	13	16.41	40.54	Norman, Rose, Philip, Paul, Joie & Joslyne Jobin	\$ 1,503.00	\$ 4,855.00	\$ 399.00	\$ 6,757.00
510-01550	11	13	6.37	15.75	Rose Jobin	\$ 3,467.00	\$ 1,858.00	\$ 660.00	\$ 5,985.00
510-01600	11	14	16.42	40.57	Paul & Rose Jobin	\$ 4,776.00	\$ 4,716.00	\$ 385.00	\$ 9,877.00
510-01610	11	14	0.40	0.99	Philip Jobin	\$ 54.00	\$ 350.00	\$ 28.00	\$ 432.00
510-01700	11	14	8.09	20.00	Wilfred O'Neil	\$ 4,010.00	\$ 2,307.00	\$ 190.00	\$ 6,507.00
510-01800	11	15	8.09	20.00	Wilfred O'Neil	\$ 3,870.00	\$ 2,272.00	\$ 17,087.00	\$ 23,229.00
510-01900	11	15	8.09	20.00	Wilfred O'Neil	\$ 3,615.00	\$ 2,254.00	\$ 13.00	\$ 5,882.00
510-02000	11	15	15.99	39.50	Ruth Battersby	\$ 9,160.00	\$ 4,382.00	\$ 476.00	\$ 14,018.00
510-02005	11	15	0.20	0.50	James Battersby	\$ 7.00	\$ 193.00	\$ 1.00	\$ 201.00
510-02100	11	16	22.26	55.00	Helene Battersby	\$ 12,948.00	\$ 5,908.00	\$ 18.00	\$ 18,874.00
520-00700	10	10	21.19	52.36	Rose Jobin	\$ 1,267.00	\$ 7,192.00	\$ 993.00	\$ 9,452.00
520-00750	10	10	20.29	50.13	Rose, Philip & Paul Jobin & Jobin Farms Inc.	\$ 1,204.00	\$ 6,974.00	\$ 950.00	\$ 9,128.00
520-01300	10	11 & 12	48.39	119.56	Kenneth & Barbara McCarthy	\$ 26,220.00	\$ 15,371.00	\$ 3,703.00	\$ 45,294.00
520-03500	10	16	8.50	21.00	Clifford & Connie Campeau	\$ -	\$ 2,219.00	\$ 6.00	\$ 2,225.00
520-03900	10	16	11.01	27.20	Clifford & Connie Campeau	\$ -	\$ 2,874.00	\$ 8.00	\$ 2,882.00
520-04000	10	15	9.85	24.33	Susanna MacKenzie-Russell	\$ 69.00	\$ 2,571.00	\$ 7.00	\$ 2,647.00
520-04100	10	15	9.92	24.50	Sanward Enterprises Inc.	\$ 83.00	\$ 2,589.00	\$ 7.00	\$ 2,679.00
520-04200	10	15	19.33	47.76	Edward Chittle Jr.	\$ 109.00	\$ 5,047.00	\$ 14.00	\$ 5,170.00
520-04400	10	14	40.47	100.00	Norman Jobin	\$ 545.00	\$ 11,535.00	\$ 951.00	\$ 13,031.00
520-04500	10	12 & 13	40.41	99.85	Sandwich South Farms Ltd.	\$ 11,406.00	\$ 12,133.00	\$ 1,634.00	\$ 25,173.00
520-04700	10	12	63.13	156.00	Gerald & Agnes Lavin	\$ 8,290.00	\$ 19,506.00	\$ 15,736.00	\$ 43,532.00
520-04800	10	11	30.35	75.00	Wayne & Carol O'Neil	\$ 50.00	\$ 9,510.00	\$ 1,330.00	\$ 10,890.00
530-00100	9	10	25.90	64.00	Diklich Capital Corp	\$ 9,489.00	\$ 8,791.00	\$ 1,215.00	\$ 19,495.00
560-03900	10	17	2.41	5.95	Susanna Mackenzie	\$ -	\$ 629.00	\$ 2.00	\$ 631.00
530-04770	9	11	0.27	0.66	Sanward Enterprises Inc.	\$ 15.00	\$ 293.00	\$ 42.00	\$ 350.00

Schedule of Assessment - Sullivan Creek Drain
 (Geographic Township of Sandwich South)
 Town of Tecumseh

Tax Roll No.	Con. or Plan No.	Lot or Part of Lot	Hectares Afft'd	Acres Afft'd	Owner's Name	Value of Benefit	Value of Outlet	Value of Special Benefit	TOTAL VALUE
530-04775	9	11	0.30	0.74	Edward Chittle Jr.	\$ 33.00	\$ 321.00	\$ 45.00	\$ 399.00
560-08000	11	18	0.40	1.00	Mary McGraw	\$ 1,008.00	\$ 99.00	\$ -	\$ 1,107.00
560-08100	11	17	16.19	40.00	507822 Ontario Inc. & 494112 Ontario Limited	\$ 6,761.00	\$ 4,086.00	\$ 383.00	\$ 11,230.00
560-08200	11	17	8.09	20.00	Phyllis Battersby, Wendy Philips & Cindy Walton	\$ 2,824.00	\$ 2,043.00	\$ -	\$ 4,867.00
Windsor									
030-04700	10	12	2.19	5.40	Sandwich South Farms Ltd.	\$ 159.00	\$ 856.00	\$ 2.00	\$ 1,017.00
030-04800	10	12 & 13	6.59	16.28	1027414 Ontario Inc.	\$ -	\$ 1,720.00	\$ 5.00	\$ 1,725.00
030-05000	10	13	16.19	40.00	Rose Jobin	\$ -	\$ 4,227.00	\$ 12.00	\$ 4,239.00
030-05200	10	13	8.09	20.00	John Wilson	\$ -	\$ 2,113.00	\$ 6.00	\$ 2,119.00
030-05400	10	14	15.38	38.00	Norbert St.Louis	\$ -	\$ 4,015.00	\$ 11.00	\$ 4,026.00
030-05600	10	14	11.74	29.00	Gerald Lavin	\$ -	\$ 3,064.00	\$ 9.00	\$ 3,073.00
030-05850	10	15	6.07	15.00	2017345 Ontario Limited	\$ -	\$ 1,585.00	\$ 5.00	\$ 1,590.00
030-06000	10	15	6.07	15.00	1741077 Ontario Inc.	\$ -	\$ 1,585.00	\$ 5.00	\$ 1,590.00
030-06110	10	15	11.41	28.20	1583925 Ontario Limited	\$ -	\$ 2,980.00	\$ 9.00	\$ 2,989.00
030-06200	10	16	2.01	4.96	2187065 Ontario Ltd.	\$ -	\$ 524.00	\$ 1.00	\$ 525.00
030-06600	1351	48	10.36	25.59	Joseph & Brenda Gagnon	\$ -	\$ 2,704.00	\$ 8.00	\$ 2,712.00
Total on Privately Owned - Agricultural Lands (grantable).....						\$ 173,261.00	\$ 262,336.00	\$ 65,051.00	\$ 500,648.00
5. PRIVATELY OWNED - AGRICULTURAL LANDS (non-grantable):									
590-01000	STR	298, 299, 300	2.83	7.00	Canada Southern Railway Co.	\$ 857.00	\$ 999.00	\$ 1,332.00	\$ 3,188.00
590-01200	NTR	298	0.70	1.74	Town of Tecumseh	\$ 31.00	\$ 347.00	\$ 47.00	\$ 425.00
Total on Privately Owned - Agricultural Lands (non-grantable).....						\$ 888.00	\$ 1,346.00	\$ 1,379.00	\$ 3,613.00
TOTAL ASSESSMENT			943.29	2330.88		\$ 201,274.00	\$ 340,630.00	\$ 89,896.00	\$ 631,800.00

=====

1 Hectare = 2.471 Acres
 Project No. REI2015D010
 March 1st, 2022

SPECIFICATIONS

SULLIVAN CREEK DRAIN

(Geographic Township of Sandwich South)

TOWN OF TECUMSEH

I. GENERAL SCOPE OF WORK

The Sullivan Creek Drain currently comprises of an open drain with the upper end generally located approximately 740 metres east of Sexton Road and 400 metres south of County Road 46, it meanders northeasterly for approximately 5 km where it outlets to the Pike Creek Drain at a point approximately 760 metres north of Baseline Road and 480 metres west of County Road 19 respectively, in the geographic township of Sandwich South, Town of Tecumseh. The work on the drain will extend from the outlet as noted on the plans and proceed southerly to the upstream end of the open drain. The work under this project generally comprises of improvements to the open drain to provide a suitable cross section for conveyance of flows, along with removal of a farm bridge along the course of the drain. The installation of two new replacement bridges has already been completed due to emergency needs. The work on the bridge being taken out includes the removal and disposal of all existing deck structure including the poured concrete abutment walls and the removal of any other materials to allow for the drain open cross section to be restored. Work on the drain includes supply and installation of quarried limestone on filter cloth general erosion protection and rock chute inlets. The proposed work is intended to address the repair and improvement of the open drain, tile end improvements, bridge repairs and improvements including headwall work and erosion protection in accordance with current standards.

All work shall be carried out in accordance with these specifications, the plans forming part of this drainage project, as well as the Standard Details included in **Appendix "REI-C"**. All work carried out under this project shall be completed to the full satisfaction of the Town Drainage Superintendent and the Consulting Engineer.

II. E.R.C.A. AND D.F.O. CONSIDERATIONS

The Contractor will be required to implement stringent erosion and sedimentation controls during the course of the work to help minimize the amount of silt and sediment being carried downstream into the Pike Creek Drain. It is intended that work on this project be carried out during relatively dry weather to ensure proper site and drain conditions and to avoid conflicts with sediment being deposited into the outlet drainage systems. All disturbed areas shall be restored as quickly as possible with grass seeding and mulching installed to ensure a protective cover and to minimize any erosion from the work sites subsequent to construction. The Contractor may be required to provide temporary silt fencing and straw bales as outlined further in these specifications.

All of the work shall be carried out in accordance with any permits or authorizations issued by the Essex Region Conservation Authority (E.R.C.A.) or the Department of Fisheries and Oceans (D.F.O.), copies of which will be provided, if available, and the notes in **Appendix "REI-A"**. The Contractor is advised that **no work** may be carried out in the existing drain **from March 15th to July 15th** of any given year because the drain is directly connected to a downstream drain that is classified as sensitive to impacts on aquatic life and habitat by E.R.C.A. and D.F.O. and Largemouth Bass may be present as advised by D.F.O.

As part of its work, the Contractor will implement the following measures that will ensure that any potential adverse effects on fish and fish habitat will be mitigated:

- a) As per standard requirements, work will not be conducted at times when flows in the drain are elevated due to local rain events, storms, or seasonal floods. Work will be done in the dry.
- b) All disturbed soils on the drain banks and within the channel, including spoil, must be stabilized immediately upon completion of work. The restoration of the site must be completed to a like or better condition to what existed prior to the works. The spoil material must be hauled away and disposed of at a suitable site, or spread an appropriate distance from the top of the drain bank to ensure that it is not washed back into the drain.
- c) To prevent sediment entry into the Drain, in the event of an unexpected rainfall, silt barriers and/or traps must be placed in the channel during the works and until the site has been stabilized. All sediment and erosion control measures are to be in accordance with related Ontario Provincial Standards. It is incumbent on the proponent and their Contractors to ensure that sediment and erosion control measures are functioning properly and are maintained and upgraded as required.
- d) Silt or sand accumulated in the barrier traps must be removed and stabilized on land once the site is stabilized.
- e) All activities including maintenance procedures should be controlled to prevent the entry of petroleum products, debris, rubble, concrete, or other deleterious substances into the water. Vehicular refuelling and maintenance should be conducted away from the water.
- f) The Contractor shall construct six (6) sediment/refugia pools along the lower portion of the drain located near Stations 3+360, 4+360, 5+360, 6+360, 7+360 and 8+360. Each pool shall be centred in the drain and be 3 metres long and 300mm deep with 1:1 side slopes with a minimum bottom width of 600mm for drain design bottom width of 1.2m, and 800mm for drain design bottom width of 1.4m.

III. M.N.R.F. – M.E.C.P. CONSIDERATIONS

The Contractor is to note that this project has gone through the Ministry of Natural Resources and Forestry (M.N.R.F.) screening process by way of a Species at Risk (S.A.R.) review of the Mitigation Plan for Drainage Works (March 2018-17-4938) that the Town has prepared to address the Endangered Species Act, 2007, that is now administered by the Ministry of Environment, Conservation and Parks (M.E.C.P.). Section 6.0 of the Mitigation Plan indicates that snake species are a concern for this work area and although turtles are not indicated, they are mobile and could be encountered. The Mitigation Plan includes measures to be followed as outlined in “Section 7.0 Mitigation Measures” of the document and a copy of same as it relates to turtles and snakes is included in **Appendix “REI-B”**. Providing mitigation requirements are implemented, it was concluded that present wildlife Species at Risk will be protected from negative impacts and the works will not contravene Section 9 (species protection) or Section 10 (habitat protection) of the Endangered Species Act, 2007. Based on this information we find that the Town can proceed with the eligible repairs, maintenance, and improvements to the drain as they are exempt under Sections 9 and 10 of the Act, provided that they follow the rules within Ontario Regulation 242/08 and the Mitigation Measures in their S.A.R. Mitigation Plan. To address these requirements the Town has established comprehensive mitigation measures as well as species identification guides for reference. The results of the review will be provided to the Contractor and copies of the mitigation measures, habitat protection and identification sheets will be included within **Appendix “REI-B”**.

The Contractor is to review **Appendix “REI-B”** in detail and is required to comply, in all regards, with the contents of said M.N.R.F. information, or any future requirements, and follow the special

requirements therein included, during construction. The Drainage Superintendent has reviewed the endangered species maps and any concerns will be provided in **Appendix “REI-B”**. Certain species such as turtles and snakes are mobile and may be encountered during construction. Therefore, the Mitigation Measures in Section 7.0 of the Town Plan has been included in **Appendix “REI-B”** in its entirety along with timing window charts for further information and use by the Contractor.

The Contractor shall contact the Drainage Superintendent if an endangered species is encountered during construction. The Contractor shall be responsible for providing the necessary equipment and materials outlined in the **“MITIGATION PLAN”** to address the handling of any endangered species encountered during the course of the construction work. The Contractor shall cooperate fully and assist the Drainage Superintendent or M.N.R.F. – M.E.C.P. staff in the proper handling of the endangered species as outlined in the **“MITIGATION PLAN”**, and as may be further directed by the Drainage Superintendent or the M.N.R.F. – M.E.C.P. staff and shall govern all its operations accordingly.

IV. ACCESS TO WORK

The Contractor is advised that the majority of the work to be carried out on this project extends along the north and west side of the Sullivan Creek Drain except for the portion between Bridge 19 and 20 that will be completed from the east side and from Highway No. 3 to County Road 46 along the easterly side. For the lawn areas in front of MN 5580, 5660 and 5680, the Contractor shall carry out its work from the roadside and load up and haul away and dispose of the excavated material and any material from cleaning out the culverts located in the drain. Where lands on both sides of the drain belong to the same landowner, the landowner may request work to be done from the other side of the drain and the Contractor shall coordinate this with the landowner. The Contractor shall have access for a minimum width of 8 metres (26 feet) abutting the proposed drainage works. The Contractor may utilize the work area as necessary, to permit the completion of all of the work required to be carried out for this project along with an area sufficient to spread the excavated material to a maximum depth of 100mm on the adjacent lands beyond any grass buffer or driveway access. The Contractor shall also have access through the driveways from the roads along the works as necessary to access the open drain and carry out the replacement and removal and repair of the existing access bridges as set out on the plans and in these specifications, along with a sufficient area in the vicinity of the bridges to carry out the improvements of the structure and ancillary work.

The Contractor shall ensure that the traveling public is protected at all times while utilizing the roadway for its access. The Contractor shall provide traffic control, including flag persons when required.

Throughout the course of the work it is imperative that the Contractor protect as much landscaping and vegetation as possible when accessing along the drain. This will be of particular concern along the grass buffer and driveway areas abutting the drain. Any accesses or areas used in carrying out the works are to be fully restored to their original conditions by the Contractor at its cost, including topsoil placement and lawn restoration as directed by the Town Drainage Superintendent and the Consulting Engineer. Restoration shall include but not be limited to all necessary levelling, grading, shaping, topsoil placement, seeding, mulching, and granular placement required to make good any damage caused.

V. REMOVAL OF BRUSH, TREES AND RUBBISH

Where there is any brush, trees or rubbish along the course of the drainage works from top of bank to top of bank, including the full width of the work access, all such brush, trees or rubbish shall be close cut and grubbed out, and the whole shall be chipped up for recycling, burned or

otherwise satisfactorily disposed of by the Contractor. The brush and trees removed along the course of the work are to be cut as close to the ground as practicable and within the drain banks parallel to the side slopes. Except as noted herein, stumps shall be left in place and shall be sprayed with a single application of stump killer (Diphenoprop BK700 or approved equal). Dead trees on the top of each bank and any trees or tree branches that overhang the drain shall be removed and trimmed. All removed materials shall be put into piles by the Contractor in locations adjacent to the drain and within the working corridors, where they can be safely chipped and disposed of, or burned by it, or hauled away and disposed of by the Contractor to a site to be obtained by it at its expense. In all cases, trees and brush shall be stockpiled on the property on which they were cut. Prior to and during the course of any burning operations, the Contractor shall comply with the guidelines prepared by the Air Quality Branch of the Ontario Ministry of the Environment, and shall ensure that the Environmental Protection Act is not violated. The Contractor shall assume all responsibility for control of the burn, obtaining all utility locates in the area of each burn site, all responsibility for liabilities related to the burning of the brush and smoke generated, and will be required to notify the local fire authorities to obtain any permits and co-operate with them in the carrying out of any work. The removal of brush and trees shall be carried out in close consultation with the Town Drainage Superintendent or Consulting Engineer to ensure that no decorative trees or shrubs are disturbed by the operations of the Contractor that can be saved. It is the intent of this project to save as many trees and bushes as practical on private lands adjacent to the drain and within the working corridors, especially mature trees beyond the drain sideslopes.

The Contractor shall protect all other trees, bushes, and shrubs located along the length of the drainage works except for those trees that are established, in consultation with the Town Drainage Superintendent, the Consulting Engineer, and the Owners, to be removed as part of the works. The Contractor shall note that protecting and saving the trees may require the Contractor to carry out hand work around the trees, bushes, and shrubs to complete the necessary final site grading and restoration.

Following the completion of the work, the Contractor is to trim up any broken or damaged limbs on trees which are to remain standing, and it shall dispose of said branches along with other brush, thus leaving the trees in a neat and tidy condition.

The Contractor shall remove all deleterious materials and rubbish along the course of the open drain and any such materials located in the bridge culverts and enclosures while carrying out its cleaning of same. All such deleterious materials and rubbish shall be loaded up and hauled away by the Contractor to a site to be obtained by it at its cost in accordance with excess materials regulations.

VI. FENCING

Where it is necessary to take down any fence to proceed with the work, the same shall be done by the Contractor across or along that portion of the work where such fence is located. The Contractor will be required to exercise extreme care in the removal of any fencing so as to cause a minimum of damage to same. The Contractor will be required to reinstall any fence that is taken down in order to proceed with the work, and the fence shall be reinstated in a neat and workmanlike manner. The Contractor will not be required to procure any new materials for rebuilding the fence provided that it has used reasonable care in the removal and replacement of same. When any fence is removed by the Contractor, and the Owner thereof deems it advisable and procures new material for replacing the fence so removed, the Contractor shall replace the fence using the new materials and the materials from the present fence shall remain the property of the Owner.

VII. DETAILS OF OPEN DRAIN WORK

The open drain shall be excavated to the lines, levels, grades, and cross-sections as shown on the accompanying drawings, or as may be further established by the Town Drainage Superintendent

or the Engineer at the time of the work. The drain shall be carefully excavated so as not to disturb the existing banks, rock protection and vegetation, except for those portions of the drain where widening or restoration of a stable drain bank configuration is required. The bottom width of the drain and the sideslopes of the excavation shall conform to the dimensions given on the drawings.

The Contractor is advised that there is a high pressure gas line crossing under the drain just south of County Road 46 and this will require the Contractor to coordinate with Enbridge Union Gas for 3rd party inspection when working within 30m (100') of the gas line crossing. The Contractor will be responsible to arrange for the necessary locates of all utilities in the vicinity of the drain along its complete length and shall take appropriate steps to protect them during the course of its works on the drain.

The drain shall be of the size, type, depth, etcetera as shown on the accompanying drawings. When completed, the drain shall have a uniform and even bottom and in no case shall such bottom project above the grade line, as shown on the accompanying drawings, and as determined from the Benchmarks. The finished side slopes of the drain shall be 1.5 metres horizontal to 1.0 metre vertical.

The excavated material to be cast onto the adjoining lands shall be well and evenly spread over a sufficient area so that no portion of the excavated earth is more than 100mm in depth. The material shall be kept at least 1.2 metres clear from the finished edge of the drain, care being taken not to fill up any existing tiles, ditches, furrows or drains with the excavated material. The excavated material to be spread upon the lands shall be free from rocks, cobbles, boulders, stumps, rubble, rubbish or other similar material and these materials, if encountered, shall be hauled away by the Contractor and disposed of at a site to be obtained by it at its expense.

Where the drain crosses any lawn, garden, orchard, parking, roadway or driveway areas, the excavated material for the full width of the above-mentioned areas shall be hauled away by the Contractor and disposed of to a site to be obtained by the Contractor at its expense. All work at the disposal site shall be established between the Contractor and the site owner. The Contractor shall be responsible for any permits required and shall provide copies of same to the Town and Consulting Engineer when requested and comply with excess soil management regulations.

Where there is any brush or rubbish in the course of the drain, including both side slopes of the drain, all such brush or rubbish shall be close cut and grubbed out. Where there is any brush or rubbish where the earth is to be spread, or on that strip of land between where the earth is to be spread and the edge of the drain, all such brush or rubbish shall be close cut and grubbed out. The whole is to be burned, chipped, or otherwise satisfactorily disposed of by the Contractor.

VIII. DETAILS OF BRIDGE WORK

The Contractor shall completely remove and dispose of Bridge 11 at the north side of the former railway property. The Contractor shall load up and haul away all deleterious material from the bridge site as set out further in these specifications. The drain cross section in the location of the bridge shall be restored in accordance with the profile and the new exposed banks restored as noted in these specifications.

For future works the existing concrete, steel or H.D.P.E. pipes shall be removed and disposed of by the Contractor, along with any other deleterious materials that are encountered. The bridge shall be replaced in accordance with the profile and detail plans including the 10% embedment and the new exposed banks restored as noted in these specifications.

The Contractor will be responsible to restore any damage caused to the roadways at its cost. All damaged hard surface roadway areas shall be neatly saw cut and the damaged materials removed and disposed of by the Contractor prior to carrying out any restoration work. The extent of the repairs shall be established in consultation with the Town Drainage Superintendent, the Road Authority, and the Consulting Engineer and the repairs shall be completed to their full satisfaction.

The Contractor is to note that any intercepted tiles or pipes along the length of the future replacement culverts are to be extended and connected through rock protection at its cost unless otherwise noted in the accompanying drawings.

IX. CORRUGATED STEEL PIPE INSTALLATION

The new corrugated steel pipe (CSP) to be installed on this project is required to be provided in the longest lengths that are available and shall not be less than 3.0 metres. Where the overall access pipe length exceeds the standard pipe lengths, the Contractor shall connect the pipe sections together by use of a manufactured 9-C bolted coupler installed in accordance with the manufacturer's recommendations. All coupler joints shall be wrapped with a layer of filter cloth around the complete circumference so that it extends a minimum of 100mm beyond the coupler on each end, to ensure a positive seal against soil migration through the joints.

The Contractor shall note that the placement of any new culvert pipe shall be performed totally in the dry and it shall be prepared to take whatever steps are necessary to ensure same, all to the full satisfaction of the Town Drainage Superintendent or the Consulting Engineer. As part of the work, the Contractor will be required to clean out the drain along the full length of the pipe and for a distance of 3.05 metres (10 ft.) upstream and downstream of the pipe. The Contractor shall note that the pipe inverts are set at least 10% of the pipe diameter (or the pipe rise) below the drain bottom to provide the embedment required by E.R.C.A. and D.F.O. and to meet the minimum cover requirements for the pipe.

The installation of the complete length of the new culvert pipe, including all appurtenances, shall be completely inspected by the Town Drainage Superintendent or the Consulting Engineer's Inspector prior to backfilling any portions of same. Under no circumstance shall the Contractor commence the construction or backfill of the new culvert pipe without the site presence of the Town Drainage Superintendent or the Consulting Engineer's Inspector to inspect and approve said installation. The Contractor shall provide a minimum of two (2) working days' notice to the Town Drainage Superintendent or the Consulting Engineer prior to commencement of the work. The installation of the new culvert structure is to be performed during normal working hours of the Town Drainage Superintendent and the Consulting Engineer from Monday to Friday unless written authorization is provided by them to amend said working hours.

For the access bridge installation, once the new aluminized steel type II corrugated pipe has been satisfactorily set in place, the Contractor shall completely backfill same with granular material M.T.O. Type "B" O.P.S.S. Form 1010 with the following exception. The top 305mm (12") of the backfill material for the full top width of the access, and the full top width of the drain or the excavated trench, and any approaches to the south and transitions to the north shall be granular material M.T.O. Type "A" O.P.S.S. Form 1010. All of the driveway approach areas extending from the Town roadway to the south face of the new bridge culvert shall be backfilled with compacted granular material M.T.O. Type "A" O.P.S.S. Form 1010, but only after all topsoil material has been completely removed and disposed of, and the minimum thickness of this granular material shall be 305mm (12"). All areas outside of the access driveway shall be backfilled with native material compacted to 96% of Standard Proctor Density and topped with a minimum of 50mm of topsoil and shall be seeded and mulched.

For hard surface driveway crossings, the top 305mm (12") of the backfill over the pipe below the hard surface treatment shall comprise granular material M.T.O. Type "A" O.P.S.S. Form 1010 compacted to a minimum of 100% Standard Proctor Density. The Contractor shall at all times be very careful when performing its backfilling and compaction operations so that no damage is caused to the pipe. To ensure that no damage is caused to the proposed pipe, alternative methods of achieving the required backfill compaction shall be submitted to the Consulting Engineer or the Town Drainage Superintendent for their approval prior to the commencement of this work. The Contractor shall restore the asphalt surface by placing a minimum of the existing thickness or a 90mm minimum thickness of Type HL-4 hot mix asphalt. The asphalt shall be supplied and placed

in two (2) approximately equal lifts compacted to a value ranging from 92% to 96% of maximum relative density as per O.P.S.S. 310. For existing concrete driveways, the Contractor shall carefully remove the concrete to the nearest expansion joint. The concrete driveway shall be restored to the original length and width that was removed and include 150mm thick, 30mPa concrete, with 6% ±1% air entrainment and 6x6-6/6 welded wire fabric reinforcing installed at the midpoint of the slab. All slab surfaces shall be finished to provide an appearance approximating the finish on the existing concrete driveway abutting the replacement.

The Contractor will be responsible to restore any damage caused to the roadways at its cost. All damaged hard surface roadway areas shall be neatly saw cut and the damaged materials removed and disposed of by the Contractor prior to carrying out any restoration work. The extent of the repairs shall be established in consultation with the Town Drainage Superintendent, the Road Authority, and the Consulting Engineer and the repairs shall be completed to their full satisfaction.

The Contractor is to note that any intercepted pipes or tiles along the length of the proposed culvert are to be extended and connected at its cost to the open drain at the end of the new culvert unless otherwise noted in the accompanying drawings.

The Contractor shall also note that the placing of the new access bridge culvert shall be completed so that it totally complies with the parameters established and noted in the Bridge Details and Tables for the culvert replacement. The culvert shall be set on an even grade and the placement shall be performed totally in the dry, and the Contractor should be prepared to take whatever steps are necessary to ensure same, all to the full satisfaction of the Town Drainage Superintendent or the Consulting Engineer. The Contractor shall also be required to supply a minimum of 100mm (4") of 20mm (3/4") clear stone bedding underneath the culvert pipe extending from the bottom of the drain to the culvert invert grade, all to the full satisfaction of the Town Drainage Superintendent or the Consulting Engineer. Furthermore, if an unsound base is encountered, it must be removed and replaced with 20mm (3/4") clear stone satisfactorily compacted in place to the full satisfaction of the Town Drainage Superintendent or the Consulting Engineer. The Contractor is to note that when replacing an access bridge or enclosure culvert, it shall be required to excavate a trench having a width not less than the new pipe outside diameter plus a 600mm working width on both sides of the new pipe to allow for proper installation of granular backfill and compaction of same. The Contractor shall also note that all culvert pipe installations are to be carried out with a minimum of 10% of their diameter or rise embedded below the drain design bottom, as shown and noted on the plan for each of the access bridge installations.

X. REMOVALS

Where existing access bridges and enclosures are to be completely removed and replaced, the Contractor shall be required to excavate and completely extract the existing concrete structure or culvert pipe and the existing endwalls in their entirety, as well as any other deleterious materials that may be encountered in removing same, excluding poured concrete headwalls that are to be reused. The Contractor shall neatly saw cut any concrete or asphalt surfaces over the pipes for a sufficient width to allow for the safe removal of same or go to the nearest expansion joint panel of the concrete driveways. The Contractor shall also be required to completely dispose of all removed materials to a site to be obtained by it at its own expense. The Contractor shall note that when headwalls are shown to be left in place, the Contractor shall protect same and carry out its work for the pipe replacement as noted above and dispose of any debris resulting from the work.

All unsuitable and deleterious materials from the excavation and removal of the existing bridge and enclosure culverts and drain cleaning shall be hauled away and disposed of by the Contractor to a site to be obtained by it at its expense. Likewise, any material excavated to allow for the granular approaches to the bridge, driveway transitions, or installation of new headwalls shall also be hauled away and disposed of by the Contractor.

XI. CONCRETE FILLED JUTE BAG, PRECAST CONCRETE BLOCK OR SLOPED END PROTECTION

Unless otherwise shown or noted, the Contractor is to provide new concrete filled jute bag headwalls, precast concrete block, or sloped quarried limestone on non-woven filter cloth end protection for the access bridges and enclosures being replaced or constructed on this drain.

The concrete filled jute bags are to be provided and laid out as is shown and detailed in the drawings provided by the Town and as noted in the Standard Specifications in **Appendix "REI-C"**. In all cases, the concrete filled jute bag headwalls shall be topped with a minimum 100mm (4") thick continuous concrete cap comprising 30MPa concrete with 6% ±1% air entrainment for the entire length of the headwalls. The headwalls shall be installed on an inward batter to be not less than 1 horizontal to 5 vertical, and under no circumstances shall this batter, which is measured from the top of the headwall to the projection of the end of the pipe, be less than 305mm (12"). From the midpoint of the pipe height down to the concrete footing, the wall shall be a double concrete filled jute bag installation. On the road side the walls shall be deflected as shown to provide daylighting and a better approach across the new bridge.

The installation of the concrete filled jute bag headwalls, unless otherwise specified, shall be provided in total compliance with the Items 1, 3, and 4 included in the **"STANDARD SPECIFICATIONS FOR ACCESS BRIDGE CONSTRUCTION"**. These are attached to the back of these specifications and labelled **Appendix "REI-C"**. The Contractor shall comply in all respects with the General Conditions included in Item 4 and the **"Typical Concrete Filled Jute Bag Headwall End Protection"** detail also shown therein.

The Contractor shall install interlocking precast concrete blocks with filter cloth backing for walls on both ends of the bridges requiring same. The blocks shall be minimum 600X600X1200mm in size as available from Underground Specialties - Wolseley, Windsor, Ontario, or equal, and installed as set out in **Appendix "REI-C"**. Vertical joints shall be staggered by use of half blocks where needed and wingwall deflections when required shall employ 45-degree angled blocks. Voids between the blocks and the pipe shall be grouted with 30MPa concrete having 6% ±1% air entrainment and extend for the full thickness of the wall and have a smooth uniform finish on the face that blends with the precast blocks. The installation of the endwalls, as well as the backfilling of the pipe where applicable, shall be provided in compliance with Items 1), 3), and 4) of the **"Standard Specifications for Access Bridge Construction"** attached within **Appendix "REI-C"** and in total compliance and in all respects with the General Conditions included in said Appendix. The Contractor shall submit shop drawings for approval of the wall installation that includes details for a minimum 300mm thick concrete footing that extends from the pipe invert downward. The footing shall extend into the drain banks each side for the required embedment of the blocks and be constructed to ensure that the completed wall will be completely vertical or tipped slightly back towards the driveway. Where the block walls extend more than 1.8 metres in height, the supplier shall provide the Contractor with uni-axial geogrid (SG350 or equivalent) reinforcement for installation to tie the wall back into the granular backfill. The Contractor, in all cases, shall comply with these specifications and upon completion of the stacked precast concrete end protection installation shall restore the adjacent areas to their original conditions. The Contractor shall supply quarried limestone on filter cloth rock protection adjacent to the headwalls at each corner of the bridge. All rock protection shall be 1.0 metres wide and 305mm (12") thick, installed on non-woven filter cloth, and shall be installed in accordance with Item 2) of the **"Standard Specifications for Access Bridge Construction"**. The synthetic filter mat to be used shall be non-woven geotextile GMN160 conforming to O.P.S.S. 1860 Class I, as available from Armtec Construction Products through Underground Specialties - Wolseley in Windsor, Ontario or equal. The quarried limestone to be used shall be graded in size from a minimum of 100mm to a maximum of 250mm, and is available from Walker Industries Amherst Quarries, in Amherstburg, Ontario, or equal.

Where sloped end protection is specified, the top 305mm (12”) of backfill material over the ends of the access pipe, from the invert of said pipe to the top of the driveway elevation of the access bridge or enclosure, shall be quarried limestone. The quarried limestone shall be provided as shown and detailed on the plans or as indicated in the Standard Specifications in **Appendix “REI-C”** and shall be graded in size from a minimum of 100mm (4”) to a maximum of 250mm (10”). The quarried limestone to be placed on the sloped ends of an access bridge or enclosure shall be underlain with a synthetic non-woven geotextile filter fabric. The sloped quarried limestone protection is to be rounded as shown on the plan details and shall also extend along the drain side slopes to a point directly in line with the ends of the culvert pipe. The road side approach to the entrance shall be provided with a minimum 5.0m radius at each end of the driveway entrance. All work shall be completed to the full satisfaction of the Town Drainage Superintendent or the Consulting Engineer.

The installation of the sloped quarried limestone end protection, unless otherwise specified herein, shall be provided in total compliance with Item 2), 3), and 4) of the **“STANDARD SPECIFICATIONS FOR ACCESS BRIDGE CONSTRUCTION”**. These are attached to the back of these specifications and labelled **Appendix “REI-C”**. The Contractor shall comply in all respects with the General Conditions included in Item 4 and the **“Typical Quarried Limestone End Protection Detail”** also in **Appendix “REI-C”**.

The quarried limestone erosion protection shall be embedded into the sideslopes of the drain a minimum thickness of 305mm and shall be underlain in all cases with non-woven synthetic filter mat. The filter mat shall not only be laid along the flat portion of the erosion protection, but also contoured to the exterior limits of the quarried limestone and the unprotected slope. The width of the erosion protection shall be as established in the accompanying drawings or as otherwise directed by the Town Drainage Superintendent or the Consulting Engineer during construction. In placing the erosion protection, the Contractor shall carefully tamp the quarried limestone pieces into place with the use of the excavator bucket so that the erosion protection when completed will be consistent, uniform and tightly laid. In no instance shall the quarried limestone protrude beyond the exterior contour of the unprotected drain sideslopes along either side of said protection. The synthetic filter mat fabric to be used shall be non-woven geotextile GMN160 conforming to O.P.S.S. 1860 Class I, as available from Armtec Construction Products, or equal. The quarried limestone to be used shall be graded in size from a minimum of 100mm to a maximum of 250mm, and is available from Walker Aggregates Amherst Quarries, in Amherstburg, Ontario, or equal.

XII. GENERAL QUARRIED LIMESTONE EROSION PROTECTION

At all of the swale and furrow locations entering the drain from the either side, it is required that general quarried limestone erosion protection and rock chutes be provided on the drain slopes, at the locations indicated or established due to erosion, and to the widths generally shown within the details and notes included in the accompanying drawings. The rock chutes shall be v-shaped and constructed to direct all flows through the centre portion of the rock chute. Where the drain banks are showing erosion or slumping and distress, the Contractor shall provide quarried limestone on filter cloth general erosion protection as outlined below. Protection locations shall be as established in consultation with the Town Drainage Superintendent and Consulting Engineer and shall include the areas noted on the profiles.

The quarried limestone erosion protection shall be embedded into the sideslopes of the drain a minimum thickness of 305mm and shall be underlain in all cases with non-woven synthetic filter mat. The filter mat shall not only be laid along the flat portion of the erosion protection, but also contoured to the exterior limits of the quarried limestone and the unprotected slope. The width of the general erosion protection shall be as established in the accompanying drawings or as otherwise directed by the Town Drainage Superintendent or the Consulting Engineer during construction. In placing the erosion protection, the Contractor shall carefully tamp the quarried limestone pieces into place with the use of the equipment bucket so that the erosion protection when completed will be consistent, uniform and tightly laid. In no instance shall the quarried

limestone protrude beyond the exterior contour of the unprotected drain sideslopes along either side of said protection. The synthetic filter mat to be used shall be non-woven geotextile GMN160 conforming to O.P.S.S. 1860 Class I, as available from Armtec Construction Products, or equal. The quarried limestone to be used shall be graded in size from a minimum of 100mm to a maximum of 250mm, and is available from Walker Aggregates Amherst Quarries, in Amherstburg, Ontario, or equal.

XIII. BENCHMARKS

Also, for use by the Contractor, we have established Benchmarks along the course of the work and especially at the location where the existing bridges are located. The Contractor shall work with the Drainage Superintendent or Inspector to transfer the benchmark from any object being removed to a temporary site benchmark such as a nail in a tree or top of a tile that is not being disturbed. This temporary site benchmark is to be used in setting the drain design grades.

For the bridge removals, the plans include details illustrating the work to be carried out. For each bridge detail a Benchmark has been indicated and the elevation has been shown and may be utilized by the Contractor in carrying out its work. In all cases, the Contractor is to utilize the specified drain grade to control its work. The Contractor shall ensure that it takes note of the direction of flow and sets all grades to assure that all flows go from south to north to match the direction of flow within the drain.

XIV. ANCILLARY WORK

During the course of any work to the bridges along the course of the work, the Contractor will be required to protect or extend any existing tile ends or swales and connect them to the drainage works to maintain the drainage from the adjacent lands. All existing tiles shall be extended utilizing solid Big 'O' "standard tile ends" or equal plastic pipe of the same diameter as the existing tile and shall be installed in accordance with the "**Standard Lateral Tile Detail**" included in the plans, unless otherwise noted. Connections shall be made using a manufactured coupling where possible. For other connections, the Contractor shall utilize a grouted connection. Grouted mortar joints shall be composed of three (3) parts of clean, sharp sand to one (1) part of Portland cement with just sufficient water added to provide a stiff plastic mix, and the mortar connection shall be performed to the full satisfaction of the Town Drainage Superintendent or the Consulting Engineer. The mortar joint shall be of a sufficient mass around the full circumference of the joint on the exterior side to ensure a tight, solid seal. The Contractor is to note that any intercepted pipes along the length of the existing culverts are to be extended and connected to the open drain unless otherwise noted in the accompanying drawings.

The Contractor shall re-grade the existing swales to allow for the surface flows to freely enter the drain. Any disturbed grass areas shall be fully restored with topsoil, seed and mulch.

Although it is anticipated that the bridge removal at each site shall be undertaken in the dry, the Contractor shall supply and install a temporary straw bale check dam in the drain bottom immediately downstream of each bridge site during the time of construction. The straw bale check dam shall be to the satisfaction of the Town Drainage Superintendent or Consulting Engineer and must be removed upon completion of the construction. The straw bales may be reused at each site subject to their condition. All costs associated with the supply and installation of this straw bale check dam shall be included in the cost bid for the bridge removal.

XV. TOPSOIL, SEED AND MULCH

The Contractor will be required to protect grass buffers and driveway accesses along the top of the drain bank where they currently exist. Where any of these are damaged, they shall be fully restored including placement of topsoil. The topsoil shall be prepared for seeding as noted

further in these specifications. Should the existing topsoil be treated to prevent grass growth, the Contractor shall strip the existing topsoil material back and spread it on the adjacent field and supply 50mm thick imported topsoil, or topsoil material scavenged from the drain banks at rock protection locations, that is suitable for growing grass.

The Contractor shall be required to restore all existing grassed areas and drain side slopes damaged by the construction and cutting of the drain cross-section by placing topsoil, and then seed and mulch over said areas including any specific areas noted on the bridge details. The Contractor shall be required to provide all the material and to cover the above mentioned surfaces with approximately 50mm of good, clean, dry topsoil on slopes and 100mm of good, clean, dry topsoil on horizontal surfaces, fine graded and spread in place ready for seeding and mulching. The placing and grading of all topsoil shall be carefully carried out according to Ontario Provincial Standard Specifications, Form 570, dated November 2007, or as subsequently amended or as amended by these Specifications. Once the topsoil has been properly placed and fine graded, the Contractor shall seed and mulch the area. Seeding and mulching operations shall be carried out in accordance with Ontario Provincial Standard Specifications, Form 572, dated November 2003, or as subsequently amended or as amended by these Specifications. The seeding mixture shall be OSECO Lawn Seed Mixture Canada No. 1 or equal as available from Morse Growers Supply, Leamington or equal. As part of the seeding and mulching operation, the Contractor will be required to provide either a hydraulic mulch mix or straw mulch with adhesive binder in accordance with O.P.S.S. 1103.05.03 dated November 2007, or as subsequently amended, to ensure that the grass seed will be protected during germination and provide a thick, uniform cover to minimize erosion, where necessary. All work shall be completed to the full satisfaction of the Town Drainage Superintendent and the Consulting Engineer.

All of the work relative to the placement of topsoil and the seeding and mulching operation shall be meticulously done and completed in a good and workmanlike manner all to the full satisfaction of the Town Drainage Superintendent and Consulting Engineer.

XVI. GENERAL CONDITIONS

- a) The Town Drainage Superintendent or Consulting Engineer shall have authority to carry out minor changes to the work where such changes do not lessen the efficiency of the work.
- b) The Contractor shall satisfy itself as to the exact location, nature and extent of any existing structure, utility, or other object which it may encounter during the course of the work. The Contractor shall indemnify and save harmless the Town of Tecumseh and the Consulting Engineer and their representatives for any damages which it may cause or sustain during the progress of the work. It shall not hold the Town of Tecumseh or the Consulting Engineer liable for any legal action arising out of any claims brought about by such damage caused by it.
- c) The Contractor shall provide a sufficient number of layout stakes and grade points so that the Drainage Superintendent and Consulting Engineer can review same and check that the work will generally conform to the design and project intent.
- d) The Contractor will be responsible for any damage caused by it to any portion of the Town road system, especially to the travelled portion. When excavation work is being carried out and the excavation equipment is placed on the travelled portion of the road, the travelled portion shall be protected by having the excavation equipment placed on satisfactory timber planks or timber pads. If any part of the travelled portion of the road is damaged by the Contractor, the Town shall have the right to have the necessary repair work done by its' employees and the cost of all labour and materials used to carry out the repair work shall be deducted from the Contractor's contract and credited to the Town. The Contractor, upon completing the works, shall clean all debris and junk, etcetera, from the roadside of the drain, and leave the site in a neat and workmanlike manner. The Contractor shall be

responsible for keeping all public roadways utilized for hauling materials free and clear of mud and debris.

- e) The Contractor shall provide all necessary lights, signs, and barricades to protect the public. All work shall be carried out in accordance with the requirements of the Occupational Health and Safety Act, and latest amendments thereto. If traffic control is required on this project, signing is to comply with the M.T.O. Manual of Uniform Traffic Control Devices (M.U.T.C.D.) for Roadway Work Operations and Ontario Traffic Manual Book 7.
- f) During the course of the work the Contractor shall be required to connect existing drainage pipes to the Municipal Drain. In the event that polluted flows are discovered, the Contractor shall delay the connection of the pipe and leave the end exposed and alert the Town, the Drainage Superintendent, and the Consulting Engineer so that steps can be taken by the Town to address the concern with the owner and the appropriate authorities. Where necessary the Contractor shall cooperate with the Town in providing temporary measures to divert the drain or safely barricade same. Should the connection be found acceptable by the authorities, the Contractor shall complete the connection of the drain as provided for in the specifications, at no extra cost to the project.
- g) Following the completion of the work, the Contractor is to trim up any broken or damaged limbs on trees which are to remain standing, and it shall dispose of said branches along with other brush, thus leaving the trees in a neat and tidy condition.
- h) The whole of the work shall be satisfactorily cleaned up, and during the course of the construction, no work shall be left in any untidy or incomplete state before subsequent portions are undertaken.
- i) During the course of the project the Contractor shall deal with any excess soil management from the project in accordance with Ontario Reg 406/19 pursuant to the Environmental Protection Act, R.S.O. 1990, c. E.19 and any subsequent amendments to same.
- j) All driveways, laneways and access bridges, or any other means of access on to the job site shall be fully restored to their former condition at the Contractor's expense. Before authorizing Final Payment, the Town Drainage Superintendent and the Consulting Engineer shall inspect the work in order to be sure that the proper restoration has been performed. In the event that the Contractor fails to satisfactorily clean up any portion of these accesses, the Consulting Engineer shall order such cleanup to be carried out by others and the cost of same be deducted from any monies owing to the Contractor.
- k) The Contractor will be required to submit to the Town, a Certificate of Good Standing from the Workplace Safety and Insurance Board prior to the commencement of the work and the Contractor will be required to submit to the Town, a Certificate of Clearance for the project from the Workplace Safety and Insurance Board before Final Payment is made to the Contractor.
- l) The Contractor shall furnish a Performance and Maintenance Bond along with a separate Labour and Material Payment Bond within ten (10) days after notification of the execution of the Agreement by the Town. One copy of said bonds shall be bound into each of the executed sets of the Contract. Each Performance and Maintenance Bond and Labour and Material Payment Bond shall be in the amount of 100% of the total Tender Price. All Bonds shall be executed under corporate seal by the Contractor and a surety company, authorized by law to carry out business in the Province of Ontario. The Bonds shall be acceptable to the Town in every way and shall guarantee faithful performance of the contract during the period of the contract, including the period of guaranteed maintenance which will be in effect for twelve (12) months after substantial completion of the works.

The Tenderer shall include the cost of bonds in the unit price of the Tender items as no additional payment will be made in this regard.

- m) The Contractor shall be required, as part of this Contract, to provide Comprehensive Liability Insurance coverage for not less than \$5,000,000.00 on this project; and shall name the Town of Tecumseh and its' officials and the Consulting Engineer and their staff as additional insured under the policy. The Contractor must submit a copy of this policy to both the Town Clerk and the Consulting Engineer prior to the commencement of work.
- n) Monthly progress orders for payment shall be furnished the Contractor by the Town Drainage Superintendent. Said orders shall be for not more than 90% of the value of the work done and the materials furnished on the site. The paying of the full 90% does not imply that any portion of the work has been accepted. The remaining 10% will be paid 60 days after the final acceptance and completion of the work and payment shall not be authorized until the Contractor provides the following:
 - i) a Certificate of Clearance for the project from the Workplace Safety and Insurance Board
 - ii) proof of advertising

The Contractor shall satisfy the Consulting Engineer or Town that there are no liens or claims against the work and that all of the requirements as per the Construction Act, 2018 and its' subsequent amendments have been adhered to by the Contractor.
- o) In the event that the Specifications, Information to Tenderers, or the Form of Agreement do not apply to a specific condition or circumstance with respect to this project, the applicable section, or sections from the Canadian Construction Documents Committee C.C.D.C.2 shall govern and be used to establish the requirements of the work.
- p) Should extra work be required by the Town Drainage Superintendent or Consulting Engineer, and it is done on a time and material basis, the actual cost of the work will be paid to the Contractor with a 15% markup on the total actual cost of labour, equipment and materials needed to complete the extra work.

APPENDIX “REI-A”

STANDARD E.R.C.A. AND D.F.O.
MITIGATION REQUIREMENTS

As part of its work, the Contractor will implement the following measures that will ensure that any potential adverse effects on fish and fish habitat will be mitigated:

1. As per standard requirements, work will not be conducted at times when flows in the drain are elevated due to local rain events, storms, or seasonal floods. Work will be done in the dry.
2. All disturbed soils on the drain banks and within the channel, including spoil, must be stabilized immediately upon completion of work. The restoration of the site must be completed to a like or better condition to what existed prior to the works. The spoil material must be hauled away and disposed of at a suitable site, or spread an appropriate distance from the top of the drain bank to ensure that it is not washed back into the drain.
3. To prevent sediment entry into the drain in the event of an unexpected rainfall, silt barriers and/or traps must be placed in the channel during the works and until the site has been stabilized. All sediment and erosion control measures are to be in accordance with the related Ontario Provincial Standards. It is incumbent on the proponent and Contractors to ensure that sediment and erosion control measures are functioning properly and maintained/upgraded as required.
4. Silt or sand accumulated in the barrier traps must be removed and stabilized on land once the site is stabilized.
5. All activities including maintenance procedures should be controlled to prevent the entry of petroleum products, debris, rubble, concrete, or other deleterious substances into the water. Vehicular refuelling and maintenance should be conducted away from the water.
6. Any drain banks trimmed outside of the July 1st to September 15th timing window will require bio-degradable erosion control blankets to be installed to promote re-vegetation and to protect the slope from erosion in the interim.

Measures to Avoid Causing Harm to Fish and Fish Habitat

If you are conducting a project near water, it is your responsibility to ensure you avoid causing [serious harm to fish](#) in compliance with the *Fisheries Act*. The following advice will help you avoid causing harm and comply with the *Act*.

PLEASE NOTE: This advice applies to all project types and replaces all “Operational Statements” previously produced by DFO for different project types in all regions.

Measures

- Time work in water to respect [timing windows](#) to protect fish, including their eggs, juveniles, spawning adults and/or the organisms upon which they feed.
- Minimize duration of in-water work.
- Conduct instream work during periods of low flow, or at low tide, to further reduce the risk to fish and their habitat or to allow work in water to be isolated from flows.
- Schedule work to avoid wet, windy and rainy periods that may increase erosion and sedimentation.

- Design and plan activities and works in waterbody such that loss or disturbance to aquatic habitat is minimized and sensitive spawning habitats are avoided.
- Design and construct approaches to the waterbody such that they are perpendicular to the watercourse to minimize loss or disturbance to riparian vegetation.
- Avoid building structures on meander bends, braided streams, alluvial fans, active floodplains or any other area that is inherently unstable and may result in erosion and scouring of the stream bed or the built structures.
- Undertake all instream activities in isolation of open or flowing water to maintain the natural flow of water downstream and avoid introducing sediment into the watercourse.

- Plan activities near water such that materials such as paint, primers, blasting abrasives, rust solvents, degreasers, grout, or other chemicals do not enter the watercourse.
- Develop a response plan that is to be implemented immediately in the event of a sediment release or spill of a deleterious substance and keep an emergency spill kit on site.
- Ensure that building material used in a watercourse has been handled and treated in a manner to prevent the release or leaching of substances into the water that may be deleterious to fish.

- Develop and implement an Erosion and Sediment Control Plan for the site that minimizes risk of sedimentation of the waterbody during all phases of the project. Erosion and sediment control measures should be maintained until all disturbed ground has been permanently stabilized, suspended sediment has resettled to the bed of the waterbody or settling basin and runoff water is clear. The plan should, where applicable, include:
 - Installation of effective erosion and sediment control measures before starting work to prevent sediment from entering the water body.
 - Measures for managing water flowing onto the site, as well as water being pumped/diverted from the site such that sediment is filtered out prior to the water entering a waterbody. For example, pumping/diversion of water to a vegetated area, construction of a settling basin or other filtration system.
 - Site isolation measures (e.g., silt boom or silt curtain) for containing suspended sediment where in-water work is required (e.g., dredging, underwater cable installation).
 - Measures for containing and stabilizing waste material (e.g., dredging spoils, construction waste and materials, commercial logging waste, uprooted or cut aquatic plants, accumulated debris) above the high water mark of nearby waterbodies to prevent re-entry.
 - Regular inspection and maintenance of erosion and sediment control measures and structures during the course of construction.
 - Repairs to erosion and sediment control measures and structures if damage occurs.
 - Removal of non-biodegradable erosion and sediment control materials once site is stabilized.
- Clearing of riparian vegetation should be kept to a minimum: use existing trails, roads or cut lines wherever possible to avoid disturbance to the riparian vegetation and prevent soil compaction. When practicable, prune or top the vegetation instead of grubbing/uprooting.
- Minimize the removal of natural woody debris, rocks, sand or other materials from the banks, the shoreline or the bed of the waterbody below the ordinary high water mark. If material is removed from the waterbody, set it aside and return it to the original location once construction activities are completed.
- Immediately stabilize shoreline or banks disturbed by any activity associated with the project to prevent erosion and/or sedimentation, preferably through re-vegetation with native species suitable for the site.
- Restore bed and banks of the waterbody to their original contour and gradient; if the original gradient cannot be restored due to instability, a stable gradient that does not obstruct fish passage should be restored.
- If replacement rock reinforcement/armouring is required to stabilize eroding or exposed areas, then ensure that appropriately-sized, clean rock is used; and that rock is installed at a similar slope to maintain a uniform bank/shoreline and natural stream/shoreline alignment.
- Remove all construction materials from site upon project completion.

- Ensure that all in-water activities, or associated in-water structures, do not interfere with fish passage, constrict the channel width, or reduce flows.
- Retain a qualified environmental professional to ensure applicable permits for relocating fish are obtained and to capture any fish trapped within an isolated/enclosed area at the work site and safely relocate them to an appropriate location in the same waters. Fish may need to be relocated again, should flooding occur on the site.
- Screen any water intakes or outlet pipes to prevent entrainment or impingement of fish. Entrainment occurs when a fish is drawn into a water intake and cannot escape. Impingement occurs when an entrapped fish is held in contact with the intake screen and is unable to free itself.
 - In freshwater, follow these measures for design and installation of intake end of pipe fish screens to protect fish where water is extracted from fish-bearing waters:
 - Screens should be located in areas and depths of water with low concentrations of fish throughout the year.
 - Screens should be located away from natural or artificial structures that may attract fish that are migrating, spawning, or in rearing habitat.
 - The screen face should be oriented in the same direction as the flow.
 - Ensure openings in the guides and seals are less than the opening criteria to make “fish tight”.
 - Screens should be located a minimum of 300 mm (12 in.) above the bottom of the watercourse to prevent entrainment of sediment and aquatic organisms associated with the bottom area.
 - Structural support should be provided to the screen panels to prevent sagging and collapse of the screen.
 - Large cylindrical and box-type screens should have a manifold installed in them to ensure even water velocity distribution across the screen surface. The ends of the structure should be made out of solid materials and the end of the manifold capped.
 - Heavier cages or trash racks can be fabricated out of bar or grating to protect the finer fish screen, especially where there is debris loading (woody material, leaves, algae mats, etc.). A 150 mm (6 in.) spacing between bars is typical.
 - Provision should be made for the removal, inspection, and cleaning of screens.
 - Ensure regular maintenance and repair of cleaning apparatus, seals, and screens is carried out to prevent debris-fouling and impingement of fish.
 - Pumps should be shut down when fish screens are removed for inspection and cleaning.
- Avoid using explosives in or near water. Use of explosives in or near water produces shock waves that can damage a fish swim bladder and rupture internal organs. Blasting vibrations may also kill or damage fish eggs or larvae.
 - If explosives are required as part of a project (e.g., removal of structures such as piers, pilings, footings; removal of obstructions such as beaver dams; or preparation of a river or lake bottom for installation of a structure such as a dam or water intake), the potential for impacts to fish and fish habitat should be minimized by implementing the following measures:

- Time in-water work requiring the use of explosives to prevent disruption of vulnerable fish life stages, including eggs and larvae, by adhering to appropriate fisheries [timing windows](#).
- Isolate the work site to exclude fish from within the blast area by using bubble/air curtains (i.e., a column of bubbled water extending from the substrate to the water surface as generated by forcing large volumes of air through a perforated pipe/hose), cofferdams or aquadams.
- Remove any fish trapped within the isolated area and release unharmed beyond the blast area prior to initiating blasting
- Minimize blast charge weights used and subdivide each charge into a series of smaller charges in blast holes (i.e., decking) with a minimum 25 millisecond (1/1000 seconds) delay between charge detonations (see Figure 1).
- Back-fill blast holes (stemmed) with sand or gravel to grade or to streambed/water interface to confine the blast.
- Place blasting mats over top of holes to minimize scattering of blast debris around the area.
- Do not use ammonium nitrate based explosives in or near water due to the production of toxic by-products.
- Remove all blasting debris and other associated equipment/products from the blast area.

Figure 1: Sample Blasting Arrangement

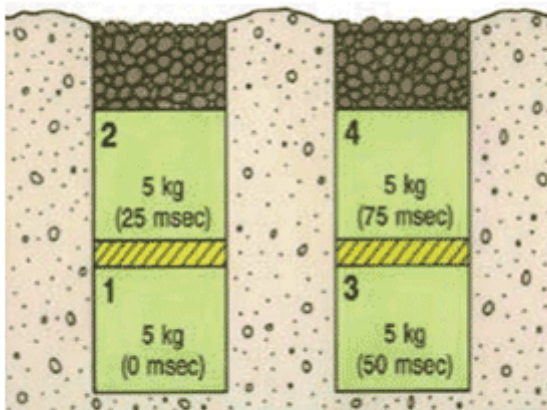

Per Fig. 1: 20 kg total weight of charge; 25 msecs delay between charges and blast holes; and decking of charges within holes.

- Ensure that machinery arrives on site in a clean condition and is maintained free of fluid leaks, invasive species and noxious weeds.

- Whenever possible, operate machinery on land above the high water mark, on ice, or from a floating barge in a manner that minimizes disturbance to the banks and bed of the waterbody.
- Limit machinery fording of the watercourse to a one-time event (i.e., over and back), and only if no alternative crossing method is available. If repeated crossings of the watercourse are required, construct a temporary crossing structure.
- Use temporary crossing structures or other practices to cross streams or waterbodies with steep and highly erodible (e.g., dominated by organic materials and silts) banks and beds. For fording equipment without a temporary crossing structure, use stream bank and bed protection methods (e.g., swamp mats, pads) if minor rutting is likely to occur during fording.
- Wash, refuel and service machinery and store fuel and other materials for the machinery in such a way as to prevent any deleterious substances from entering the water.

Date modified:
2013-11-25

APPENDIX “REI-B”

5.0 Location

Located along the southern shores of Lake St. Clair in Essex County and in the Essex Region Watershed, the Town of Tecumseh (Study Area) encompasses a geographic area of 9,538.60 hectares (ha) that is bordered by the City of Windsor and the Town of LaSalle on its western side and the Town of Lakeshore to the east and shown on **Figure 1** (Essex Region Conservation Authority (ERCA), 2013). There are four (4) subwatersheds (total area): Pike Creek subwatershed (8,993 ha), Canard River subwatershed (34,776 ha), Tecumseh Area Drainage subwatershed (1,150 ha), Turkey Creek subwatershed (6,112 ha), and Little River subwatershed (6,490 ha) that traverse the lands within the Town's boundaries (ERCA, 2011). Approximately 95.15% (9,079.38 ha) of the landscape consists of anthropogenic features (residential, commercial, agricultural, etc.) while the remaining 4.81% (459.22 ha) is made up of natural areas (terrestrial (4.49%) and other terrestrial (0.32%)) (ERCA, 2013).

There are one hundred and twenty (120) municipal drains measuring 221 kilometers (km) within the Town of Tecumseh (Town of Tecumseh, 2014). Through our background review we identified 3 dominant habitat types surrounding/within the drains that have potential to provide habitat for SAR. Habitats consist of:

Existing Natural Features:

- Forest

Existing Anthropogenic Features:

- Urban (residential, commercial, recreational, right-of-ways)
- Agricultural (row crop, hayfield, old abandoned fields)

Within the Town, there are no forest patches greater than 100 ha in size with the largest being Fairplay Woods (an Environmentally Significant Area (ESA)) which spans a total area of 52.9 ha (ERCA, 2013). There are 2 forest patches that contain 200 m interior forest and 16 patches that contain 100 m interior forest (ERCA, 2013). In accordance with subparagraph i, of paragraph 2, of subsection 6 under Section 23.9 of O.Reg. 242/08, **Drainage Maps** have been prepared that show drain locations, surrounding land use types, proximity to sensitive natural features (e.g. Forest) and potential SAR habitat that exists within the Town's jurisdiction (see **Appendix B**). A list of all the drains and adjacent habitat type(s) has been provided in **Appendix B** following the Drainage Maps. In addition, a **Tecumseh Drain Database** (provided electronically) contains the drain names, adjacent habitat types, and relevant information found during our background review from the MNRF and ERCA.



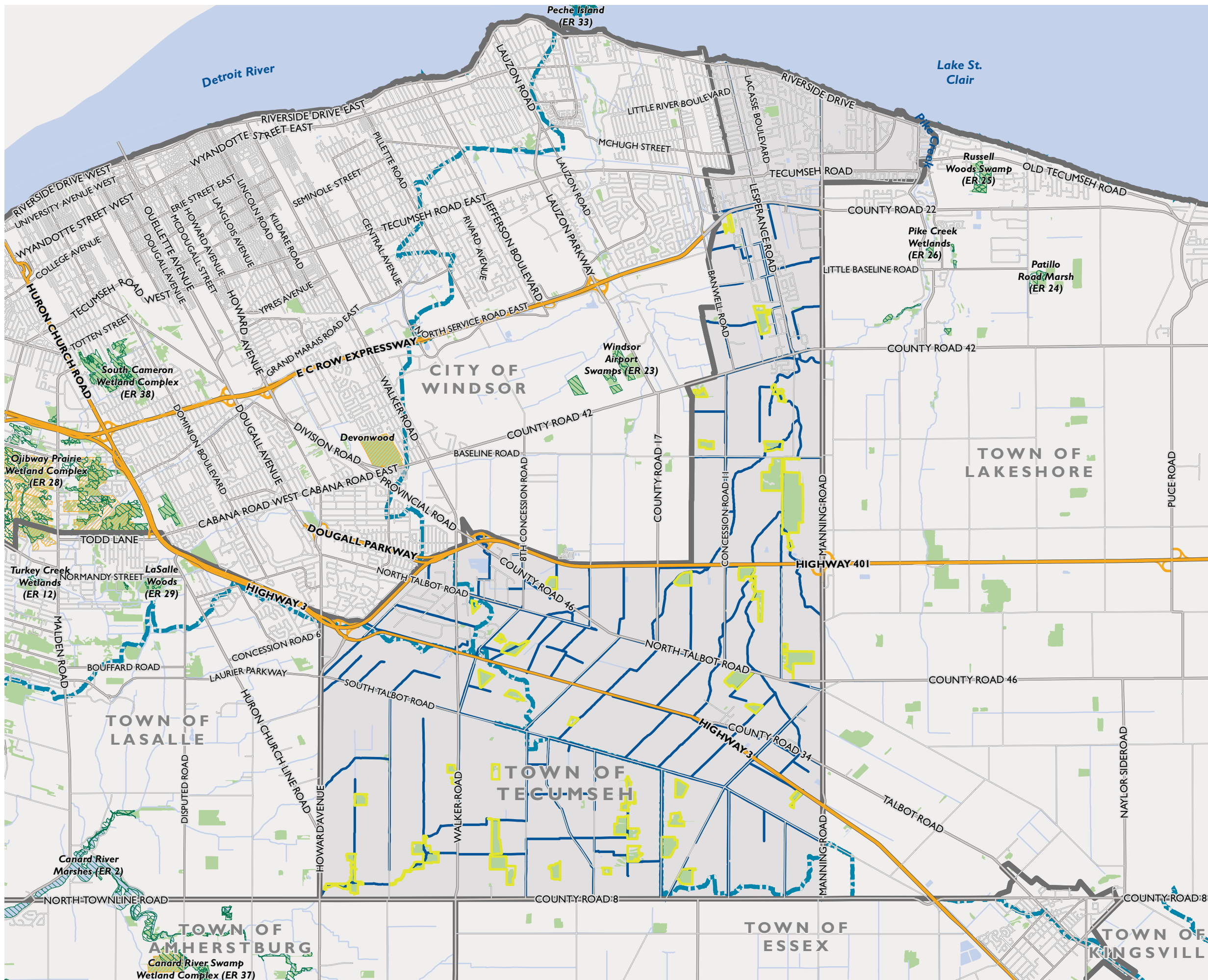

TOWN OF TECUMSEH

NATURAL FEATURES

FIGURE 1

- Mainland
- Provincially Significant Wetland
- ANSI, Life Science
- Natural Heritage System
- Municipal Drain
- Quaternary Watershed
- Water Body
- Woodland

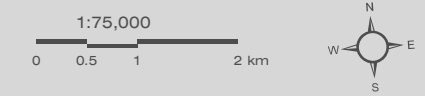

MAP DRAWING INFORMATION:
DATA PROVIDED BY MNR, TOWN OF TECUMSEH

MAP CREATED BY: GM
MAP CHECKED BY: KM/AB
MAP PROJECTION: NAD 1983 UTM Zone 17N



PROJECT: 174938
STATUS: FINAL
DATE: 2017-12-08

6.0 Species at Risk

A review of secondary source information, including the expired MNRF Agreement¹, Natural Heritage Information Centre (NHIC) GIS Database records (i.e. 1 km squares that overlap the Study Area) were reviewed to gather a list of the SAR that have the potential to occur within the Town's boundaries. A total of sixty-six (66) species listed as either endangered or threatened on the SARO list (O.Reg. 230/08) were identified to occur within the Study Area (see **Appendix C**). One Restricted Species Record was also identified in 1988 (NHIC 1 km Square 17LG4478).

The habitat requirements for each of the sixty-six species was cross referenced with habitats identified within the Study Area. A total of Nineteen (19) species listed as endangered or threatened were identified as having potential habitat within the Study Area drains, consisting of Turtles (2 species), Snakes (2 species), Fishes (2 species), Birds (3 species), and Plants (10 species). **Table 2** lists the SAR, preferred habitat type(s) (Forest, Agricultural, Urban or All), need for water presence (requirement for some species), and the dates during the year when the species is likely to be carrying out sensitive life processes, referred to herein as the Restricted Activity Period (RAP).

Four (4) species listed in Table 1, subsection 2, Section 23.9 of O. Reg. 242/08 were identified as having the potential to occur within the Town of Tecumseh drains, these species include: Pugnose Minnow (*Opsopoeodus emiliae*) (1 fish species), False Hop Sedge (*Carex lupuliformis*), Heart-leaved Plantain (*Plantago cordata*) and Scarlet Ammannia (*Ammannia robusta*) (3 plant species). Since these species are listed in Table 1, subsection 2, Section 23.9 of O. Reg. 242/08, this mitigation plan cannot be used for these species and as such, they have not been included in **Table 2** below. Permitting related to these species may be required when working in specific drains. More information on these species, their habitat preferences, known distribution within the area and steps that need to be taken to determine whether a permit is required are outlined in **Appendix D**.

Table 2: Species at Risk with Potential to Occur within the Study Area

Scientific Name	Common Name	ESA ¹	Preferred Habitat Type ²	Restricted Activity Period
Turtles (2 species)				
<i>Emydoidea blandingii</i>	Blanding's Turtle	THR	Forest, Water is present	November 1 to April 30 Important to Note: Activities that require water level reduction cannot occur in areas when and where turtles are hibernating (paragraph 6, subsection 13, under Section 23.9 of O.Reg. 242/08).
<i>Apalone spinifera</i>	Spiny Softshell	THR	Forest, Water is present	

¹ Agreement under Section 23 of O.Reg. 242/08 made under the ESA, 2007 (File # AY-23D-010-10)



Scientific Name	Common Name	ESA ¹	Preferred Habitat Type ²	Restricted Activity Period
Snakes (2 species)				
<i>Pantherophis gloydi</i>	Eastern Foxsnake (Carolinian population)	END	All ³	September 20 to May 31
<i>Thamnophis butleri</i>	Butler's Gartersnake	END	All ³	
Fishes (2 species)				
<i>Notropis anogenus</i>	Pugnose Shiner	END	Water is present	March 15 to June 30
<i>Lepisosteus oculatus</i>	Spotted Gar	THR		
Birds (3 species)				
<i>Dolichonyx oryzivorus</i>	Bobolink	THR	Agricultural	May 1 to July 15
<i>Sturnella magna</i>	Eastern Meadowlark	THR	Agricultural	
<i>Hirundo rustica</i>	Barn Swallow	THR	All ³	
Vascular Plants (10 species)				
<i>Gymnocladus dioicus</i>	Kentucky Coffee-tree	THR	Forest	Not Applicable
<i>Liparis liliifolia</i>	Purple Twayblade	THR	Forest	
<i>Cornus florida</i>	Eastern Flowering Dogwood	END	Forest	
<i>Castanea dentata</i>	American Chestnut	END	Forest	
<i>Juglans cinerea</i>	Butternut	END	Forest	
<i>Morus rubra</i>	Red Mulberry	END	Forest	
<i>Aletris farinosa</i>	Colicroot	THR	Agricultural, Forest	
<i>Smilax rotundifolia</i>	Round-leaved Greenbrier (Great Lakes Plains population)	THR	Forest	
<i>Liatris spicata</i>	Dense Blazing Star	THR	Agricultural	
<i>Symphyotrichum praealtum</i>	Willowleaf Aster	THR	Forest	

¹Endangered Species Act – status as defined by O.Reg. 242/08 as of April 27, 2017; ²Preferred Habitat Types – The habitat types listed are areas where a SAR has the potential to occur. It should be noted that species have the potential to occur outside of these habitats; ³All – Structures such as culverts and bridges may provide suitable habitat for nesting Barn Swallow. Culverts, rip rap and gabion baskets also have the potential to provide nesting and/or hibernaculum for snake species.



7.0 Mitigation Measures

Based on the types of drainage work activities outlined above (in Section 2.0) and the potential for SAR and SAR habitat within and adjacent to the drainage features, the following best practices and mitigation measures are recommended when conducting drainage works. Prior to starting drainage works, the following steps are recommended to help determine the appropriate mitigation/management measures:

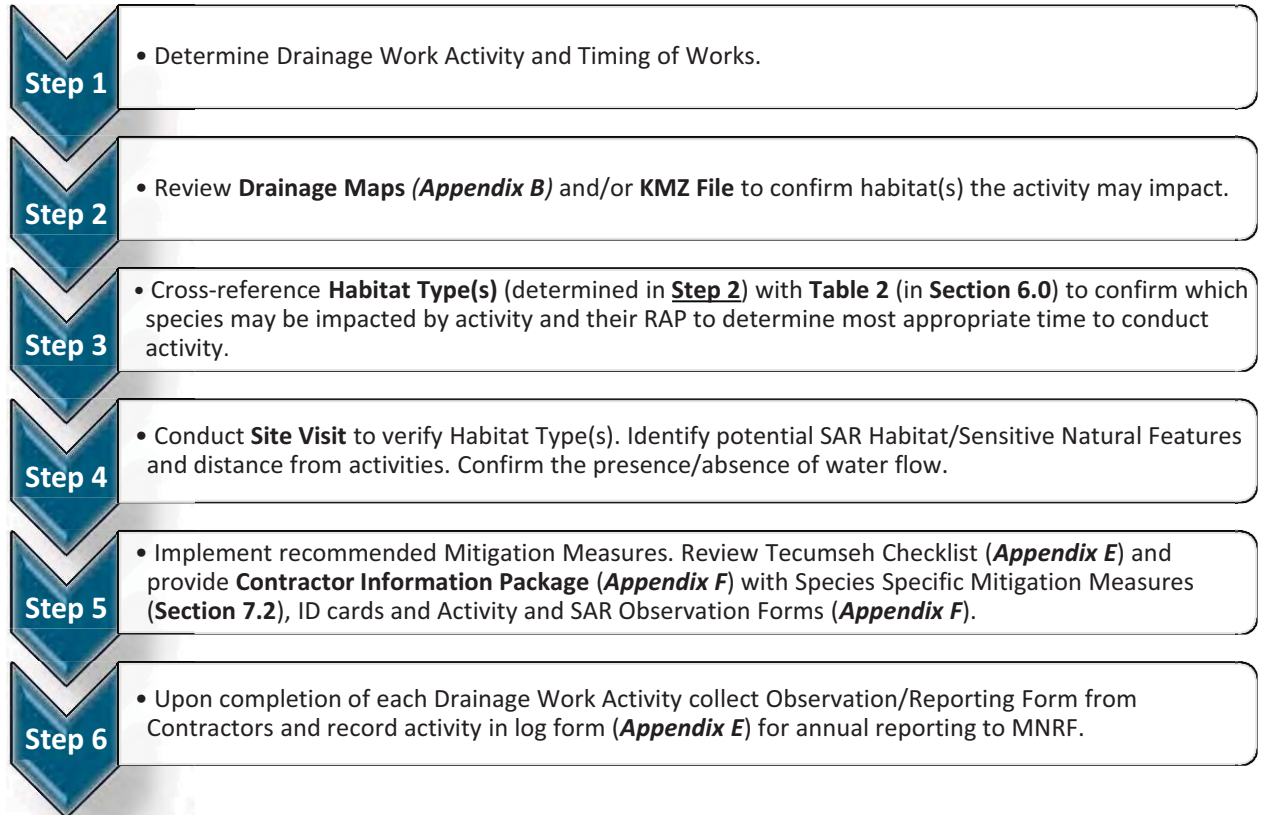

7.1 General Mitigation Measures

The following mitigation measures are recommended to avoid or minimize impacts to the natural environment when conducting drainage works. Following this section species specific mitigation measures are provided.

When planning for drainage works, activities should be planned outside of sensitive timing windows for all wildlife species wherever possible. **Table 2** in Section 6.0 indicates the Restricted Activity Periods for the different SAR having the potential to occur within the Study Area. **Table 3** indicates sensitive timing windows for various types of wildlife (including SAR) based on habitat types.

This information can be used to determine what time(s) of year may be sensitive at a particular site, based on which types of habitat and wildlife are present.

Where possible, activities are recommended to be planned outside of these sensitive time(s); otherwise additional species specific mitigation measures are recommended and/or consultation with the MNRF.

Table 3: Sensitive Timing Windows for other Wildlife Species (including SAR)

Habitat Type	Wildlife	Sensitive Timing Windows
Agricultural (Hayfields and pastures)	Migratory Birds	March through July (breeding season for most species)
Waterbodies	Migratory Birds (including waterfowl)	March through Mid-August
	Turtles and Amphibians	March through Mid-August; and Mid-October through March (for overwintering wildlife, including turtles).
	Mammals	March through mid-August; and Mid-October through March (overwintering wildlife)
	Fish	In-water timing restriction for warmwater fishes March 15 to June 30.
Forest	Migratory Birds	March through mid-August
	Mammals	March through mid-August; and Mid-October through March (overwintering wildlife)
	Snakes	March through mid-August; and Mid-October through March (overwintering wildlife)
Urban	Snakes	March through mid-August; and
	Mammals	October through March (overwintering wildlife)

The following list provides general measures that are recommended when conducting any drainage work activities:

- **Bats:** The work associated with drainage maintenance covered under this management plan would typically not include the removal of trees. As such, the potential for drainage work activities to impact bat SAR is low. However, if a tree that exhibits a diameter at breast height of 25 cm or greater or a tree that exhibits loose shaggy bark requires removal for drainage works, removal should be completed between November 1 and March 1, outside of the active season for bats. If the tree removal needs to occur during the active season, removal should be completed after dusk.
- Review species specific seasonal timing windows to avoid sensitive periods for species
- Where possible, abide by regulatory timing windows and setback distances and avoid regulated habitat features
- Minimize duration of in-water work (where applicable)



- Any in-stream work should be conducted during periods of low flow
- Schedule work to avoid wet, windy and rainy periods that may increase erosion and sedimentation
- Conduct wildlife sweeps prior to the commencement of drainage work activities to determine if SAR (or other wildlife) are present at the site and engaged in critical life processes (e.g. nesting, etc.)
- Following the wildlife sweep, the area of activity is to be isolated with silt fencing to keep SAR and other wildlife from entering the work space area.
- Develop and implement an erosion and sediment control plan for the site that minimizes the risk of sedimentation to the drain during all phases of an activity. Erosion and sediment control measures should be maintained until all disturbed ground has been permanently stabilized, suspended sediment has resettled to the bed of the drain of settling basin and runoff water is clear. Following the DFO's Measures to Avoid Harm (as outlined on DFO's website: <http://www.dfo-mpo.gc.ca/pnw-ppe/measures-mesures/measures-mesures-eng.html>), an erosion and sediment control plan, where applicable, is to include the following:
 - Installation of effective erosion and sediment control measures before starting work to prevent sediment from entering the drain
 - Measures for managing water flowing onto the site, as well as water being pumped/diverted from the site such that sediment is filtered out prior to the water entering the drain
 - Site isolation measures, where required, to contain suspended sediment
 - Measures for containing and stabilizing waste materials generated from activities are stored away from any water bodies and prevent materials from re-entering water bodies
 - Erosion and sediment control measures are inspected and maintained on a regular basis during drainage works
 - Any damages to erosion and control measures are to be repaired immediately
 - Removal of non-biodegradable erosion and sediment control materials once site has been stabilized
- ***Phragmites*** is a non-native perennial grass species that has been observed throughout much of the province and Tecumseh, developing tall dense stands that degrade wetlands and other features by outcompeting native vegetation and changing habitat. To further prevent the spread and introduction of this unwanted species in the province, the provincial government has regulated invasive *Phragmites* as restricted under the *Invasive Species Act*, 2015. Restricted species under the Act, prohibits i) the transport of species into any provincial park and conservation reserve and ii) the deposit or release of species in Ontario. For further information on the *Invasive Species Act*, 2015 please visit: www.ontario.ca/invasionON. It is recommended that care be taken when working in areas with *Phragmites* and efforts be taken to prevent further spread of species through equipment transfer. Methods to prevent the spread of *Phragmites* while conducting drainage works should include:
 - Inspection of vehicles, equipment and heavy machinery thoroughly inside and out for accumulation of dirt, plant material or snow/ice, including the underside of vehicles, radiators, spare tires, foot wells and bumpers before entering onto a site. Remove any guards, covers, plates or other easy to remove external equipment;



- Inspections should be completed when: moving vehicles out of local area of operation; moving machinery between properties or sites within the same property where invasive species may be present or known to occur; and using machinery along roadsides, in ditches and along watercourses.
- Vehicles, equipment and heavy machinery should be cleaned: before moving out of local area where invasive species has been identified or known to occur; and when accumulations of dirt, plant material or snow/ice has been observed.
- Clean vehicles, equipment and heavy machinery in an area where risk of contamination is low, ideally on a mud free hard surface, at least 30 m away from any watercourse, waterbody, wetland or other natural area, if possible. Where risk of runoff is high, cleaning stations should be contained by sediment fence as per standard erosion and sediment control specifications.
- Remove large accumulations of dirt, using a compressed air device, high pressure hose or other device as necessary. Clean the vehicle starting at the top and working down, with particular attention to the undersides, wheels, wheel arches, guards, chassis, engine bays, grills and other attachments.
- Clean inside vehicles by sweeping, vacuuming or using compressed air device including floor, foot wells, pedals, seats and under the seats.

Additional details on cleaning equipment and/or managing invasive species can be found in the Clean Equipment Protocol for Industry (J. Halloran, et al., 2013) and online at the Government of Ontario's website: <https://www.ontario.ca/page/stop-spread-invasive-species>.

7.2 Species Specific Mitigation Plans

In the event a SAR or SAR habitat has been identified within the proposed area for drainage work activity, the following information should be clearly conveyed to the on-site staff as part of the drainage works protocol, via notes or plans and on-site briefings with construction/personnel:

- Schedule for pre-construction activities such as wildlife inspections, silt fencing installation and contractor briefing.
- Description of wildlife mitigation measures to be used during drainage work activities, including:
 - Placement and specifications of required protection measures (e.g. fencing, signage)
 - Phasing and direction of site clearing activities
 - Any recommendations regarding access routes for equipment, vehicle parking, materials, stockpiling, etc.
- Guidance on what to do in the event of a wildlife encounter, including SAR and arrangements for dealing with injured or orphaned animals (as indicated in **Table 5** and **Appendix F**). This guidance should be summarized in a handout suitable for quick reference by on-site staff.
- SAR awareness training should be provided to all on-site staff, including truck drivers.

In the Contractor Information Package (**Appendix F**) Dillon has provided SAR identification sheets for SAR with the potential to occur within the Study Area.



Table 5: Mitigation Measures for Snake Species

Common Name	Recommended Mitigation Measures to Avoid Impacts to SAR Snakes in Study Area
Eastern Foxsnake (Carolinian population) and Butler's Gartersnake	<ul style="list-style-type: none"> • Preconstruction planning that includes review for potential habitat. • During site visit, verify if attributes of regulated habitat occur and delineate where possible. • Establish constraints for activities, where possible, that abide by timing windows and setback distances and avoid regulated habitat features • Narrow construction footprint if possible. • Flag or fence off environmentally sensitive areas prior to drainage work activity. Bury fencing a minimum of 10 – 20 cm and vertical height of at least 60 cm. Note, stakes should be installed on the activity side to prevent snake use of stakes to climb fence. • Complete wildlife sweep within the exclusion area following fence installation to ensure no trapped wildlife. • Staff/workers conducting drainage works should be trained in snake species identification and procedures if encountered (review and sign off form in Contractor Information Package) • One staff member/worker or qualified biologist should be trained in proper snake handling procedures and protocols outlined in Section 2 of the Ontario Species at Risk Handling Manual: For Endangered Species Act Authorization Holders (Included in the Contractor Information Package). This person should be onsite at all times (when required) for the potential capture, temporary holding, transfer and release of any snakes encountered during construction. A minimum of two holding tubs and cotton sacks should be onsite at all times. • Prior to commencement of daily drainage work activity, the area should be cleared of snakes through machinery inspections (e.g. wheels, engine compartment) each morning and after machinery is left idle for more than one (1) hour if left on site during the snake active season. • If a nest is uncovered during drainage work activity: <ul style="list-style-type: none"> ◦ Collect any displaced or damaged eggs and transfer them to a holding tub ◦ Capture and transfer all injured dispersing juveniles of that species into a light-coloured drawstring cotton sack ◦ Place all cotton sacks with the captured injured individuals into a holding tub out of direct sunlight ◦ Immediately contact the MNRF to seek direction and to arrange for transfer of the injured individuals ◦ Immediately stop any disturbance to the nest site and loosely cover exposed portions with soil or organic material to protect the integrity of the remaining individuals ◦ Do not drive over the nest site or conduct any activities within 5 m of the nest site ◦ Do not place any dredged materials removed from drainage works on top of the nest site ◦ Mark out the physical location of the nest site but not by any means that might increase the susceptibility of the nest to predation or poaching ◦ Where there are no collected eggs or captured individuals, contact the MNRF within 24 hours to provide information on the location of the nest • Any injured captured snakes should be stored outside of direct sunlight and the MNRF should immediately be contacted to seek direction and to arrange for transfer. MNRF may require transfer to the nearest MNRF authorized Wildlife Rehabilitator. Contact Information for Authorized Wildlife Rehabilitator can be found in SAR Information Sheets (Appendix F). • If conducting drainage works during a species sensitive timing window and one or more individuals belonging to a snake species is encountered or active hibernacula is discovered: <ul style="list-style-type: none"> ◦ Trained staff/worker or qualified biologist shall capture and transfer all injured and uninjured individual snakes of that species into individual light-coloured, drawstring cotton sacks ◦ Place cotton sacks into a holding tub ◦ Ensure that the holding tub with captured individuals is stored at a cool temperature to protect snakes from freezing until the individuals can be retrieved or transferred ◦ If an active hibernacula is uncovered cease all work and immediately, contact MNRF to seek advice and arrange for transfer and/or removal • If conducting drainage works outside of a species sensitive timing window and one or more individuals belonging to a snake species is encountered: <ul style="list-style-type: none"> ◦ Briefly stop the activity for a reasonable period of time to allow any uninjured individual snakes of that species to leave the work area ◦ If the individuals do not leave the work area after the activity is briefly stopped, trained staff/worker or qualified biologist shall capture all uninjured individuals and release them in accordance with the methods outlined below ◦ Where circumstances do not allow for the immediate release of captured uninjured individuals, they may be transferred into individual, light-coloured, drawstring cotton sacks before placing them into a holding tub which shall be stored out of direct sunlight for a maximum of 24 hours before releasing them in accordance with the methods outlined below ◦ Capture and transfer any individuals injured as a result of conducting drainage works into a holding tub separate from any holding tub containing uninjured individuals ◦ Store all captured injured individuals out of direct sunlight and immediately contact the MNRF to seek direction and to arrange their transfer • Uninjured individuals captured during drainage works, are to be released within 24 hours of capture, in an area immediately adjacent to the drainage works with natural vegetation cover within 50 m and out of harm's way (as per subsections 2.3 and 2.4 of Handling Manual included in the Contractor Information Package; Appendix F).

Common Name**Recommended Mitigation Measures to Avoid Impacts to SAR Snakes in Study Area**

- Uninjured individuals captured during drainage works, are to be released within 24 hours of capture, in an area immediately adjacent to the drainage works with natural vegetation cover within 50 m and out of harm's way (as per subsections 2.3 and 2.4 of Handling Manual included in the Contractor Information Package; **Appendix F**).
- Where one or more individuals belonging to a snake species is killed as a result of drainage work activity, or a person finds a deceased individual of a snake species, the following measures should be followed:
 - Collect and transfer any dead individuals into a holding tub outside of direct sunlight; and,
 - Contact the MNRF within 72 hours to seek direction and to arrange for the transfer of the carcasses of the dead individuals.
- If the methods of handling snakes outlined in subsection 2.3 and 2.4 of the Handling Manuals are not applicable due to a snake's injuries, use a shovel or flat object to pick up the snake, ensuring that injured areas are supported and place in a large plastic bin or bucket with a lid with air holes. Immediately transport the turtle to an MNRF authorized veterinarian or wildlife rehabilitator and contact the MNRF. Contact Information for Authorized Wildlife Rehabilitator can be found in **Appendix F** and on SAR Information Sheets (**Appendix F**).
- Complete a SAR Encounter Reporting Form included in Contractor Information Package (**Appendix F**).

7.2.2 Species Specific Mitigation Measures for Turtle Species

Turtles can generally be found associated with large slow moving water features that have logs or stumps for basking. For nesting, turtles prefer moist well drained, loose soils for digging and on a gradual typically south facing slope. Species such as Blanding’s Turtle and Spiny Softshell hibernate underwater in permanent waterbodies. Sensitive timing windows for turtle species includes the nesting period and has been provided in **Table 6**.

When conducting drainage works where there is potential for turtle species to be hibernating, water level **cannot be reduced** as per Paragraph 6 of subsection 13 of Section 23.9 of O.Reg. 242/08.

Table 6: Restricted Activity Period for Turtle Species

Month	Jan			Feb			Mar			Apr			May			Jun			Jul			Aug			Sep			Oct			Nov			Dec								
Date Codes ¹	E	M	L	E	M	L	E	M	L	E	M	L	E	M	L	E	M	L	E	M	L	E	M	L	E	M	L	E	M	L	E	M	L	E	M	L	E	M	L	E	M	L
Hibernation																																										

¹Monthly intervals: E = Early (days 1-10); M = Middle (days 11-20); L = Late (days 21-31). Adapted from the Seasonal Timing Windows Chart in the MNR Agreement under Section 23 of O.Reg. 242/08 made under ESA, 2007 (File #: AY-23D-010-10).

In **Table 7** below, the recommended mitigation measures to avoid impacts to turtle species during and outside sensitive timing windows and what to do when turtles or turtle nests are encountered is provided. Photographs of habitat observed within and adjacent to drains that have the potential to support SAR Turtles, have been included in **Appendix G** (Photographs #5 - 6).



Table 7: Mitigation Measures for Turtle Species

Common Name	Recommended Mitigation Measures to Avoid Impacts to SAR Turtles within the Study Area
Blanding's Turtle	<ul style="list-style-type: none"> • Preconstruction planning that includes review for potential habitat. • During site visit, verify if attributes of regulated habitat occur and delineate where possible. • Establish constraints for activities, where possible, that abide by timing windows, setback distances and avoid regulated habitat features. • Narrow construction footprint if possible. • Flag or fence off environmentally sensitive areas prior to drainage work activity. Bury fencing a minimum of 10 – 20cm and vertical height of at least 60 cm. • Complete wildlife sweep within the exclusion/construction area following fence installation to ensure no trapped wildlife. • Staff/workers conducting drainage works should be trained in turtle species identification and procedures if encountered (Review and sign off form in the Contractor Information Package; Appendix F). • One staff member/worker or qualified biologist should be trained in proper turtle handling procedures and protocols outlined in Section 1 of the Ontario Species at Risk Handling Manual: For Endangered Species Act Authorization Holders (provided in the Contractor Information Package; Appendix F). This person should be onsite at all times (when required) for the potential capture, temporary holding, transfer and release of any turtles encountered during construction. A minimum of two holding tubs and cotton sacks should be onsite at all times. • If construction is planned to commence during the turtle nesting period, prior to site preparation a turtle nesting search should be completed to identify turtle nests. If nests are encountered, the MNRF must be consulted immediately. Nests should be relocated to an appropriate facility for incubation with MNRF approval. Contact information for MNRF Authorized Wildlife Rehabilitator can be found in SAR Information Sheets (Appendix F). • Drainage work activity related to excavation of sediment or disturbance to banks should be avoided during the sensitive timing windows for turtles. • During turtle hibernation periods, water in drains or ditches cannot be reduced. • Prior to commencement of daily activity, the area should be cleared of turtles and turtle nests by a specially trained staff member or qualified biologist.
Spiny Softshell	<ul style="list-style-type: none"> • Do not disturb a turtle encountered laying eggs and do not conduct activities within 20 m of the turtle while it is laying eggs. • If conducting drainage works during a species sensitive timing window and one or more individuals belonging to a turtle species is encountered: <ul style="list-style-type: none"> ○ Trained staff/worker or qualified biologist shall capture and transfer all injured and uninjured individuals of that species to a holding tub ○ Capture and transfer all individuals injured as a result of the drainage work activity into a holding tub separate from any holding tub containing uninjured individuals ○ Ensure that the holding tub with captured individuals is stored at a cool temperature until the individuals can be retrieved or transferred ○ Contact the MNRF immediately to seek advice and arrange for transfer and/or removal • If a nest is uncovered during construction, immediately stop all activity near the nest. Cover the nest with soil or organic material. Do not drive within 5 m of the nest and contact the MNRF within 24 hours if no eggs or individuals were captured/collected. • Isolate material stockpile areas with fencing. • Any injured captured turtles should be stored outside of direct sunlight and the MNRF should immediately be contacted to seek direction and to arrange for transfer. • Machinery should be inspected each morning (e.g. under vehicles) for presence of turtles. • Uninjured individuals captured during drainage works, are to be released within 1 hour of capture, out of harm's way no more than 125 m of where it was found, unless absolutely necessary. If it is not possible to relocate the turtle within 125 m of the capture location, contact the MNRF for further direction. MNRF may require transport of turtle(s) to MNRF Authorized Wildlife Rehabilitator or Veterinarian. Contact information can be found in Appendix F. • If the methods of handling turtles outlined in subsection 1.3 of the Handling Protocol are not possible due to a turtle's injuries, use a shovel or flat object to pick up the turtle, ensuring that injured areas are supported and place in a large plastic bin or bucket with a lid with air holes. Immediately transport the turtle to an MNRF Authorized Wildlife Rehabilitator or Veterinarian and contact the MNRF. Contact Information for Authorized Wildlife Rehabilitator can be found in Appendix F and on SAR Information Sheets (Appendix F). See subsection 1.7 of the Handling Manual (included in the Contractor Information Package; Appendix F) for more details. • Complete a SAR Encounter Reporting Form included in the Contractor Information Package (Appendix F).

7.2.3 Species Specific Mitigation Measures for Aquatic Species

Review of background information including, DFO’s Aquatic SAR Mapping (Map 29 of 33), NHIC and MNRF Agreement² identified 10 fish and 10 mollusc species listed as endangered or threatened under the ESA, 2007 with occurrence records within and/or adjacent to the Study Area. Of the 20 aquatic SAR identified only two fish species have been included in the Plan based on the presence of suitable habitat within the Study Area drains.

Although suitable habitat for SAR mussel species was not identified during our background review and site visits, if at any time a mussel species (of any type) are encountered, stop work and contact DFO for direction on how to proceed. A SAR Information Sheet for mussels species found during the background review has been provided in **Appendix F**.

Watercourses and drains identified during the background review and subsequent field investigations found all features to be of warm water thermal regime and to support warm water fish species. **Table 8** below indicates the in-water timing window restriction for warm water fish species. **Table 9** provides a list of recommended measures to follow to avoid impacts to fish species. As previously mentioned, activities that affect a species listed in Table 1, subsection 2, Section 23.9 of O. Reg. 242/08 still require a permit to conduct drainage works (see **Appendix D** for details). DFO’s *Guidance for Maintaining and Repairing Municipal Drains in Ontario version 1.0* (2017) document should be consulted when conducting all drainage works.

Table 8: In-water Timing Window Restriction for Warm Water Fish Species

Month	Jan			Feb			Mar			Apr			May			Jun			Jul			Aug			Sep			Oct			Nov			Dec								
Date Codes ¹	E	M	L	E	M	L	E	M	L	E	M	L	E	M	L	E	M	L	E	M	L	E	M	L	E	M	L	E	M	L	E	M	L	E	M	L	E	M	L	E	M	L
In-water Restriction																																										

¹Monthly intervals: E = Early (days 1-10); M = Middle (days 11-20); L = Late (days 21-31). Adapted from the Seasonal Timing Windows Chart in the MNRF Agreement under Section 23 of O.Reg. 242/08 made under ESA, 2007 (File #: AY-23D-010-10).

² Agreement under Section 23 of O.Reg. 242/08 made under the ESA, 2007 (File # AY-23D-010-10).



Table 9: Mitigation Measures for Aquatic Species

Common Name	Recommended Mitigation Measures to Avoid Impacts to SAR Aquatic Species within the Study Area
Pugnose Shiner	<ul style="list-style-type: none"> • Consult with MNRF if in-water timing window restrictions cannot be adhered to. • Allow for fish salvage within the isolated work area prior to dewatering. • Limit duration of in-water work as much as possible. • Conduct in-stream work during periods of low flow to reduce the risk to fish and their habitat and to allow work in-water to be isolated from flows. • Schedule work to avoid wet, windy, and rainy periods that may increase erosion and sedimentation. Suspend in-stream work immediately if sedimentation is detected. • Implement water quality monitoring if required. • Ensure equipment is clean and free of leaks. Wash, refuel and service machinery and store fuel and other materials for the machinery in such a way as to prevent any deleterious substances from entering the water. • Alter activities to reduce disturbance to species and habitat and follow current DFO Measures to Avoid Harm
Spotted Gar	<ul style="list-style-type: none"> • If federally listed SAR fish are encountered or have the potential to be present, contact the DFO to review next steps. • If SAR encountered, complete a SAR Encounter Reporting Form that will be included in the annual reporting.



Based on our review of potential SAR birds to occur within the Study Area, the following mitigation measures are recommended while conducting drainage work activities:

Table 11: Mitigation Measures for Bird Species

Common Name	Recommended Mitigation Measures to Avoid Impacts to SAR Birds within the Study Area
Bobolink Eastern Meadowlark	<ul style="list-style-type: none"> • Planning activities should include review of area for potential habitat (including box culverts and bridges for Barn Swallow nests). • Limit construction footprint where possible. • Conduct work outside of the RAP for birds where possible. • Pre-construction activities should include bird nest sweeps if activities occur during migratory bird sensitive timing window identified in Table 10, above. • Protect active nests by flagging or fencing off an appropriate setback distance. • Suspend activity if active habitat is discovered that cannot be adequately setback from.
Barn Swallow	<ul style="list-style-type: none"> • Maintain habitat connections where possible during activities. • Implement measures to restore lost habitat/ habitat connections. • If sensitive habitat is on site, a qualified biologist should be on site daily. • If SAR encountered, complete a SAR Encounter Reporting Form that will be included in the annual submission to the MNRF.



7.2.5 Species Specific Mitigation Measures for Vegetation Communities

Potential impacts to plant SAR may include trampling by personnel or equipment, alteration of growing conditions (e.g. soil compaction, sunlight availability, and moisture regime), disturbance to localized seed bank and introduction of invasive species. Mitigation measures that will be incorporated during drainage work activities to minimize the impacts to adjacent forest communities and SAR vegetation include:

- Planning activities should include review of area for identification of potential SAR vegetation.
- Limit construction footprint where possible to minimize the disturbance to plant species.
- Installing temporary erosion and sediment control measures prior to activity, and maintaining them throughout activity, including routinely inspecting and repairing them, as required. Enhanced sediment and erosion control measures will be implemented for sensitive areas where SAR habitat has been identified within and abutting the work site.
- Vegetation that does not require removal for the purposes of construction will be protected through the installation and maintenance of temporary vegetation protection fencing (e.g. snow fencing or erosion sediment control fencing). This includes protection of any SAR trees identified.
- Equipment, materials and other construction activities will not be permitted in zones delineated for protection.
- If drainage work activity cannot be undertaken without disturbing a SAR plant(s), the Town should contact the MNRF for additional site-specific measures.
- Operational procedures and Best Management Practices for handling material and excess material, and spill prevention will be implemented. Vehicular and equipment maintenance and refuelling will be carried out in a controlled manner, and where applicable, at designated maintenance areas. Refuelling will not be permitted within 30 m of any forest, or watercourse.
- Stabilize and re-vegetate exposed soil surfaces as soon as possible following activities, using native groundcover seed mixes and plantings.



APPENDIX “REI-C”

STANDARD SPECIFICATIONS **FOR ACCESS BRIDGE CONSTRUCTION**

1. PRECAST CONCRETE BLOCK & CONCRETE FILLED JUTE BAG HEADWALLS

After the Contractor has set the endwall foundations and the new pipe in place, it shall completely backfill same and install new precast concrete blocks or concrete filled jute bag headwalls at the locations and parameters indicated on the drawing. All concrete used for headwalls shall be a minimum of 30 mPa at 28 days and include 6% +/- 1% air entrainment.

Precast concrete blocks shall be interlocking and have a minimum size of 600mmX600mmX1200mm. Half blocks shall be used to offset vertical joints. Cap blocks shall be a minimum of 300mm thick. A foundation comprising minimum 300mm thick poured concrete or precast blocks the depth of the wall and the full bottom width of the drain plus 450mm embedment into each drain bank shall be provided and placed on a firm foundation as noted below. The Contractor shall provide a levelling course comprising a minimum thickness of 150mm Granular "A" compacted to 100% Standard Proctor Density or 20mm clear stone, or a lean concrete as the base for the foundation. The base shall be constructed level and flat to improve the speed of installation. Equipment shall be provided as required and recommended by the block supplier for placing the blocks such as a swift lift device for the blocks and a 75mm eye bolt to place the concrete caps,. The headwall shall extend a minimum of 150mm below the invert of the access bridge culvert with the top of the headwall set to match the finished driveway grade, unless a 150mm high curb is specified at the edge of the driveway. To achieve the required top elevation, the bottom course of blocks and footing may require additional embedment into the drain bottom. The Contractor shall provide shop drawings of the proposed wall for approval by the Drainage Superintendent or Engineer prior to construction.

Blocks shall be placed so that all vertical joints are staggered. Excavation voids on the ends of each block course shall be backfilled with 20mm clear stone to support the next course of blocks above. Walls that are more than 3 courses in height shall be battered a minimum of 1 unit horizontal for every 5 units of vertical height. The batter shall be achieved by careful grading of the footing and foundation base, or use of pre-battered base course blocks. Filter cloth as specified below shall be placed behind the blocks to prevent the migration of any fill material through the joints. Backfill material shall be granular as specified below. Where the wall height exceeds 1.8 metres in height, a uni-axial geogrid SG350 or equivalent shall be used to tie back the walls and be installed in accordance with the manufacturer's recommendations. The wall face shall not extend beyond the end of the access bridge pipe. Non-shrink grout shall be used to fill any gaps between the blocks and the access bridge pipe for the full depth of the wall. The grout face shall be finished to match the precast concrete block walls as closely as possible.

When constructing the concrete filled jute bag headwalls, the Contractor shall place the bags so that the completed headwall will have a slope inward from the bottom of the pipe to the top of the finished headwall. The slope of the headwall shall be one unit horizontal to five units vertical. The Contractor shall completely backfill behind the new concrete filled jute bag headwalls with Granular "B" and Granular "A" material as per O.P.S.S. Form 1010 and the granular material shall be compacted in place to a Standard Proctor Density of 100%. The placing of the jute bag headwalls and the backfilling shall be performed in lifts simultaneously. The granular backfill shall be placed and compacted in lifts not to exceed 305mm (12") in thickness.

The concrete filled jute bag headwalls shall be constructed by filling jute bags with concrete. All concrete used to fill the jute bags shall have a minimum compressive strength of 25 MPa in 28 days and shall be provided and placed only as a wet mix. Under no circumstance shall the concrete to be used for filling the jute bags be placed as a dry mix. The jute bags, before being filled with concrete, shall have a dimension of 460mm (18") x 660mm (26"). The jute bags shall be filled with concrete so that when they are laid flat, they will be approximately 100mm (4") thick, 305mm (12") to 380mm (15") wide and 460mm (18") long.

The concrete jute bag headwall to be provided at the end of the bridge pipe shall be a single or double bag wall construction as set out in the specifications. The concrete filled bags shall be laid so that the 460mm (18") dimension is parallel with the length of the new pipe. The concrete filled jute bags shall be laid on a footing of plain concrete being 460mm (18") wide, and extending for the full length of the wall, and 305mm (12") thick extending below the bottom of the culvert pipe.

All concrete used for the footing, cap and bags shall have a minimum compressive strength of 30 mPa at 28 days and shall include 6% ± 1% air entrainment.

Upon completion of the jute bag headwall the Contractor shall cap the top row of concrete filled bags with a layer of plain concrete, minimum 100mm (4") thick, and hand trowelled to obtain a pleasing appearance. If the cap is made more than 100mm thick, the Contractor shall provide two (2) continuous 15M reinforcing bars set at mid-depth and equally spaced in

the cap. The Contractor shall fill all voids between the concrete filled jute bags and the corrugated steel pipe with concrete, particular care being taken underneath the pipe haunches to fill all voids.

The completed jute bag headwalls shall be securely embedded into the drain bank a minimum of 450mm (18") measured perpendicular to the sideslopes of the drain.

As an alternate to constructing a concrete filled jute bag headwall, the Contractor may construct a grouted concrete rip rap headwall. The specifications for the installation of a concrete filled jute bag headwall shall be followed with the exception that broken pieces of concrete may be substituted for the jute bags. The concrete rip rap shall be approximately 460mm (18") square and 100mm (4") thick and shall have two (2) flat parallel sides. The concrete rip rap shall be fully mortared in place using a mixture composed of three (3) parts of clean sharp sand and one (1) part of Portland cement.

The complete placement and backfilling of the headwalls shall be performed to the full satisfaction of the Drainage Superintendent and the Engineer.

2. QUARRIED LIMESTONE ENDWALLS

The backfill over the ends of the corrugated steel pipe shall be set on a slope of 1-½ units horizontal to 1 unit vertical from the bottom of the corrugated steel pipe to the top of each end slope and between the drain banks. The top 305mm (12") in thickness of the backfill over the ends of the corrugated steel pipe shall be quarried limestone. The quarried limestone shall also be placed on a slope of 1-½ units horizontal to 1 unit vertical from the bottom of the corrugated steel pipe to the top of each bank of the drain adjacent each end slope. The quarried limestone shall have a minimum dimension of 100mm (4") and a maximum dimension of 250mm (10"). The end slope protection shall be placed with the quarried limestone pieces carefully tamped into place with the use of a shovel bucket so that, when complete, the end protection shall be consistent, uniform, and tightly laid in place.

Prior to placing the quarried limestone end protection over the granular backfill and on the drain banks, the Contractor shall lay non-woven geotextile filter fabric "GMN160" conforming to O.P.S.S. 1860 Class I or approved equal. The geotextile filter fabric shall extend from the bottom of the corrugated steel pipe to the top of each end slope of the bridge and along both banks of the drain to a point opposite the ends of the pipe.

The Contractor shall take extreme care not to damage the geotextile filter fabric when placing the quarried limestone on top of the filter fabric.

3. BRIDGE BACKFILL

After the corrugated steel pipe has been set in place, the Contractor shall backfill the pipe with Granular "B" material, O.P.S.S. Form 1010 with the exception of the top 305mm (12") of the backfill. The top 305mm (12") of the backfill for the full width of the excavated area (between each bank of the drain) and for the top width of the driveway, shall be Granular "A" material, O.P.S.S. Form 1010. The granular backfill shall be compacted in place to a Standard Proctor Density of 100% by means of mechanical compactors. All of the backfill material, equipment used, and method of compacting the backfill material shall be inspected and approved and meet with the full satisfaction of the Drainage Superintendent and Engineer.

4. GENERAL

Prior to the work commencing, the Drainage Superintendent and Engineer must be notified, and under no circumstances shall work begin without one of them being at the site. Furthermore, the grade setting of the pipe must be checked, confirmed, and approved by the Drainage Superintendent or Engineer prior to continuing on with the bridge installation.

The alignment of the new bridge culvert pipe shall be in the centreline of the existing drain, and the placing of same must be performed totally in the dry.

Prior to the installation of the new access bridge culvert, the existing sediment build-up in the drain bottom must be excavated and completely removed. This must be done not only along the drain where the bridge culvert pipe is to be installed, but also for a distance of 3.05 metres (10 ft.) both upstream and downstream of said new access bridge culvert. When setting the new bridge culvert pipe in place it must be founded on a good undisturbed base. If unsound soil is encountered, it must be totally removed and replaced with 20mm (3/4") clear stone, satisfactorily compacted in place.

When doing the excavation work or any other portion of the work relative to the bridge installation, care should be taken not to interfere with, plug up, or damage any existing surface drains, swales, and lateral or main tile ends. Where damage is encountered, repairs to correct same must be performed immediately as part of the work.

The Contractor and/or landowner performing the bridge installation shall satisfy themselves as to the exact location, nature and extent of any existing structure, utility or other object that they may encounter during the course of the work. The Contractor shall indemnify and save harmless the Town, or the Municipality, the Engineer, and their staff from any damages which it may cause or sustain during the progress of the work. It shall not hold them liable for any legal action arising out of any claims brought about by such damage caused by it.

Where applicable, the Contractor and/or landowner constructing the new bridge shall be responsible for any damage caused by them to any portion of the Town road right-of-way. They shall take whatever precautions are necessary to cause a minimum of damage to same and must restore the roadway to its original condition upon completion of the works.

When working along a municipal roadway, the Contractor shall provide all necessary lights, signs, barricades and flagpersons as required to protect the public. All work shall be carried out in accordance with the requirements of the Occupational Health and Safety Act, and latest amendments thereto. If traffic control is required on this project, it is to comply with the M.T.O. Traffic Control Manual for Roadway Work Operations and Ontario Traffic Manual Book 7.

Once the bridge installation has been completed, the drain sideslopes directly adjacent the new headwalls and/or endwalls are to be completely restored including revegetation, where necessary.

All of the work required towards the installation of the bridge shall be performed in a neat and workmanlike manner. The general site shall be restored to its' original condition, and the general area shall be cleaned of all debris and junk, etc. caused by the work

All of the excavation, installation procedures, and parameters as above mentioned are to be carried out and performed to the full satisfaction of the Drainage Superintendent and Engineer.

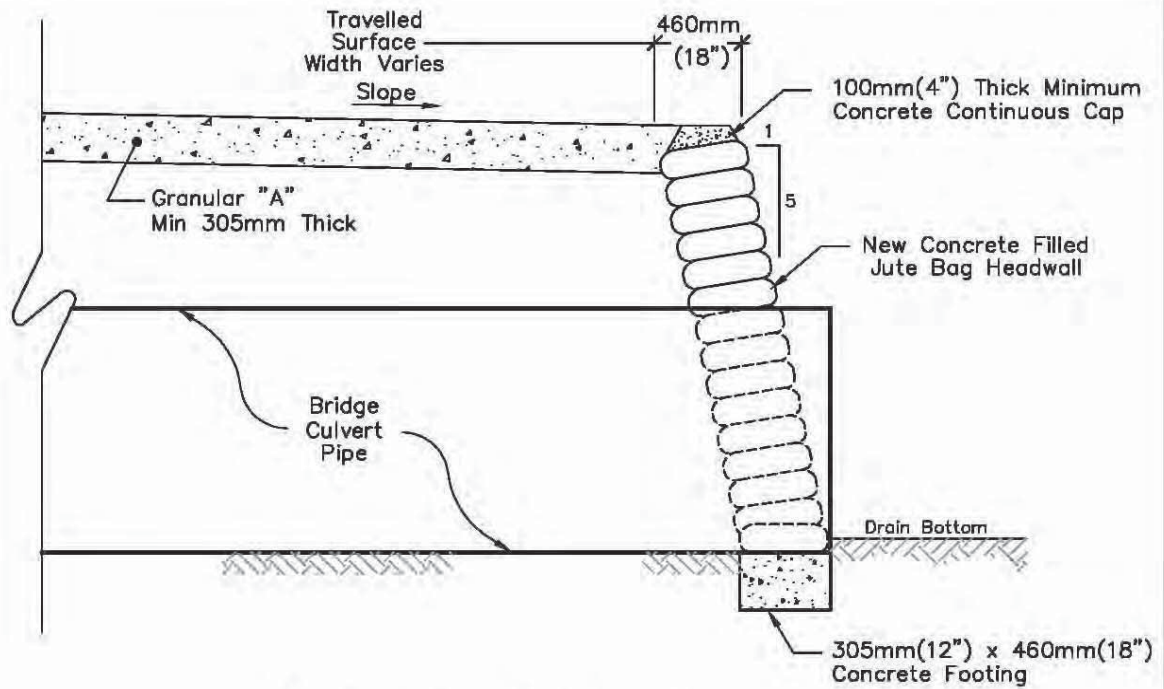

Typical Jute Bag Headwall

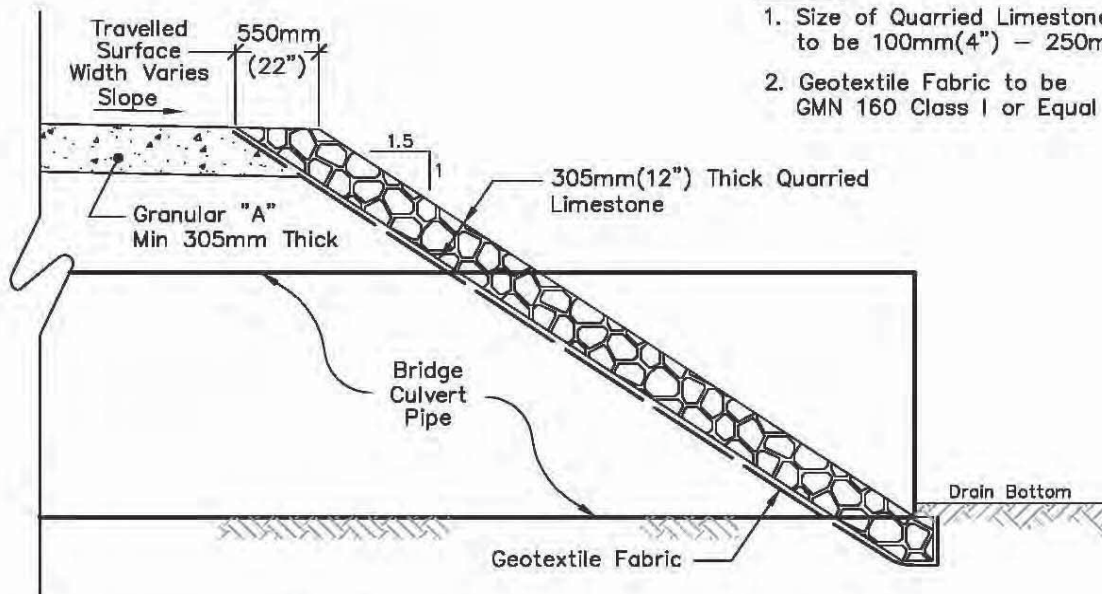

NOTE:

1. Size of Quarried Limestone to be 100mm(4") – 250mm(10")
2. Geotextile Fabric to be GMN 160 Class I or Equal

Typical Quarried Limestone End Protection

Rood Engineering Inc.

Consulting Engineers

9 Nelson Street

Leamington, Ontario N8H 1G6

519-322-1621

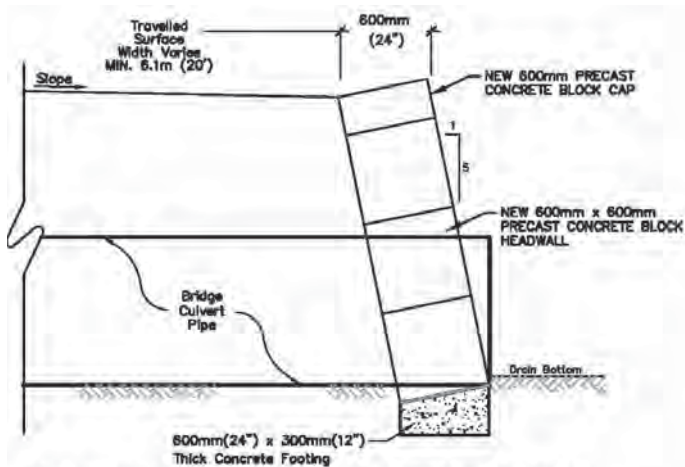
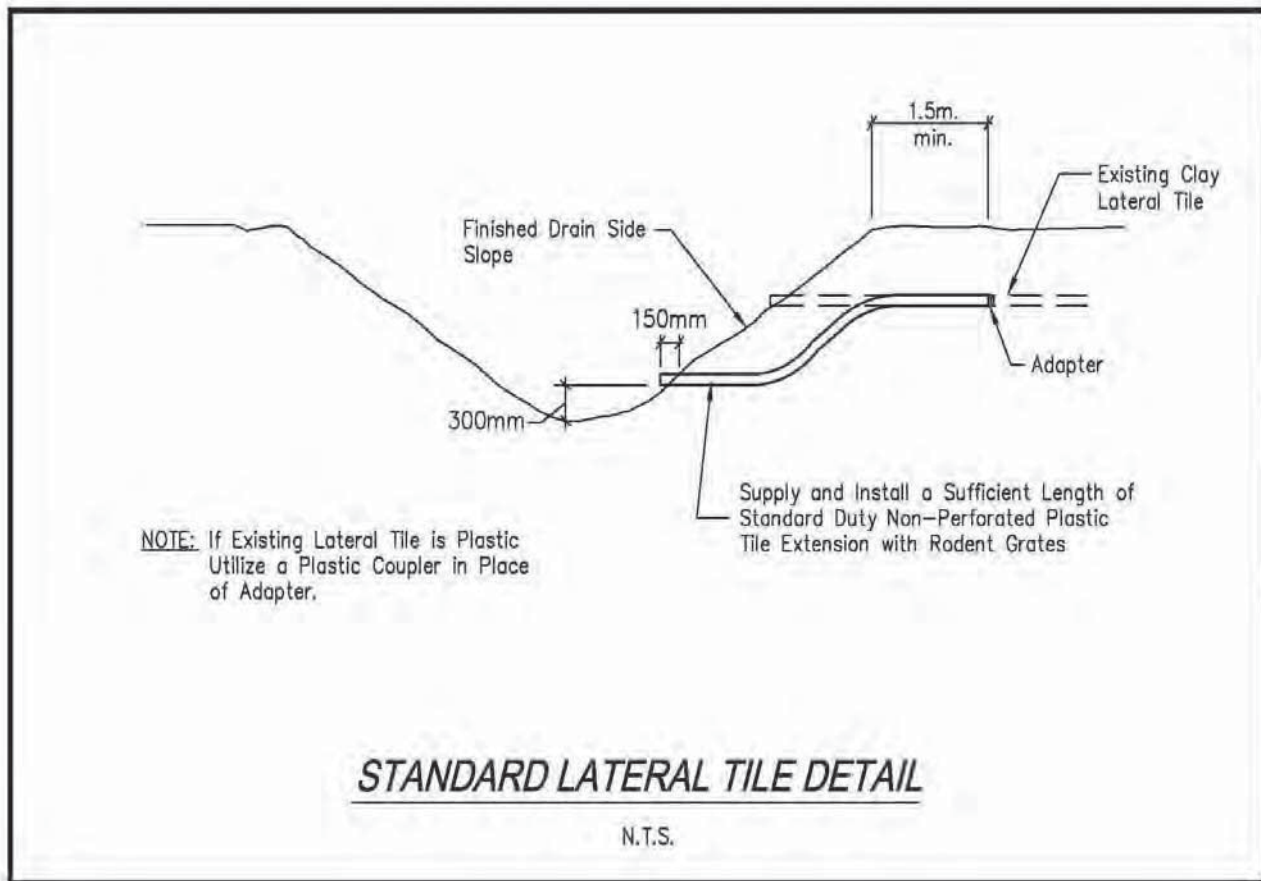

TYPICAL PRECAST CONCRETE BLOCK END PROTECTION
Scale = N.T.S.

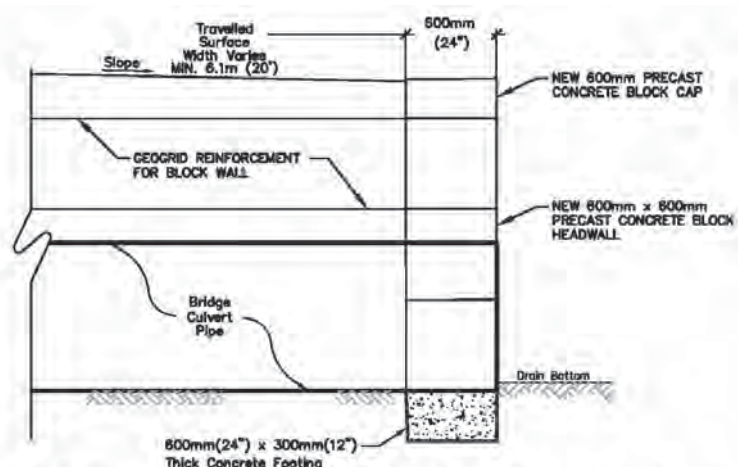

TYPICAL VERTICAL PRECAST CONCRETE BLOCK END PROTECTION
Scale = N.T.S.

APPENDIX “REI-D”

THE CORPORATION OF THE TOWN OF TECUMSEH

BY-LAW NO. 2007-51

Being a by-law to amend By-law No. 2007-41 to regulate the setting of open air fires and identify the precautions and conditions to be observed for such fires within The Corporation of the Town of Tecumseh.

WHEREAS Council considers excessive smoke, smell, airborne sparks or embers to be or could become or cause public nuisances by creating negative health effects on neighbouring residents, increasing fire exposure hazards, infringing the enjoyment of the use of neighbouring properties and generating false or nuisance alarms;

AND WHEREAS Council is empowered under Section 128 of the *Municipal Act* 2001, S.O. 2001, c. 25 as amended, to pass by-laws to prohibit and regulate public nuisances, including matters that, in the opinion of Council are, or could become or cause public nuisances;

AND WHEREAS in accordance with Section 425 of the *Municipal Act* 2001, S.O. 2001, c. 25 as amended, a municipality may pass by-laws providing that a person who contravenes a by-law of the municipality passed under this Act is guilty of an offence;

AND WHEREAS Section 444 of the *Municipal Act* 2001, c. 25 states if a municipality is satisfied that a contravention of a by-law of the municipality passed under this Act has occurred, the municipality may make an order requiring the person who contravened the by-law or who caused or permitted the contravention or the owner or occupier of the land on which the contravention occurred to discontinue the contravening activity;

AND WHEREAS the Council of The Corporation of the Town of Tecumseh enacted By-law No. 2007-41 on the 26th day of June, 2007 to regulate the setting of open air fires and identify the precautions and conditions to be observed for such fires within The Corporation of the Town of Tecumseh;

AND WHEREAS the Council of The Corporation of the Town of Tecumseh is desirous of amending By-law No. 2007-41;

NOW THEREFORE THE COUNCIL OF THE CORPORATION OF THE TOWN OF TECUMSEH ENACTS AS FOLLOWS:

1. **That** paragraph 4.9 be deleted and replaced with the following paragraph:
 - 4.9 Permitted fires, except those described in Section 4.4, shall,
 - a) be kept to manageable size that shall not be greater than one (1) square metre with flames no higher than one (1) metre in height; and,
 - b) in residentially zoned areas, be completely extinguished by 2:00 a.m.
2. **That** paragraph 5.2 be deleted and replaced with the following paragraph:
 - 5.2 An application for a Permit must be completed on the form/forms provided by the Tecumseh Fire/Rescue Services.

3. **That** paragraph 5.3 be deleted and replaced with the following paragraph:

5.3 An application must be filed with the Chief Fire Official of the Tecumseh Fire/Rescue Services. Approved permits must be retained and presented to an attending fire official in the event that there is a need for a fire official to attend at the burn location due to complaint.

4. **That** this by-law shall take full force and effect on the third and final reading.

READ a first, second, third time and finally passed this 11th day of September, 2007.

Gary McNamara, Mayor

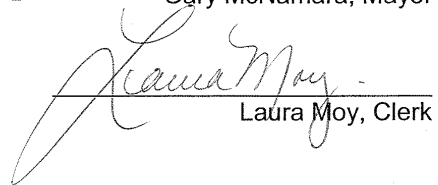
Laura Moy, Clerk

THE CORPORATION OF THE TOWN OF TECUMSEH

BY-LAW NUMBER 2007-41

A by-law to regulate the setting of open air fires and identify the precautions and conditions to be observed for such fires within The Corporation of the Town of Tecumseh.

WHEREAS Council considers excessive smoke, smell, airborne sparks or embers to be or could become or cause public nuisances by creating negative health effects on neighbouring residents, increasing fire exposure hazards, infringing on the enjoyment of the use of neighbouring properties and generating false or nuisance alarms;

AND WHEREAS Council is empowered under Section 128 of the *Municipal Act 2001*, S.O. 2001, c. 25 as amended, to pass bylaws to prohibit and regulate public nuisances, including matters that, in the opinion of Council are, or could become or cause public nuisances;

AND WHEREAS in accordance with Section 425 of the *Municipal Act 2001*, S.O. 2001, c. 25 as amended, a municipality may pass by-laws providing that a person who contravenes a by-law of the municipality passed under this Act is guilty of an offence;

AND WHEREAS Section 444 of the *Municipal Act 2001* c. 25 states if a municipality is satisfied that a contravention of a by-law of the municipality passed under this Act has occurred, the municipality may make an order requiring the person who contravened the by-law or who caused or permitted the contravention or the owner or occupier of the land on which the contravention occurred to discontinue the contravening activity;

AND WHEREAS Section 446(1) of the *Municipal Act 2001* c.25 states that if a municipality has the authority under this or any other Act or under a by-law under this or any other Act to direct or require a person to do a matter or thing, the municipality may:

- provide that, in default of it being done by the person directed or required to do it, the matter or thing shall be done at the person's expense;
- enter upon land at any reasonable time;
- recover the costs of doing a matter or thing from the person directed or required to do it by action or by adding the costs to the tax roll and collecting them in the same manner as property taxes; and
- that costs include interest calculated at a rate of 15 per cent or such lesser rate as may be determined by the municipality, calculated for the period commencing on the day the municipality incurs the costs;
- the costs, including interest, constitutes a lien on the land upon the registration in the proper land registry office of a notice of lien;

AND WHEREAS Section 390 of the *Municipal Act 2001* c.25 provides that a "person" includes a municipality and a local board and the Crown;

AND WHEREAS Section 426 of the *Municipal Act 2001* c. 25 provides that no person shall hinder or obstruct, or attempt to hinder or obstruct any person exercising a power or performing a duty under this Act or a by-law under this Act and that any person who contravenes subsection (1) is guilty of an offence;

NOW THEREFORE THE COUNCIL OF THE CORPORATION OF THE TOWN OF TECUMSEH ENACTS AS FOLLOWS:

1. DEFINITIONS

In this By-law:

- 1.1 "Burning Appliance" means any device designed or engineered to have a fire set within a contained area and totally enclosed by various means of screening and/or other methods.
- 1.2 "By-law Enforcement Officer" means the municipal person appointed by the Town of Tecumseh who shall be responsible for the enforcement of the provisions of this by-law.
- 1.3 "Chief Fire Official" means the Fire Chief of the Tecumseh Fire/ Rescue Services or designate.
- 1.4 "Competent Adult" means any person (18 years of age or older) who, in the opinion of those charged with enforcement of this By-Law, is capable of exercising the required judgement and capable of performing the necessary actions to control and prevent its unwanted spread.
- 1.5 "Farmer" means the owner or operator of an agricultural operation within an area zoned for agricultural pursuant to the *Farming & Food Protection Act*, 1998.
- 1.6 "Farmlands" means land designated "agricultural".
- 1.7 "Firefighter" means any person or any rank of person employed in, or appointed to the Tecumseh Fire/Rescue Services and assigned to undertake fire protection or fire prevention services.
- 1.8 "Full Cost Recovery Basis" has the meaning as described in Schedule "A" attached hereto.
- 1.9 "Open Air" means any open place, yard, field, lot, part lot or construction area which is not enclosed by a building or structure.
- 1.10 "Open Air Burning" means any fire set in the Open Air.
- 1.11 "Owner" means the registered owner or any person, firm or corporation having control over, or possession, of any portion of the building or property under consideration and includes the persons in the building or on the property.
- 1.12 "Permit" means a permit issued by the Chief Fire Official to set a fire in the Open Air for a specified date and period of time.
- 1.13 "Person" means an individual, business, a partnership or a corporation.
- 1.14 "Pit" means an area dug into the ground and/or surrounded by materials designed to contain the fire and prevent its spread to areas beyond the Pit.
- 1.15 "Police Officer" means any member of the Ontario Provincial Police.
- 1.16 "Tenant" means the occupant having possession or Person having control of a property or premises.
- 1.17 "Town" means The Corporation of the Town of Tecumseh.

2. ADMINISTRATION AND ENFORCEMENT

- 2.1 The Chief Fire Official shall be responsible for the administration of this by-law.
- 2.2 Enforcement of this by-law is the responsibility of the Chief Fire Official, any Fire-fighter, any Police Officer or any By-law Enforcement Officer.
- 2.3 The Chief Fire Official may refuse to issue a Permit or revoke any or all issued Permits.
- 2.4 The Fire Chief, Firefighters or Police Officers may, at all times enter and inspect any property or premises in order to ascertain whether the provisions of this by-law are complied with and to enforce or carry into effect the by-law.
- 2.5 Any person who fails to comply with the provisions of this by-law or fails to extinguish a fire once notification to do so has been given to him by the Chief Fire Official, a Police Officer or a Firefighter shall, in addition to any penalty provided herein, be liable to the municipality for all expenses incurred for the purposes of controlling and extinguishing of any fire so set or left to burn and such expenses may be recovered by court action or in a like manner as municipal taxes.

3. ENVIRONMENT

- 3.1 All Open Air Burning shall comply with the provisions of the *Environmental Protection Act*, R.S.O. 1990. c. E19.
- 3.2 No Open Air Burning shall be permitted when a smog alert has been issued for the region of Essex County, which includes the Town.
- 3.3 No Open Fire shall be started or maintained when wind condition is in such direction or intensity so as to cause any or all of the following:
 - (a) decrease in visibility on any highway or roadway;
 - (b) threaten a rapid spread of fire through a grass or brush area;
 - (c) smoke which causes annoyance or irritation to adjacent persons, properties or premises.

4. GENERAL PROVISIONS

- 4.1 No Person being the Owner or Tenant in possession of lands within the Town shall allow a fire to be set or burn on such lands unless a Permit has been obtained.
- 4.2 No Person shall allow a fire to be set or burned exceeding the requirements of Sections 4.8 and 4.9.
- 4.3 Notwithstanding any provisions herein, no Person shall set or maintain a fire,
 - (a) in contravention of the *Ontario Fire Code*, the *Environmental Protection Act* or any other statutory requirements of the Province of Ontario or the Government of Canada;
 - (b) where the consumption of material or size and area of the fire will exceed the limits set by the Chief Fire Official and/or listed within this by-law in Sections 4.8 and 4.9.

- 4.4 (a) No Permit shall be required for domestic barbeques or permanent outdoor fireplaces used solely for the cooking of food on a grill and extinguished immediately upon completion of the cooking process or any Burning Appliance, or a Pit or open area where the requirements of Sections 4.8 and 4.9 are not exceeded;
- (b) installation and location of Burning Appliances must meet the manufacturer's specifications.
- 4.5 (a) A farmer who intends to set or maintain a fire in the Open Air on a specified day for disposal of vegetable matter or vegetation on Farmlands which is normal and incidental for farming purposes shall obtain a Permit to cover the period of the proposed Open Air fire, and will be required to notify the Tecumseh Fire/Rescue Services for each day that the proposed Open Air fire will take place;
- (b) an Open Air fire shall be supervised by a Competent Adult equipped with sufficient equipment to control and contain the Open Air fire to prevent the spread of the Open Air fire that would endanger or put at risk other properties or premises;
- (c) an Open Air fire shall be restricted to daylight hours only;
- (d) an Open Air fire shall be surrounded by a tilled area wide enough to prevent an Open Air fire from jumping across the tilled area and to maintain the area of the burn to be no greater than one (1) hectare in size;
- (e) the leading edge of the flame of an Open Air fire shall not exceed thirty (30) metres in length.
- 4.6 No Person shall set any fire in the Open Air to burn asphalt products, tires, treated wood, construction materials or rubble, kitchen garbage or any garbage or trash, rubber plastics and like items.
- 4.7 No Person shall set any fire in the Open Air except where permitted and only in the presence of a Competent Adult. The Competent Adult shall not leave the burning operation until such time as the fire has been completely extinguished and there is no threat of re-ignition or spreading of the fire.
- 4.8 Every Person that starts a fire in the Open Air shall ensure that there are adequate tools and/or water on hand to contain or extinguish the fire.
- 4.9 Permitted fires, except those described in Section 4.4, shall be kept to manageable size that shall not be greater than one (1) square metre with flames no higher than one (1) metre in height.
- 4.10 Every Person who sets an Open Air fire in the Town of Tecumseh shall be:
- (a) responsible and liable for any damage to property or injury to person occasioned by said fire;
- (b) liable for all costs incurred by the Town of Tecumseh, including but not limited to, the Fire/Rescue Services, including personnel and other agencies called to control and extinguish said fire on a Full Cost Recovery Basis. All fees and charges to be paid under this subsection shall be payable in the manner and subject any interest and penalties set forth in paragraph 5 and 6 of the Administrative Fees and Charges By-law 2007-12, as may be amended or repealed from time to time;

(c) the fees and charges under this section shall not be payable by that class of persons which have obtained a permit for an Open Air fire and complied with the terms of such permit.

- 4.11 Notwithstanding the aforementioned sections listed herein, the Fire Chief may issue a Permit upon application and approve the setting of any fire subject to the fire being adequately supervised and controlled through special conditions addressed by the Chief Fire Official.
- 4.12 No fire shall be set to dispose of commercial, industrial or construction waste or other like materials in areas zoned for commercial or industrial occupancies and such aforementioned materials shall not be transported to residential or agricultural areas for burning purposes.
- 4.13 No fires shall be set at construction and/or demolition sites for the purpose of disposing of waste, building material or rubble.

5. FIRES REQUIRING PERMITS

- 5.1 Except as provided in section 4.3 of this by-law, no Person shall set, maintain or cause to be set or maintained, a fire in the Open Air unless a Permit has been issued by the Chief Fire Official.
- 5.2 An application for a Permit must be completed on the form/forms provided by the Tecumseh Fire/Rescue Services. Such forms are available to fill out by telephone call to Tecumseh Fire Station No. 1, Monday to Friday from 08:30 hr to 16:30 hr.
- 5.3 Each completed application for a Permit must be filed with the Chief Fire Official of the Tecumseh Fire/Rescue Services, at the administration offices located at 985 Lesperance Road, Tecumseh, Ontario.
- 5.4 In issuing a Permit under this part for Open Air Burning, the Chief Fire Official may impose any additional requirements or conditions as may be deemed necessary.

6. OFFENCES

- 6.1 (a) Any person who contravenes any of the provisions of this by-law is guilty of an Offence;
- (b) any person who hinders or obstructs a person lawfully carrying out the enforcement of this by-law is guilty of an Offence.

7. FINES

- 7.1 Every Person who is convicted of an Offence is liable to a Fine of not more than Five Thousand (\$5,000.00) Dollars as provided for in the *Provincial Offences Act*, R. S.O. 1990, Chap. P.33.

8. SEVERABILITY

- 8.1 If any section or sections of this by-law or parts thereof are found in any court to be illegal or beyond the power of Council to enact, such section or sections or parts thereof shall be deemed severable and all other sections or parts of this by-law shall be deemed separate and independent there from and enacted as such.

9. **SHORT TITLE**

9.1 The short title of this by-law shall be TECUMSEH OPEN AIR BURNING BY-LAW.

10. **EFFECTIVE DATE**

10.1 This by-law shall come into full force and take effect on the 1st day of July, 2007.

11. **REPEAL**

11.1 By-law No. 2005-57 is hereby repealed.

READ a first, second, third time and finally passed this 26th day of June, 2007.

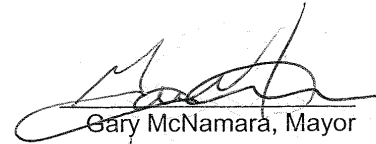

Gary McNamara, Mayor

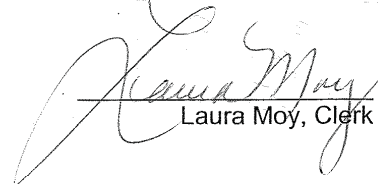

Laura Moy, Clerk

SCHEDULE "A"
By-law Number 2007-41

THE CORPORATION OF THE TOWN OF TECUMSEH
TECUMSEH FIRE/RESCUE SERVICES EQUIPMENT SERVICES RATES

"Full Cost Recovery Basis" includes any and all charges and costs howsoever incurred by the Town directly or indirectly in controlling and extinguishing the Open Air fire and shall include without limitations:

Emergency Services Rendered:

- (a) \$350.00 first hour or part thereof per piece of equipment;
- (b) \$175.00 each additional half-hour or part thereof per piece of equipment;
- (c) \$42.00 first hour or part thereof per firefighter who responds to the call;
- (d) \$27.50 for each additional hour or part thereof per firefighter until all equipment is cleaned, checked and returned to service;
- (e) the cost of all extinguishing agents required to extinguish the fire.

No Emergency Services Rendered:

- (a) \$350.00 flat rate per piece of equipment where services are not required nor provided;
- (b) \$42.00 flat rate per firefighter who responds to the call for service.

APPENDIX “REI-E”

WATERSHED PLAN, PROFILE, SECTIONS, & BRIDGE PLANS

OF THE

SULLIVAN CREEK DRAIN

(Geographic Township of Sandwich South)

IN THE TOWN OF TECUMSEH

IN THE COUNTY OF ESSEX • ONTARIO

GERARD ROOD, P.ENG.

ROOD ENGINEERING INC.

CONSULTING ENGINEERS
Leamington, Ontario
519-322-1621



DATE: MARCH 1st, 2022

TOWN OF TECUMSEH

MAYOR: Gary McNamara
CLERK: Laura Moy
DRAINAGE SUPERINTENDENT: Sam Paglia, P.Eng.

ROLL INFORMATION:

TOWN OF TECUMSEH:

- | | | | |
|--|--|--|---|
| 1. Michael Lutsch
460-01000 MN 6098 | 31. Kevin & Melissa McCarthy
480-08803 MN 5500 | 61. Joseph & Helen Diesbourg
520-03400 MN 9209 | 86. Philip, Rose & Paul Jobin
560-04000 |
| 2. Thomas Halford
460-01100 MN 5680 | 32. Ravinder & Mavi Singh
480-08900 MN 6703 | 62. Clifford & Connie Campeau
520-03500 | 87. Derek Battersby & Britney Brown
560-04010 MN 4250 |
| 3. Thomas & Linda Halford
460-01200 MN 8639 | 33. Rose Jobin & Jole Reyner
480-09000 MN 8639 | 63. Jacob Carlesimo
520-03800 MN 9801 | 88. Mary McGraw
560-08000 |
| 4. Rosemary Halford
460-01300 MN 5580 | 34. Tammy & John Flood
480-09010 MN 8559 | 64. Clifford & Connie Campeau
520-03900 MN 4327 | 89. 507822 Ontario Inc. & 494112 Ontario Limited
560-08100 |
| 5. Thomas Halford
460-01400 | 35. Jason Hill & Wendy Ouellette-Hill
480-09100 MN 8639 | 65. Clifford & Connie Campeau
520-03901 MN 4311 | 90. Phyllis Battersby
560-08200 |
| 6. Michael & Helen Lavin
460-01500 MN 5580 | 36. Jacqueline Mailoux
480-09110 MN 8719 | 66. Herbert Henricks & Marianne Scarpelli
520-03920 MN 4357 | 91. Canada Southern Railway Company
590-01000 |
| 7. John Lafferty
460-01600 | 37. Khmer Buddhist Santivaram Windsor
490-00100 MN 5300 | 67. Susanna Mackenzie-Russell
520-04000 MN 4397 | 92. Town of Tecumseh
590-01200 |
| 8. Frank & Catherine Lafferty
460-01601 | 38. 538073 Ontario Inc.
490-10200 | 68. Sanward Enterprises Inc.
520-04100 | CITY OF WINDSOR: |
| 9. Frank Lafferty Limited
490-01700 | 39. Robert & Richard McCarthy
490-10300 | 69. Edward Chittle Jr.
520-04200 | 93. Sandwich South Farms Limited
090-030-04700 |
| 10. Frank Lafferty
460-01800 MN 5369 | 40. Rose, Philip, Paul, Jole & Joslyne Jobin
510-01500 | 70. Jeremy Knezev
520-04250 MN 4505 | 94. 1027414 Ontario Inc.
090-030-04800 |
| 11. Transportation Ministry
460-01801 | 41. Rose Jobin
510-01550 | 71. Luigina Gobbo
520-04300 MN 4529 | 95. Rose Jobin
090-030-05000 MN 4856 |
| 12. Catherine Lafferty
460-01900 MN 5395 | 42. Philip Jobin
510-01590 MN 4780 | 72. Philip Jobin
520-04400 MN 4707 | 96. John Wilson
090-030-05200 MN 4800 |
| 13. 538073 Ontario Inc.
460-01901 | 43. Paul & Rose Jobin
510-01600 MN 4710 | 73. Sandwich South Farms Limited
520-04500 MN 4831 | 97. Norbert St. Louis
090-030-05400 MN 4732 |
| 14. Catherine Lafferty & Mary Thompson
460-02000 | 44. Philip Jobin
510-01610 | 74. Brian Chittle
520-04550 MN 4831 | 98. Gerald Lavin
090-030-05600 |
| 15. 538073 Ontario Inc.
460-02100 MN 6615 | 45. Wilfred O'Neil
510-01700 MN 4640 | 75. Steno Novelletta & Rosanne St. Louis
520-04600 MN 4835 | 99. 2017345 Ontario Limited
090-030-05850 |
| 16. Empty placeholder; skip ID No. 16 | 46. Wilfred O'Neil
510-01800 | 76. Gerald & Agnes Lavin
520-04700 MN 4995 | 100. 1741077 Ontario Inc.
090-030-06000 |
| 17. Empty placeholder; skip ID No. 17 | 47. Wilfred O'Neil
510-01900 | 77. Thomas & Mary Moore
520-04750 MN 5015 | 101. 1583925 Ontario Limited
090-030-06110 |
| 18. Alexander Chevalier & Jessie Darmon
480-08200 MN 6840 | 48. Ruth Battersby
510-02000 MN 4428 | 78. Wayne & Carol O'Neil
520-04800 MN 5235 | 102. 2187065 Ontario Limited
090-030-06200 MN 4310 |
| 19. Ali Khafaja
480-08250 MN 6812 | 49. James Battersby
510-02005 | 79. Deana & Mario Liburdi
560-08500 MN 3572 | 103. Robert Coupe
090-030-06300 MN 8355 |
| 20. Sandwich South Farms Inc.
480-08300 | 50. Laurie Knight
510-02010 MN 4372 | 80. Diklich Capital Corp.
530-00100 MN 7254 | 104. Thomas Crouchman
090-030-06400 MN 8475 |
| 21. Sandwich South Farms Inc.
480-08300 | 51. Helene Battersby
510-02100 MN 4320 | 81. Sanward Enterprises Inc.
530-04770 | 105. Gregory Maxwell
090-030-06500 MN 8515 |
| 22. Gerald & Agnes Lavin
480-08400 MN 6420 | 52. Rose Jobin
520-00700 | 82. Edward Chittle Jr.
530-04775 | 106. Joseph Gagnon
090-030-06600 MN 9039 |
| 23. Gerald & Agnes Lavin
480-08410 MN 6420 | 53. Rose, Philip & Paul Jobin, & Jobin Farms Inc.
520-00750 | 83. Lee Simpson
530-04800 MN 5427 | 107. Roussian Rokhoutine
090-030-06700 MN 9129 |
| 24. Joseph McCarthy
480-08500 MN 6084 | 54. Hardshean Brar
520-00900 MN 8280 | 84. Crossway Church
560-00300 MN 4215 | |
| 25. Richard McCarthy
480-08600 MN 5676 | 55. Union Gas Limited
520-01000 | 85. Susanna Mackenzie
560-03900 MN 4127 | |
| 26. Transportation Ministry
480-08611 | 56. Guy & Tina Robertson
520-01100 MN 5372 | | |
| 27. David & Margaret Pringle
480-08700 MN 5412 | 57. Charles Matthews
520-01210 MN 5296 | | |
| 28. Joseph & Marilyn McCarthy
480-08750 MN 5550 | 58. Kenneth & Barbara McCarthy
520-01300 MN 5056 | | |
| 29. 538073 Ontario Inc.
480-08800 | 59. Barbara McCarthy
520-01301 MN 5056 | | |
| 30. Josef Dworatschek
480-08801 MN 5450 | 60. Roger Lemmon
520-01350 MN 5000 | | |

BENCHMARKS:

- TOP MIDDLE OF SOUTH HEADWALL OF CONCRETE BRIDGE AT SOUTH TALBOT ROAD & WEST BRANCH OF DELUSIE DRAIN. **ELEV. = 191.812m**
- CUT CROSS AT TOP NORTHEAST CORNER OF HEADWALL OF CONCRETE BRIDGE AT GZOWSKI DRAIN & NORTH SIDE OF HIGHWAY NO. 3. **ELEV. = 189.897m**
- TOP MIDDLE OF SOUTH HEADWALL OF CONCRETE BRIDGE AT COUNTY ROAD 46 & SULLIVAN CREEK DRAIN. **ELEV. = 189.301m**
- TOP MIDDLE OF NORTH DECK OF CONCRETE BRIDGE AT HIGHWAY 401 & SULLIVAN CREEK DRAIN. **ELEV. = 186.113m**
- TOP NORTHWEST CORNER OF NORTH DECK OF CONCRETE BRIDGE AT BASELINE ROAD & SULLIVAN CREEK DRAIN. **ELEV. = 183.557m**
- TOP MIDDLE OF WEST HEADWALL OF CONCRETE BRIDGE AT 12TH CONCESSION ROAD & SULLIVAN CREEK DRAIN. **ELEV. = 182.943m**

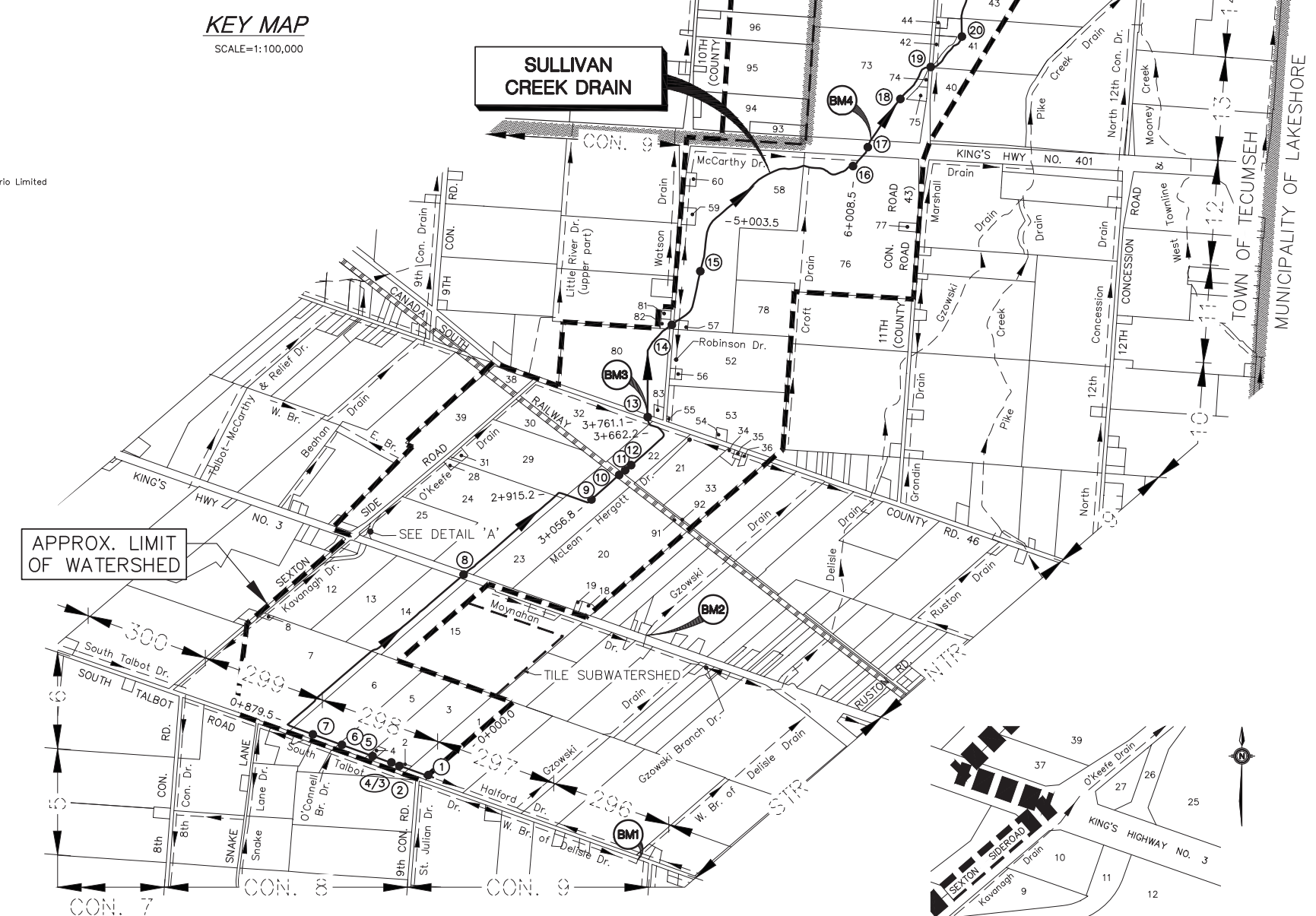
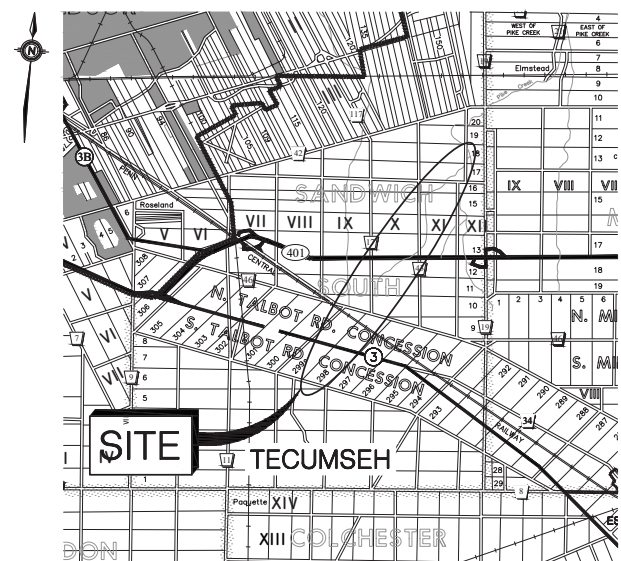

WATERSHED PLAN

SCALE=1:15,000

DETAIL 'A'

SCALE=1:3,000

THESE PLANS HAVE BEEN REDUCED AND THE SCALE THEREFORE VARIES. FULL SCALE PLANS MAY BE VIEWED AT THE MUNICIPAL OFFICE.

DRAWN BY: G.S. & S.H.
PLOT CODE: 1:1
COMPUTER FILE: RD20150010.DWG
FILE No.: 2015D010
SHEET No.: 1 OF 51

S:\SERVER\2019\VEI Data Server\DRAWINGS\PROJECTS\2015\RD-20150010 - Sullivan Creek Drain\Drawings\RD20150010 - Watershed Plan & Profiles.dwg

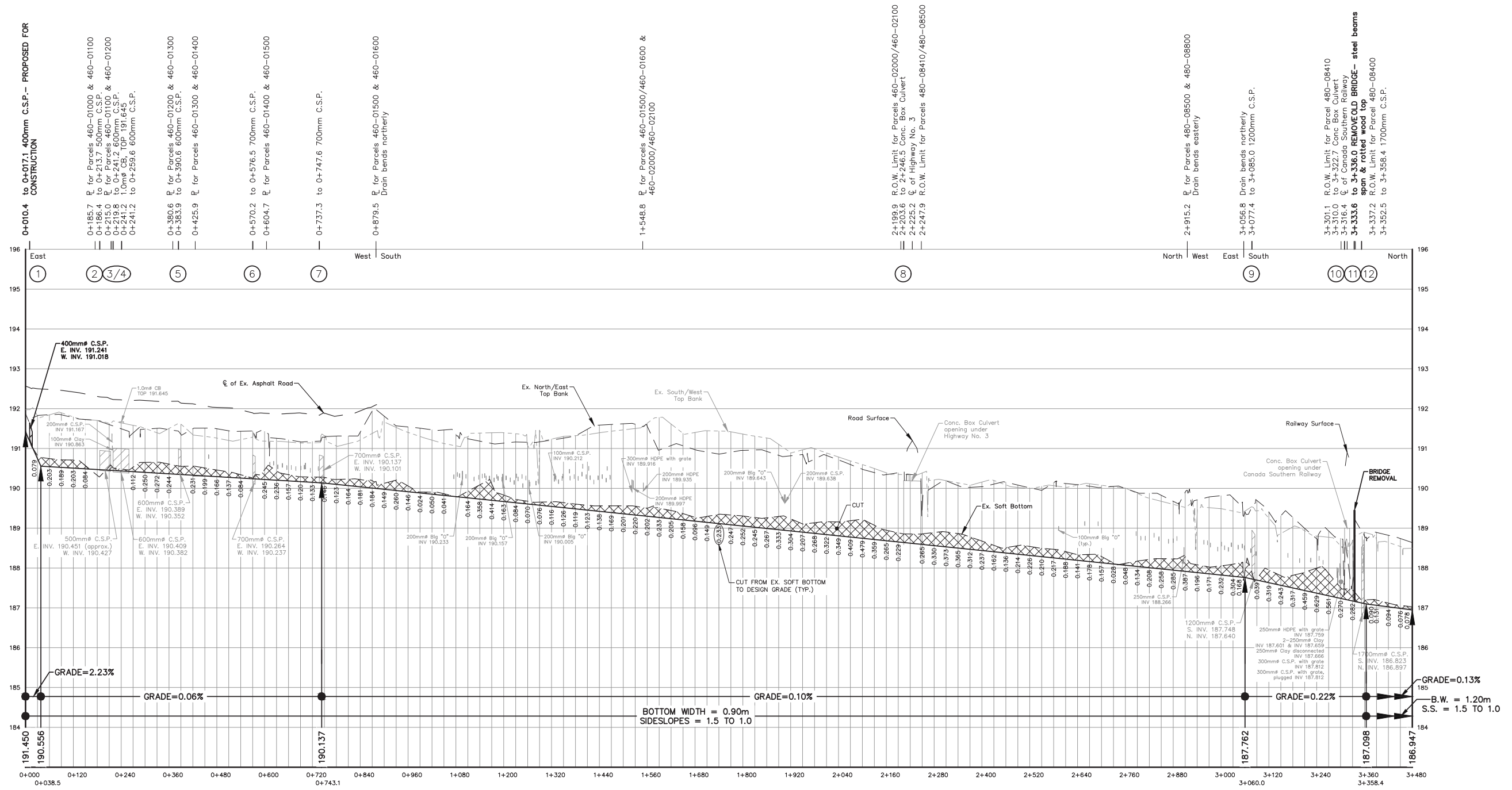

PROFILE OF SULLIVAN CREEK DRAIN— STA. 0+000 TO STA. 3+480

SCALE=1:5000 hor.
1:50 vert.

BENCHMARKS:

- TOP MIDDLE OF SOUTH HEADWALL OF CONCRETE BRIDGE AT SOUTH TALBOT ROAD & WEST BRANCH OF DELJSLE DRAIN.
ELEV. = 191.812m
- CUT CROSS AT TOP NORTHEAST CORNER OF HEADWALL OF CONCRETE BRIDGE AT GZOWSKI DRAIN & NORTH SIDE OF HIGHWAY NO. 3.
ELEV. = 189.897m
- TOP MIDDLE OF SOUTH HEADWALL OF CONCRETE BRIDGE AT COUNTY ROAD 46 & SULLIVAN CREEK DRAIN.
ELEV. = 189.301m
- TOP MIDDLE OF NORTH DECK OF CONCRETE BRIDGE AT HIGHWAY 401 & SULLIVAN CREEK DRAIN.
ELEV. = 186.113m
- TOP NORTHWEST CORNER OF NORTH DECK OF CONCRETE BRIDGE AT BASELINE ROAD & SULLIVAN CREEK DRAIN.
ELEV. = 183.557m
- TOP MIDDLE OF WEST HEADWALL OF CONCRETE BRIDGE AT 12TH CONCESSION ROAD & SULLIVAN CREEK DRAIN.
ELEV. = 182.581m

REFER TO SHEET 3 FOR PROFILE OF SULLIVAN CREEK DRAIN— STA 3+480 TO 6+960.
REFER TO SHEET 4 FOR PROFILE OF SULLIVAN CREEK DRAIN— STA 6+960 TO 9+962.9.

ROAD & RAILWAY \bar{C} CROSSINGS:

KING'S HIGHWAY NO. 3, STA 2+225.2	ELEV: 191.200m
CANADA SOUTH RAILWAY, STA 3+316.4	ELEV: 190.901m
COUNTY ROAD 46, STA 3+771.1	ELEV: 189.300m
10TH CONCESSION ROAD, STA 4+355.1	ELEV: 188.245m
KING'S HIGHWAY NO. 401, STA 6+108.2	ELEV: 186.853m (approx.)
11TH CONCESSION ROAD, STA 6+688.9	ELEV: 185.655m
BASELINE ROAD, STA 8+795.3	ELEV: 183.907m
12TH CONCESSION ROAD, STA 9+839.5	ELEV: 182.537m

THESE PLANS HAVE BEEN REDUCED AND THE SCALE THEREFORE VARIES. FULL SCALE PLANS MAY BE VIEWED AT THE MUNICIPAL OFFICE.

Sullivan Creek Drain REI2015D010.dwg, 2015-08-10

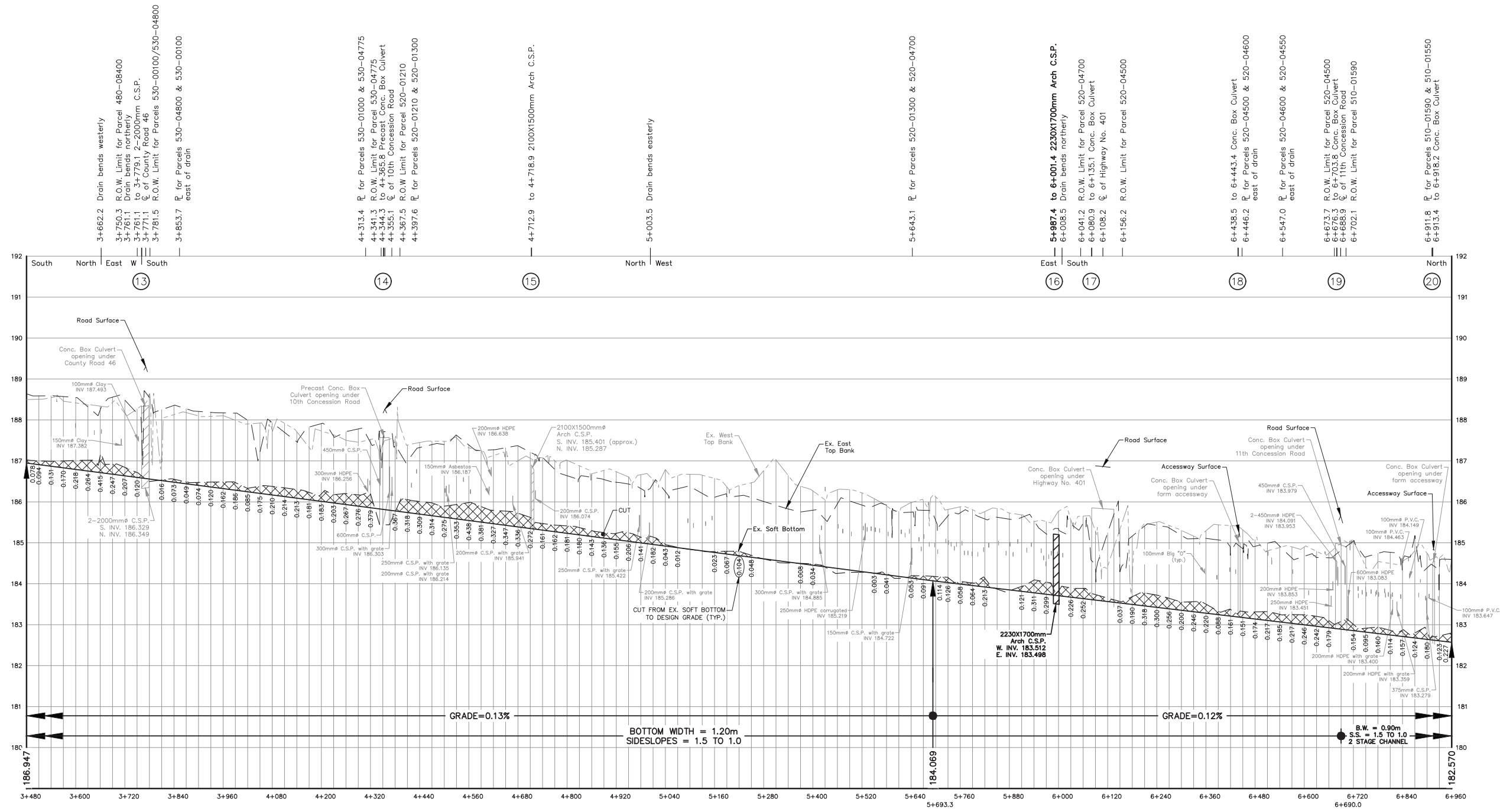

PROFILE OF SULLIVAN CREEK DRAIN- STA. 3+480 TO STA. 6+960

SCALE=1:5000 hor.
1:50 vert.

BENCHMARKS:

- TOP MIDDLE OF SOUTH HEADWALL OF CONCRETE BRIDGE AT SOUTH TALBOT ROAD & WEST BRANCH OF DELISLE DRAIN.
ELEV. = 191.812m
- CUT CROSS AT TOP NORTHEAST CORNER OF HEADWALL OF CONCRETE BRIDGE AT GZOWSKI DRAIN & NORTH SIDE OF HIGHWAY NO. 3.
ELEV. = 189.897m
- TOP MIDDLE OF SOUTH HEADWALL OF CONCRETE BRIDGE AT COUNTY ROAD 46 & SULLIVAN CREEK DRAIN.
ELEV. = 189.301m
- TOP MIDDLE OF NORTH DECK OF CONCRETE BRIDGE AT HIGHWAY 401 & SULLIVAN CREEK DRAIN.
ELEV. = 186.113m
- TOP NORTHWEST CORNER OF NORTH DECK OF CONCRETE BRIDGE AT BASELINE ROAD & SULLIVAN CREEK DRAIN.
ELEV. = 183.557m
- TOP MIDDLE OF WEST HEADWALL OF CONCRETE BRIDGE AT 12TH CONCESSION ROAD & SULLIVAN CREEK DRAIN.
ELEV. = 182.581m

REFER TO SHEET 2 FOR PROFILE OF SULLIVAN CREEK DRAIN- STA 0+000 TO 3+480.
REFER TO SHEET 4 FOR PROFILE OF SULLIVAN CREEK DRAIN- STA 6+960 TO 9+962.9.

ROAD & RAILWAY ? CROSSINGS:

- | | |
|-------------------------------------|---------------------------------|
| KING'S HIGHWAY NO. 3, STA 2+225.2 | ELEV. 191.200m |
| CANADA SOUTH RAILWAY, STA 3+316.4 | ELEV. 190.901m |
| COUNTY ROAD 46, STA 3+771.1 | ELEV. 189.300m |
| 10TH CONCESSION ROAD, STA 4+355.1 | ELEV. 188.245m |
| KING'S HIGHWAY NO. 401, STA 6+108.2 | ELEV. 186.853m (approx.) |
| 11TH CONCESSION ROAD, STA 6+688.9 | ELEV. 185.655m |
| BASELINE ROAD, STA 8+795.3 | ELEV. 183.907m |
| 12TH CONCESSION ROAD, STA 9+839.5 | ELEV. 182.537m |

THESE PLANS HAVE BEEN REDUCED AND THE SCALE THEREFORE VARIES. FULL SCALE PLANS MAY BE VIEWED AT THE MUNICIPAL OFFICE.

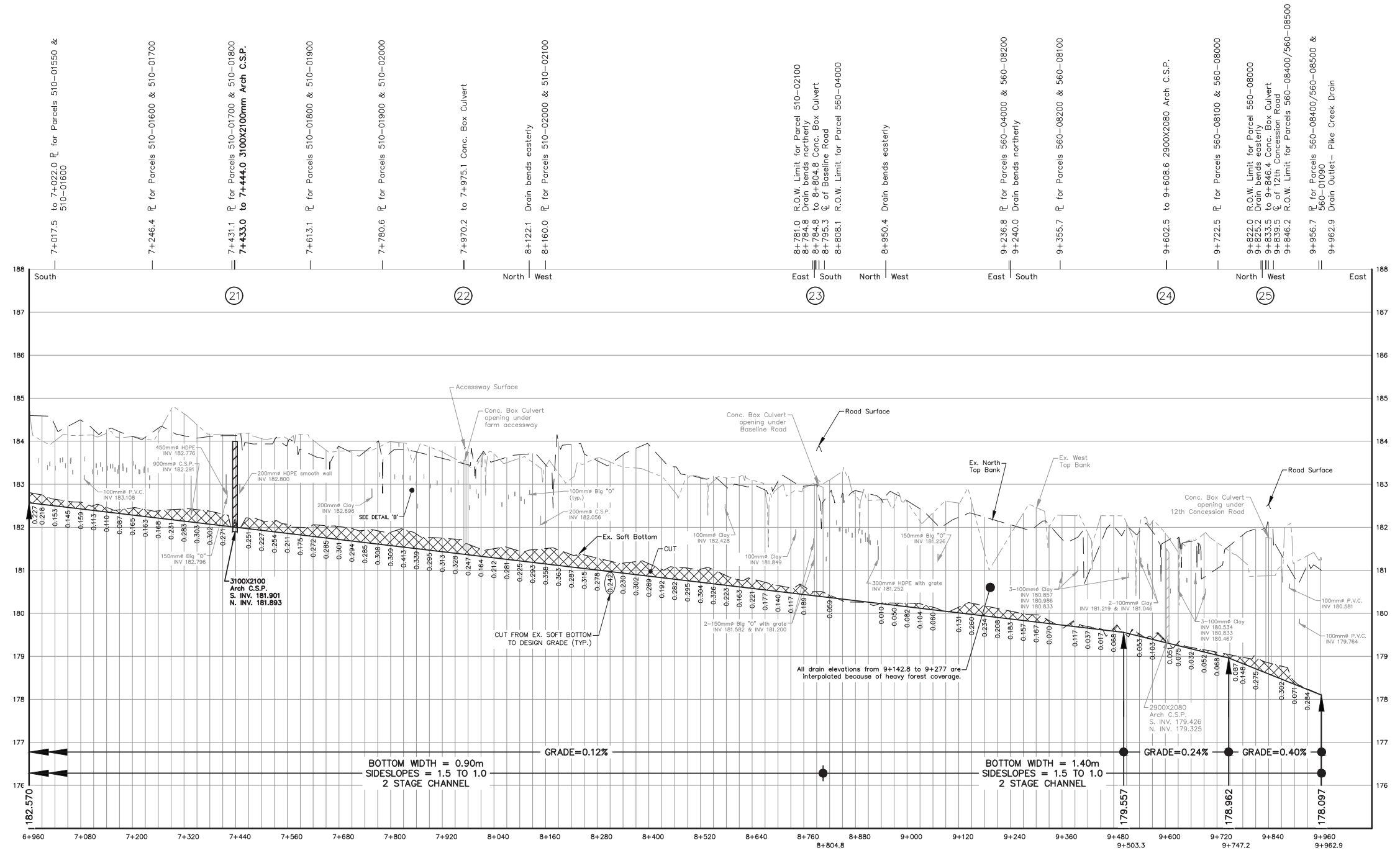

PROFILE OF SULLIVAN CREEK DRAIN- STA. 6+960 TO STA. 9+962.9

SCALE=1:5000 hor.
1:50 vert.

BENCHMARKS:

- TOP MIDDLE OF SOUTH HEADWALL OF CONCRETE BRIDGE AT SOUTH TALBOT ROAD & WEST BRANCH OF DELSIE DRAIN.
ELEV. = 191.812m
- CUT CROSS AT TOP NORTHEAST CORNER OF HEADWALL OF CONCRETE BRIDGE AT GZOWSKI DRAIN & NORTH SIDE OF HIGHWAY NO. 3.
ELEV. = 189.897m
- TOP MIDDLE OF SOUTH HEADWALL OF CONCRETE BRIDGE AT COUNTY ROAD 46 & SULLIVAN CREEK DRAIN.
ELEV. = 189.301m
- TOP MIDDLE OF NORTH DECK OF CONCRETE BRIDGE AT HIGHWAY 401 & SULLIVAN CREEK DRAIN.
ELEV. = 186.113m
- TOP NORTHWEST CORNER OF NORTH DECK OF CONCRETE BRIDGE AT BASELINE ROAD & SULLIVAN CREEK DRAIN.
ELEV. = 183.557m
- TOP MIDDLE OF WEST HEADWALL OF CONCRETE BRIDGE AT 12TH CONCESSION ROAD & SULLIVAN CREEK DRAIN.
ELEV. = 182.581m

REFER TO SHEET 2 FOR PROFILE OF SULLIVAN CREEK DRAIN- STA 0+000 TO 3+480.
REFER TO SHEET 3 FOR PROFILE OF SULLIVAN CREEK DRAIN- STA 3+480 TO 6+960.

ROAD & RAILWAY ? CROSSINGS:

- | | |
|-------------------------------------|---------------------------------|
| KING'S HIGHWAY NO. 3, STA 2+225.2 | ELEV. 191.200m |
| CANADA SOUTH RAILWAY, STA 3+316.4 | ELEV. 190.901m |
| COUNTY ROAD 46, STA 3+771.1 | ELEV. 189.300m |
| 10TH CONCESSION ROAD, STA 4+355.1 | ELEV. 188.245m |
| KING'S HIGHWAY NO. 401, STA 6+108.2 | ELEV. 186.655m (approx.) |
| 11TH CONCESSION ROAD, STA 6+688.9 | ELEV. 185.655m |
| BASELINE ROAD, STA 8+795.3 | ELEV. 183.907m |
| 12TH CONCESSION ROAD, STA 9+839.5 | ELEV. 182.537m |

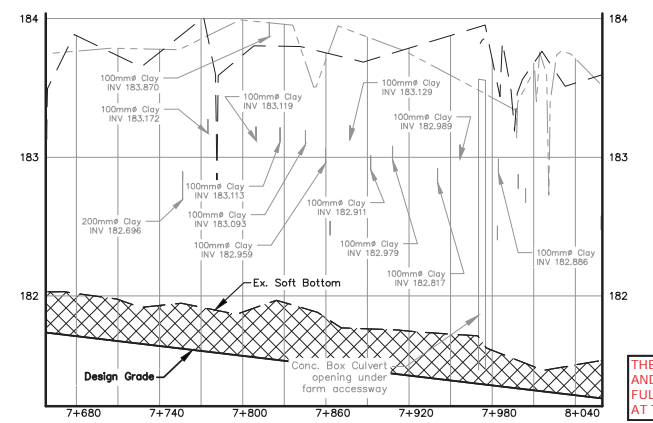

DETAIL 'B'

SCALE=1:2500 hor.
1:25 vert.

THESE PLANS HAVE BEEN REDUCED AND THE SCALE THEREFORE VARIES. FULL SCALE PLANS MAY BE VIEWED AT THE MUNICIPAL OFFICE.

S:\SERVER-2019\REI Data Server\DRAWINGS\PROJECTS\Projects 2015\REI-2015010 - Sullivan Creek Drain\Drawings\REI2015010_Materials Plan & Profiles.dwg

1

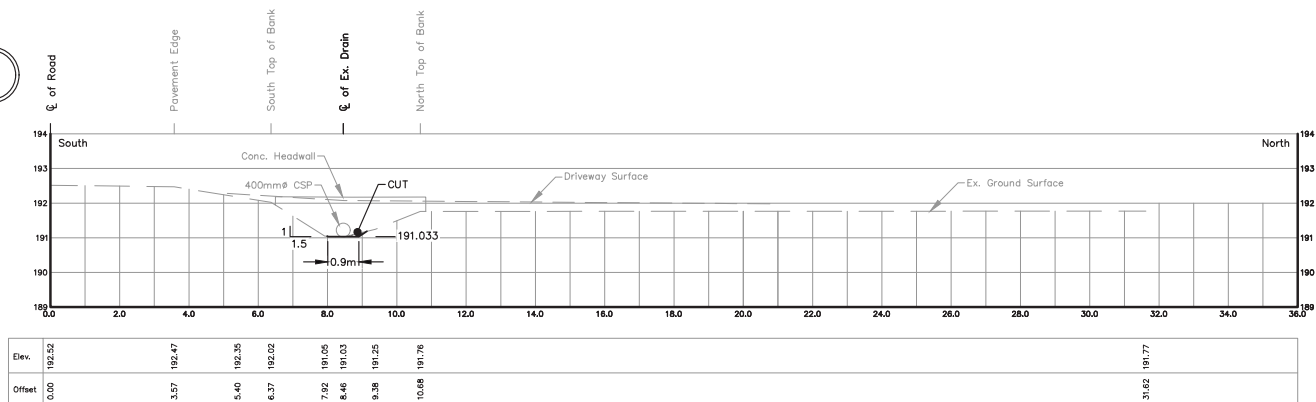

STA. 0+017.1
Scale = 1:100

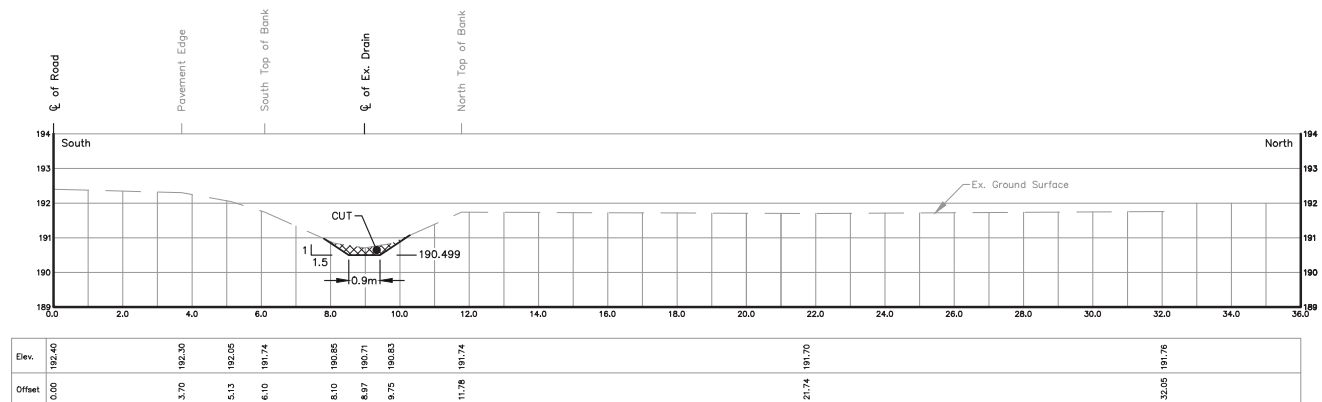

STA. 0+133.8
Scale = 1:100

1

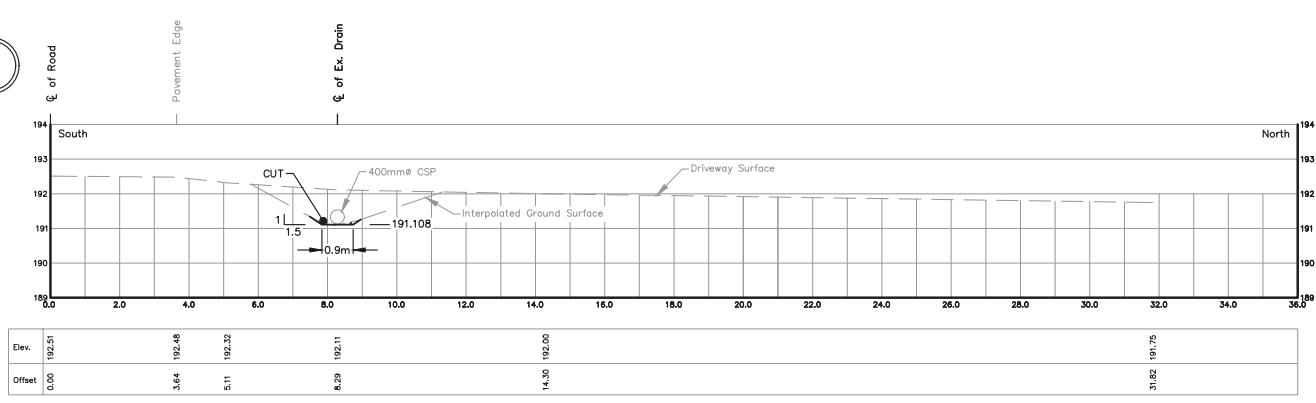

STA. 0+013.7
Scale = 1:100

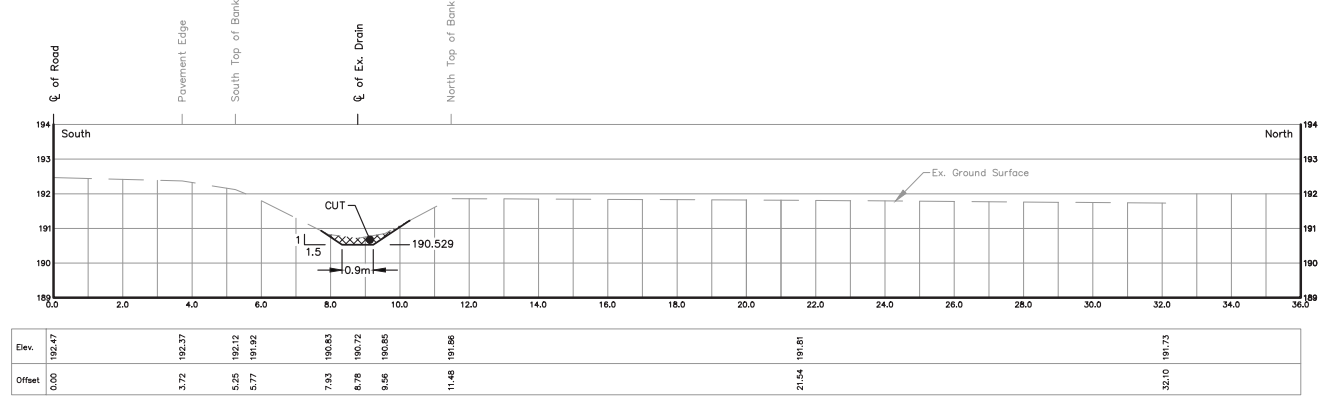

STA. 0+083.8
Scale = 1:100

1

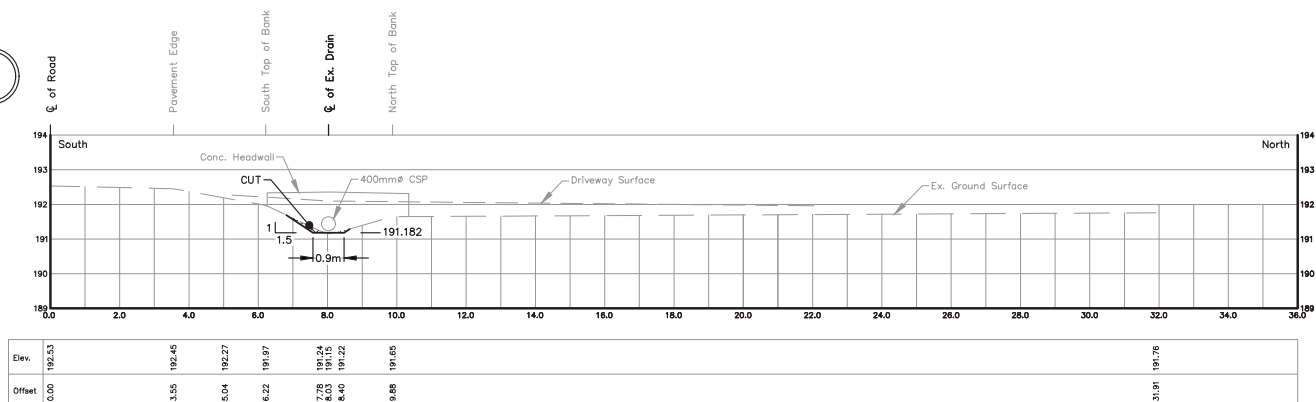

STA. 0+010.4
Scale = 1:100

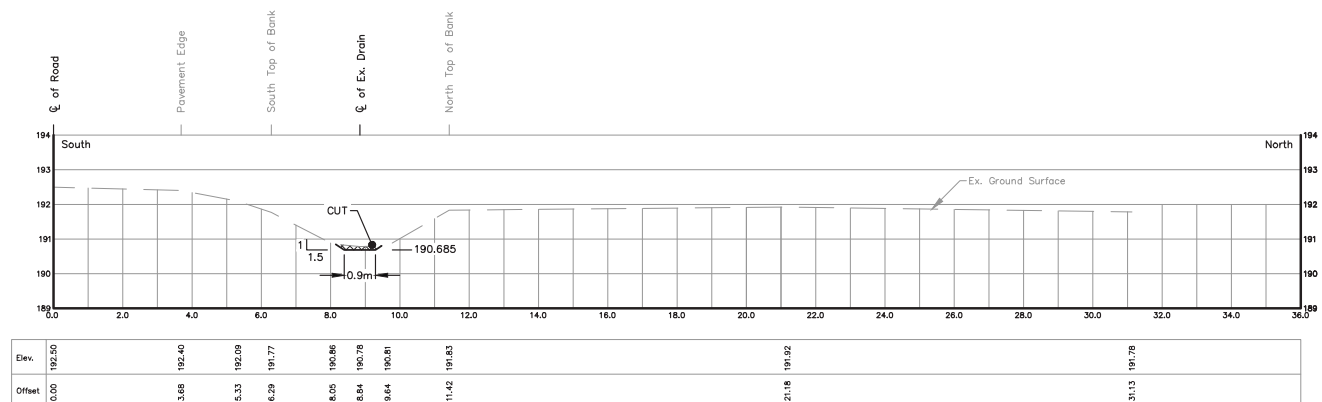

STA. 0+032.7
Scale = 1:100

THESE PLANS HAVE BEEN REDUCED AND THE SCALE THEREFORE VARIES. FULL SCALE PLANS MAY BE VIEWED AT THE MUNICIPAL OFFICE.

DRAWN BY: G.S. & S.H.
PLOT CODE: 1:1
COMPUTER FILE: REI2015D010.DWG
FILE No.: SHEET No.:
2015D010 5 OF 51

C:\Users\John\Desktop\REI-2015D010 - Sullivan Creek Drain\REI2015D010 - Sections July 2021-05-16

2

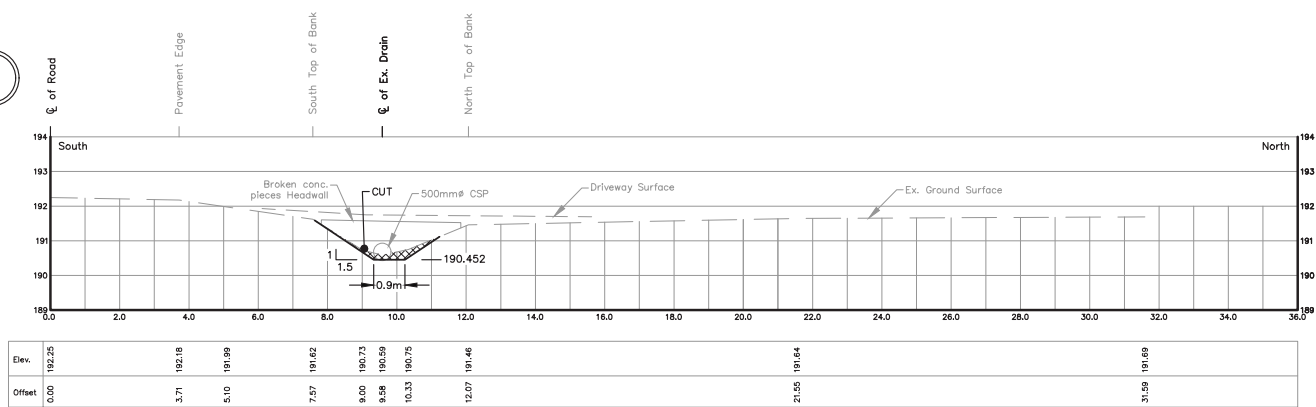

STA. 0+213.7
Scale = 1:100

4

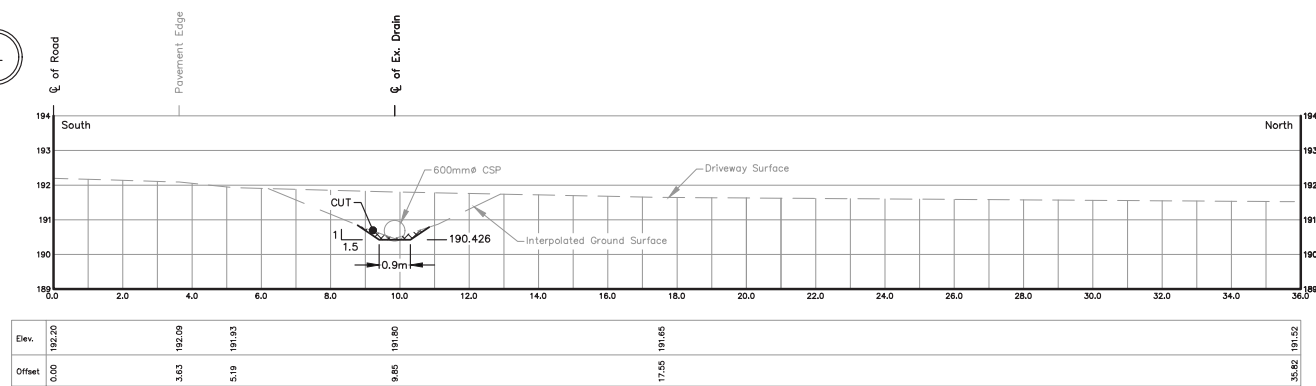

STA. 0+256.5
Scale = 1:100

2

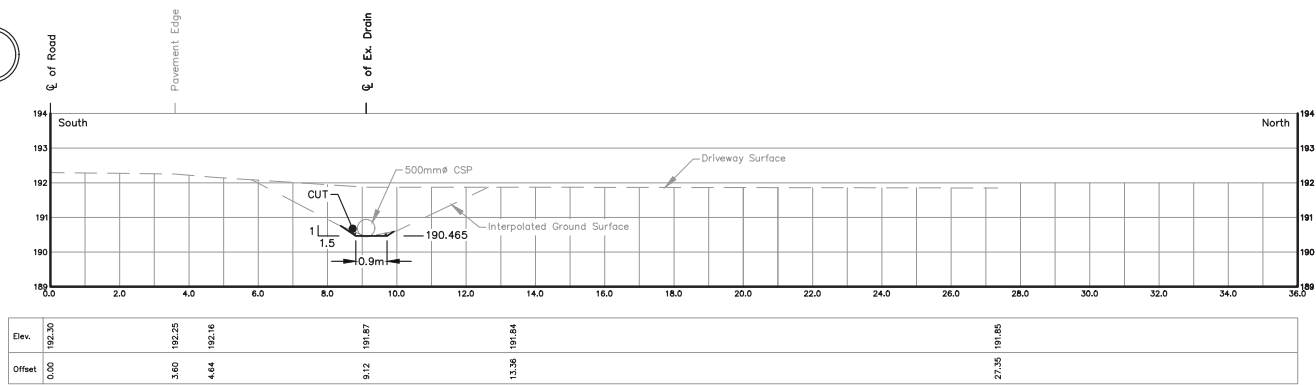

STA. 0+191.0
Scale = 1:100

3

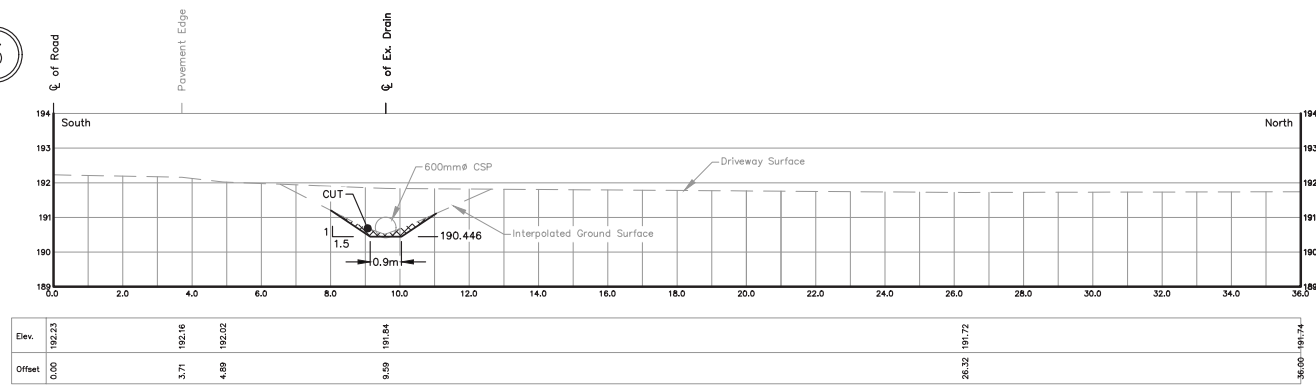

STA. 0+223.1
Scale = 1:100

2

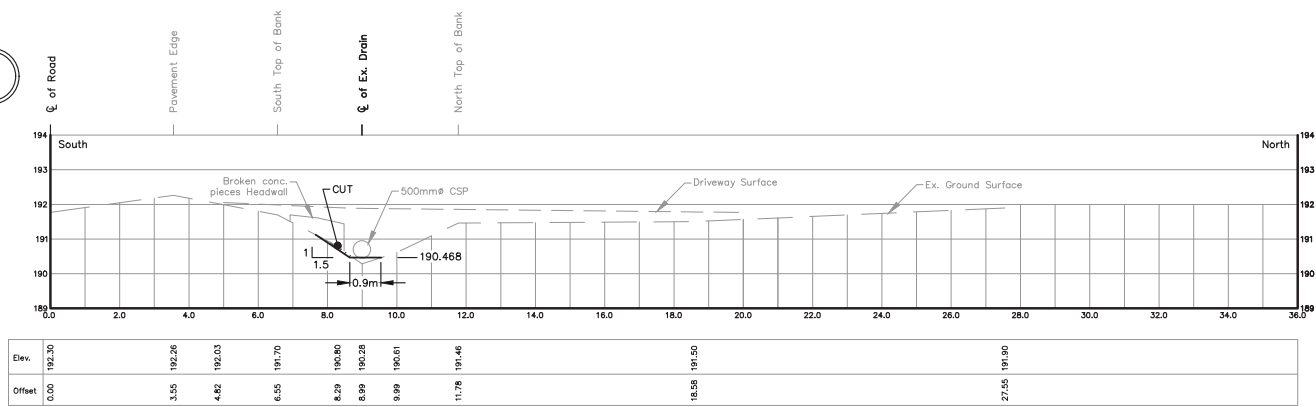

STA. 0+186.4
Scale = 1:100

3

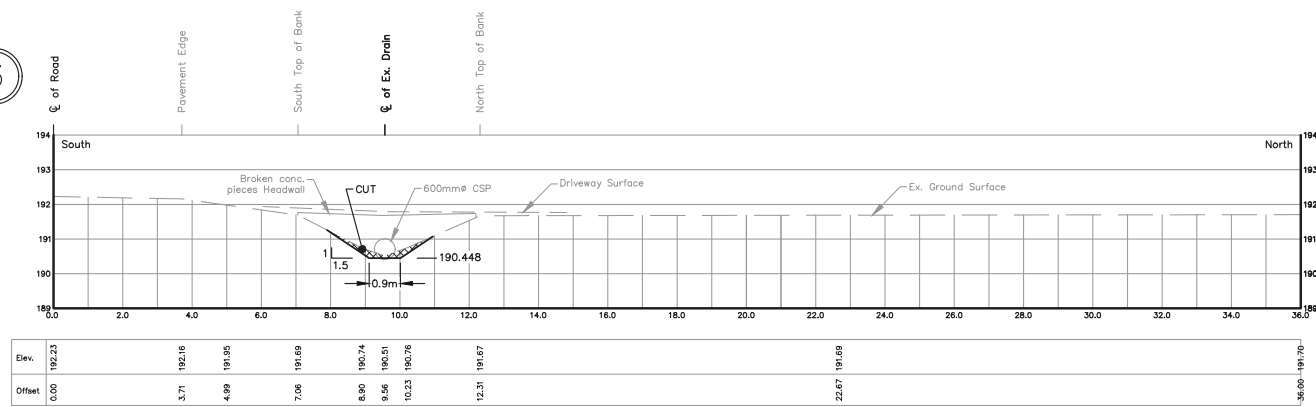

STA. 0+219.8
Scale = 1:100

THESE PLANS HAVE BEEN REDUCED AND THE SCALE THEREFORE VARIES. FULL SCALE PLANS MAY BE VIEWED AT THE MUNICIPAL OFFICE.

DRAWN BY: G.S. & S.H.
PLOT CODE: 1:1
COMPUTER FILE: REI2015D010.DWG
FILE No.: 2015D010
SHEET No.: 6 OF 51

C:\Users\John\Desktop\REI-20150010 - Sullivan Creek Drain\REI20150010 - Sections A.dwg 2021-05-16

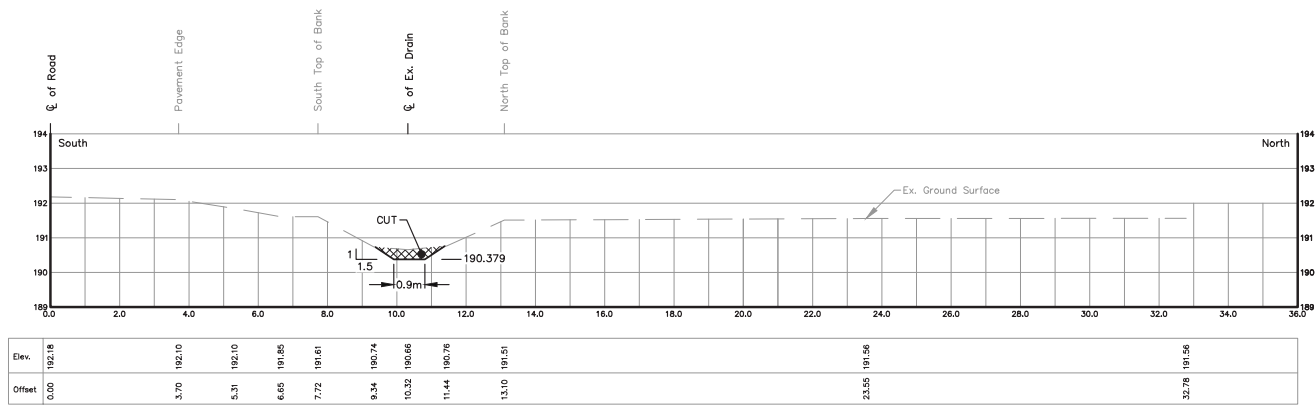

STA. 0+336.1
Scale = 1:100

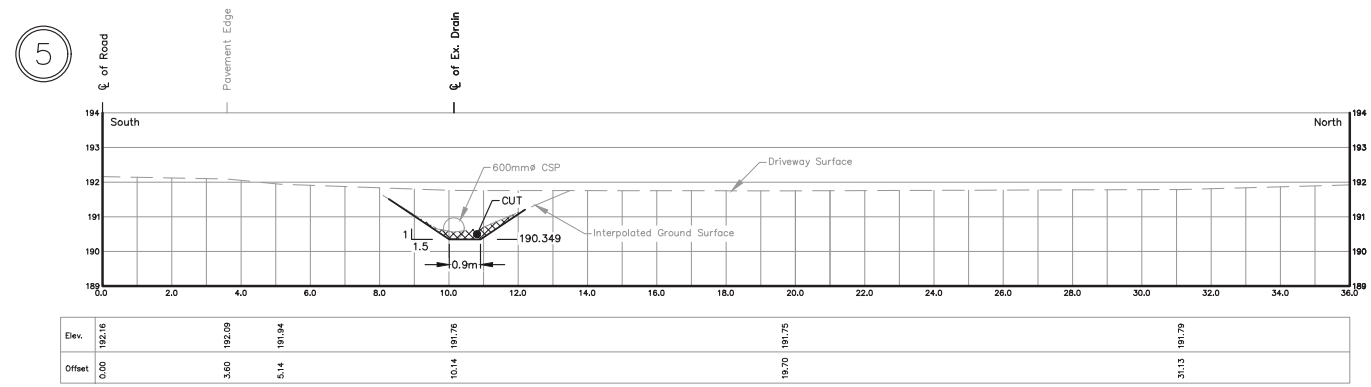

STA. 0+387.2
Scale = 1:100

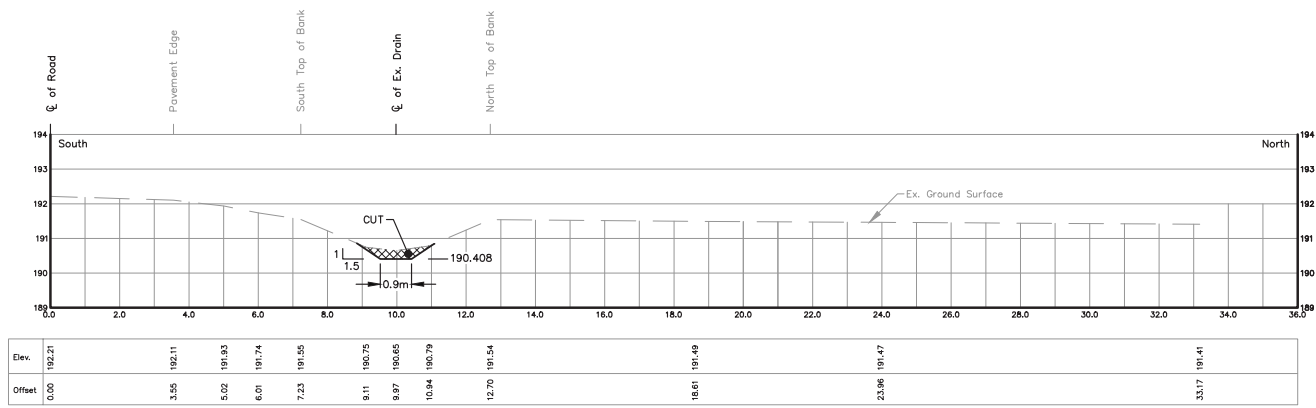

STA. 0+286.6
Scale = 1:100

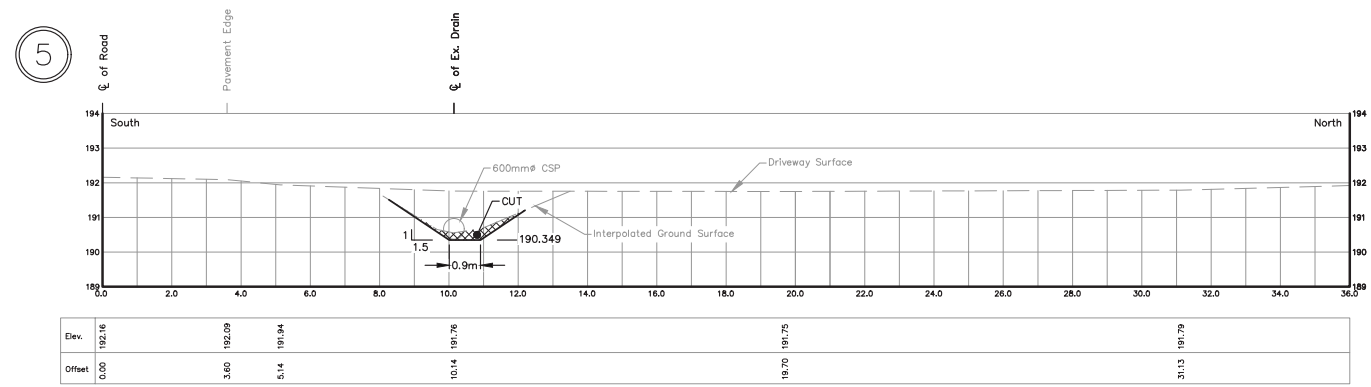

STA. 0+387.2
Scale = 1:100

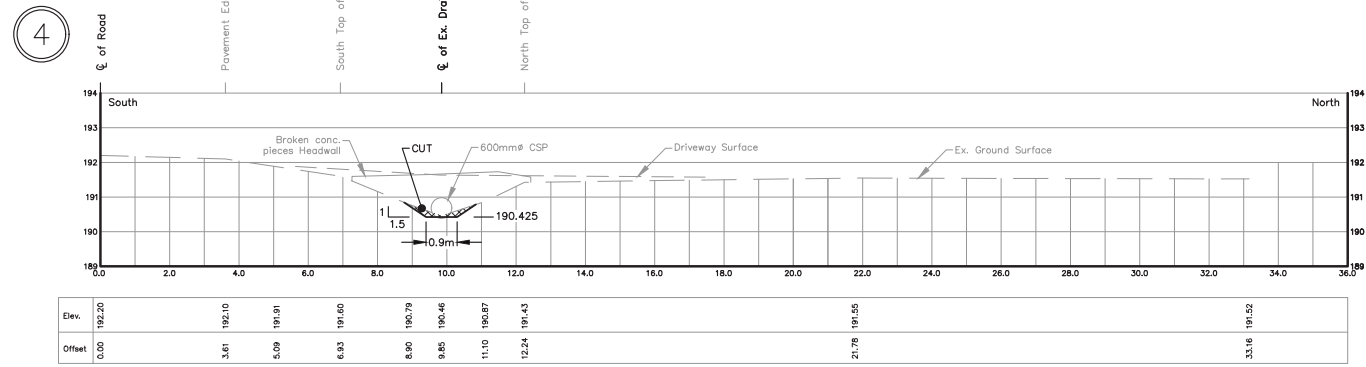

STA. 0+259.6
Scale = 1:100

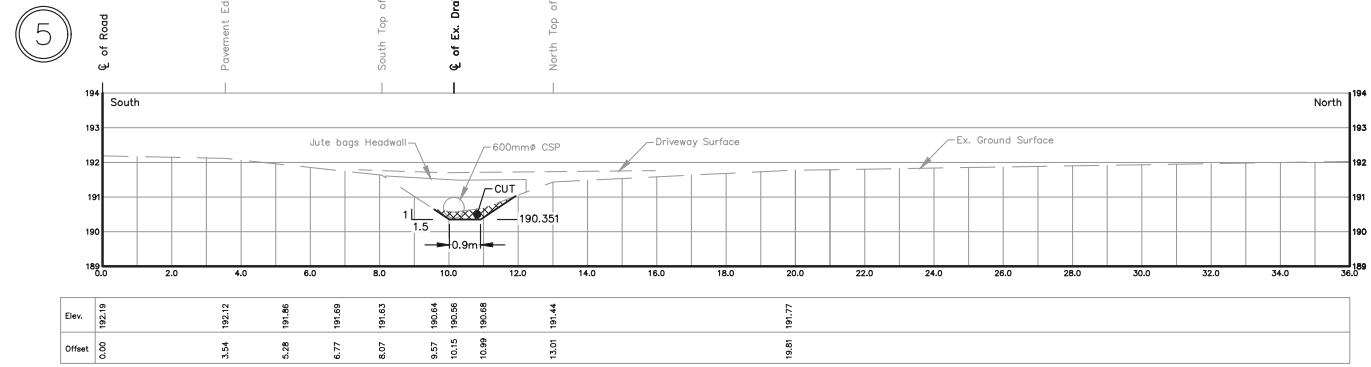

STA. 0+383.9
Scale = 1:100

THESE PLANS HAVE BEEN REDUCED AND THE SCALE THEREFORE VARIES. FULL SCALE PLANS MAY BE VIEWED AT THE MUNICIPAL OFFICE.

DRAWN BY: G.S. & S.H.
PLOT CODE: 1:1
COMPUTER FILE: REI20150010.DWG
FILE No.: SHEET No.:
2015D010 7 OF 51

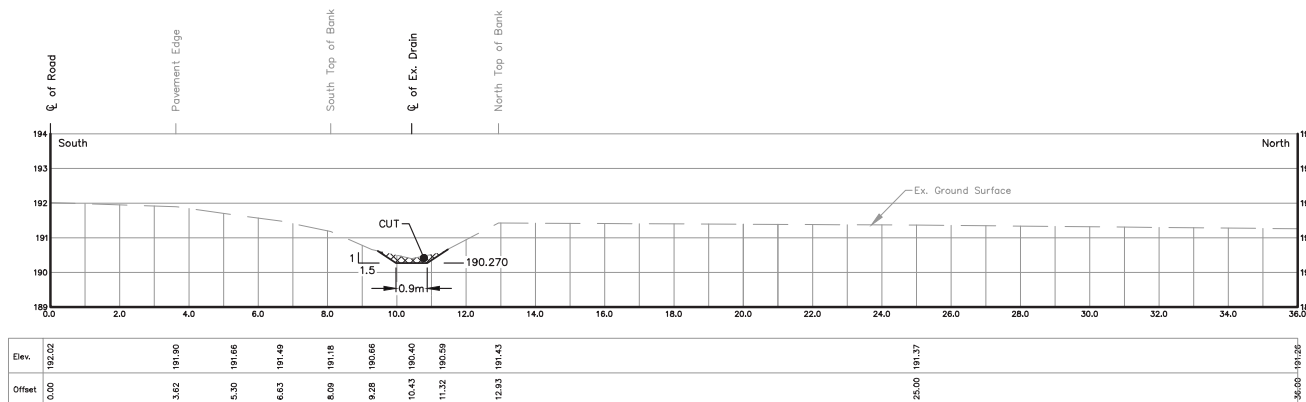

STA. 0+519.7
Scale = 1:100

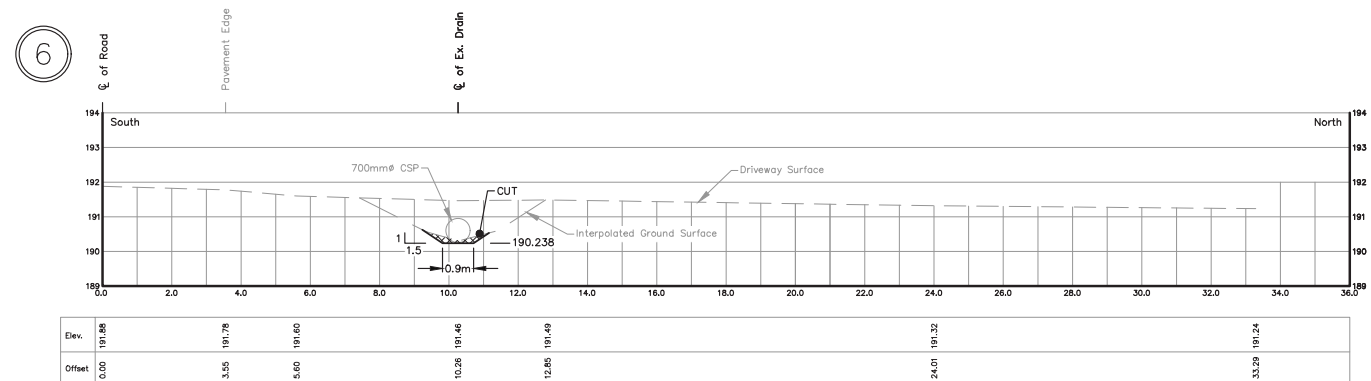

STA. 0+573.0
Scale = 1:100

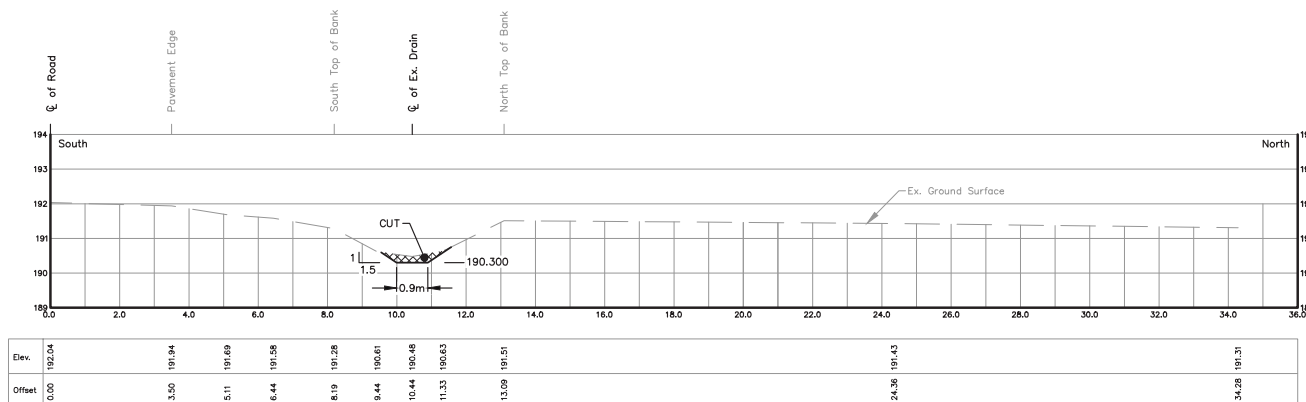

STA. 0+469.1
Scale = 1:100

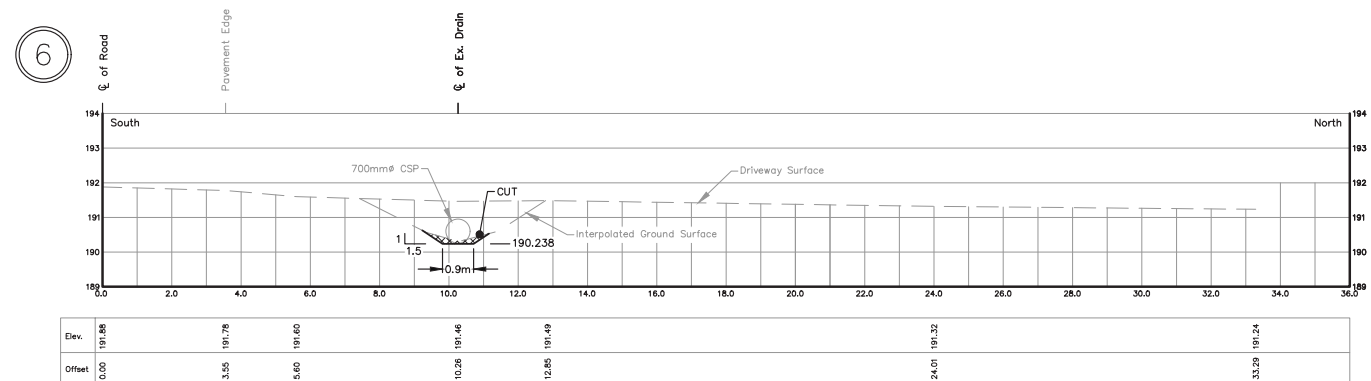

STA. 0+573.0
Scale = 1:100

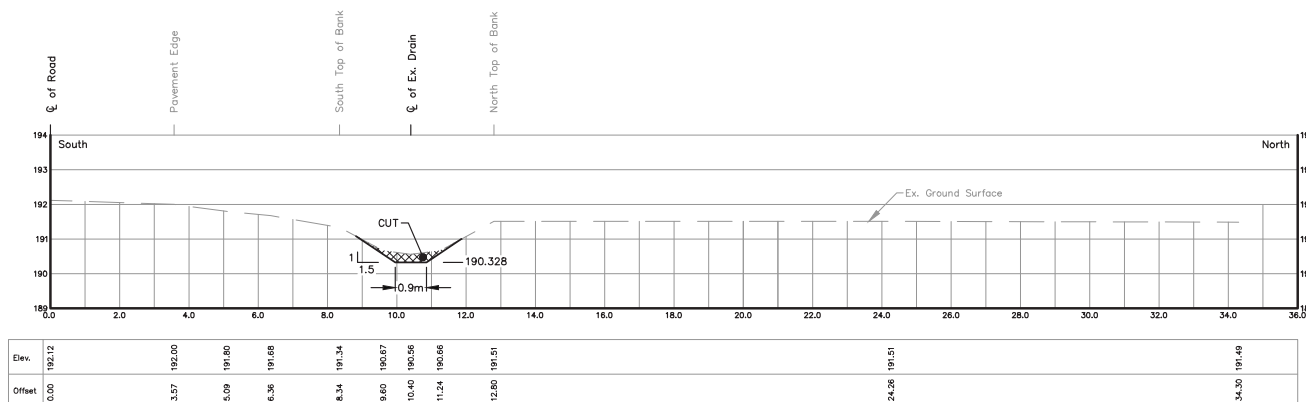

STA. 0+421.5
Scale = 1:100

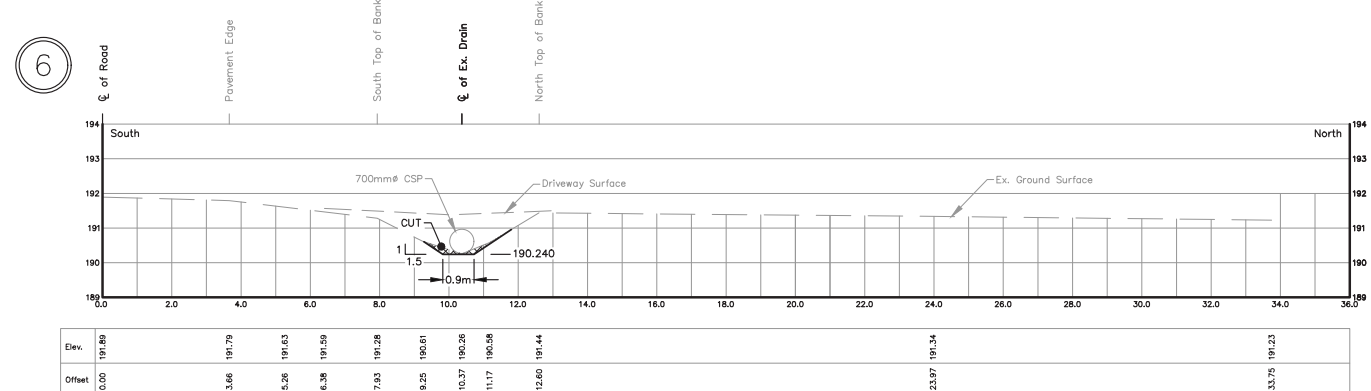

STA. 0+570.2
Scale = 1:100

THESE PLANS HAVE BEEN REDUCED AND THE SCALE THEREFORE VARIES. FULL SCALE PLANS MAY BE VIEWED AT THE MUNICIPAL OFFICE.

C:\Users\John\Desktop\REI-2015D010 - Sullivan Creek Drain\REI2015D010 - Sections.dwg 2021-05-16

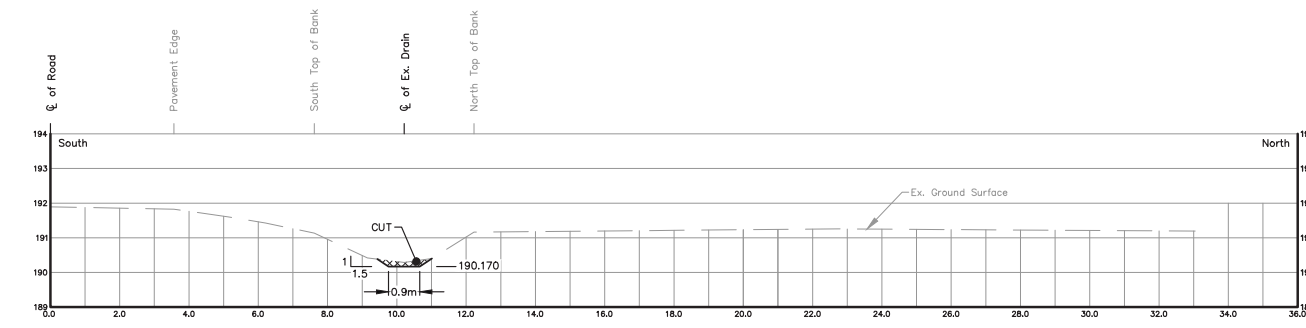

Elev.	191.89	191.83	191.81	191.43	191.14	190.42	190.29	190.40	191.16	191.26	191.19
Offset	0.00	3.56	5.13	6.21	7.62	9.15	10.21	11.01	12.23	22.75	33.04

STA. 0+687.4
Scale = 1:100

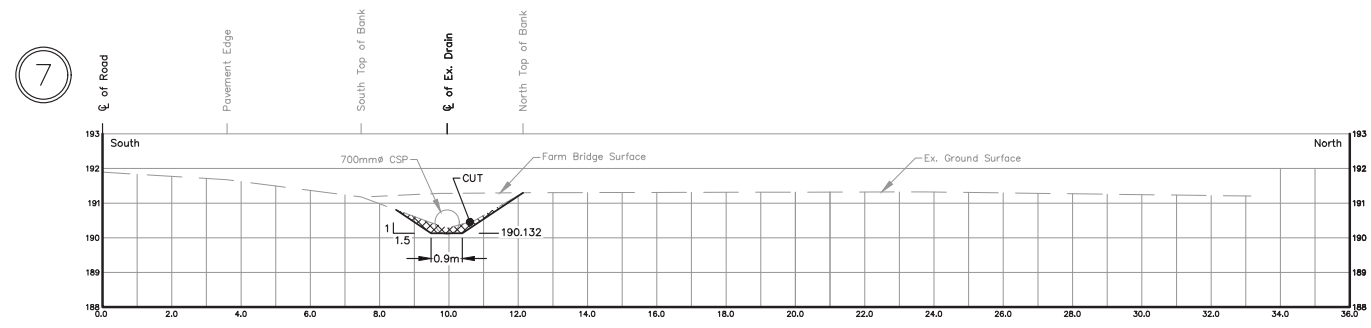

Elev.	191.95	191.68	191.50	191.36	191.18	190.46	190.28	190.49	191.30	191.33	191.21
Offset	0.00	3.59	5.25	6.25	7.47	9.41	10.28	10.72	12.14	23.72	33.15

STA. 0+747.6
Scale = 1:100

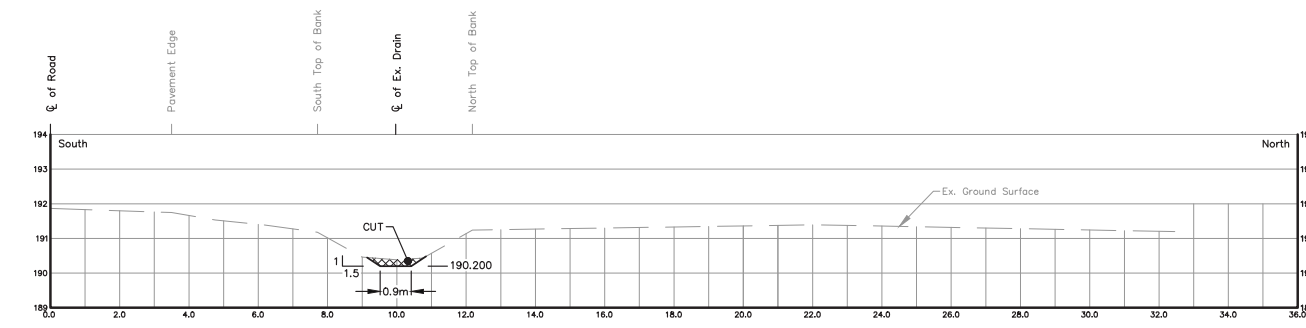

Elev.	191.87	191.75	191.53	191.39	191.18	190.46	190.39	190.43	191.24	191.39	191.20
Offset	0.00	3.50	4.76	6.16	7.71	8.89	9.87	10.76	12.18	22.15	32.45

STA. 0+638.0
Scale = 1:100

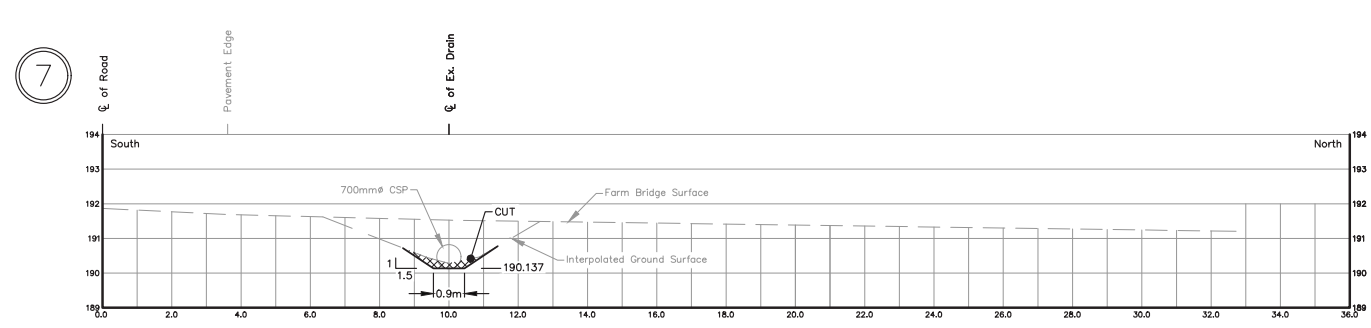

Elev.	191.87	191.89	191.61	191.33	191.33	190.46	190.33	191.21	191.33	191.33	191.21
Offset	0.00	3.61	5.39	10.00	10.00	10.00	10.00	32.72	32.72	32.72	32.72

STA. 0+742.5
Scale = 1:100

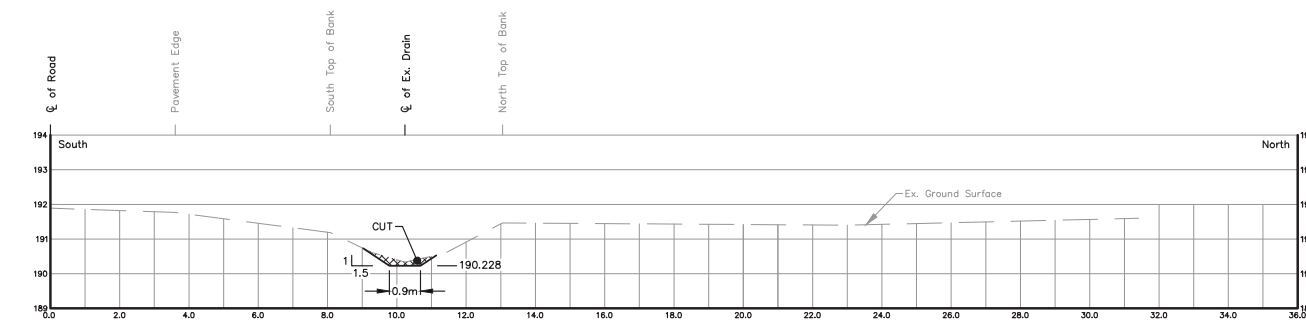

Elev.	191.86	191.19	191.57	191.41	191.57	190.61	190.34	190.56	191.47	191.40	191.60
Offset	0.00	3.60	5.15	6.38	8.08	9.27	10.23	11.37	13.05	22.89	31.41

STA. 0+589.7
Scale = 1:100

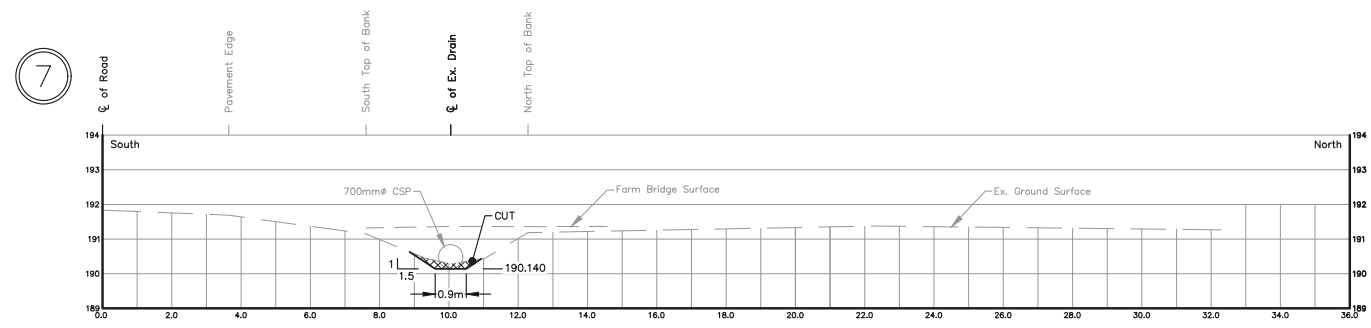

Elev.	191.84	191.68	191.52	191.15	190.45	190.28	190.45	191.19	191.38	191.27
Offset	0.00	3.65	5.28	7.61	9.30	10.05	11.04	12.28	22.33	32.29

STA. 0+737.3
Scale = 1:100

THESE PLANS HAVE BEEN REDUCED
AND THE SCALE THEREFORE VARIES.
FULL SCALE PLANS MAY BE VIEWED
AT THE MUNICIPAL OFFICE.

DRAWN BY: G.S. & S.H.
PLOT CODE: 1:1
COMPUTER FILE: REI2015D010.DWG
FILE No.: SHEET No.:
2015D010 9 OF 51

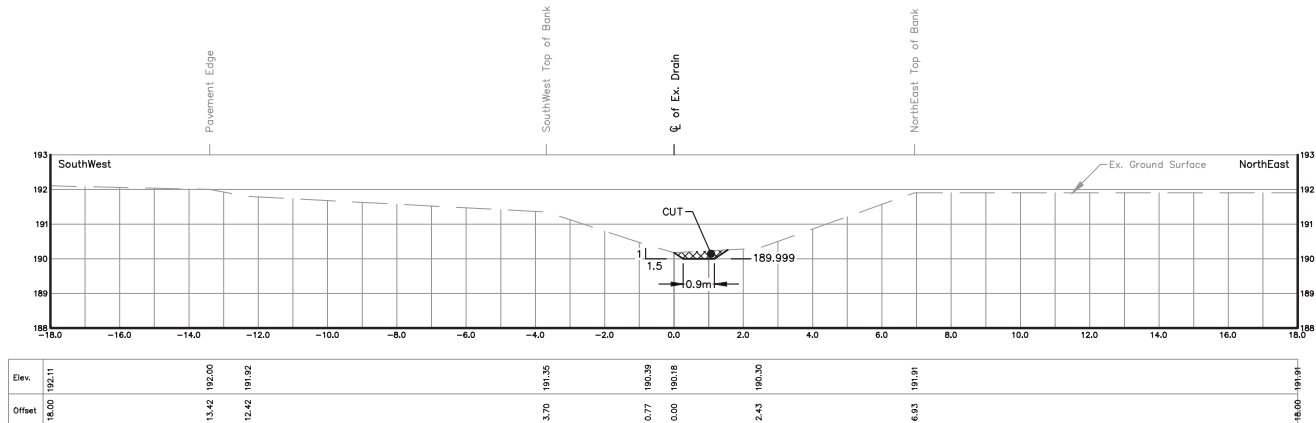

STA. 0+879.5
Scale = 1:100

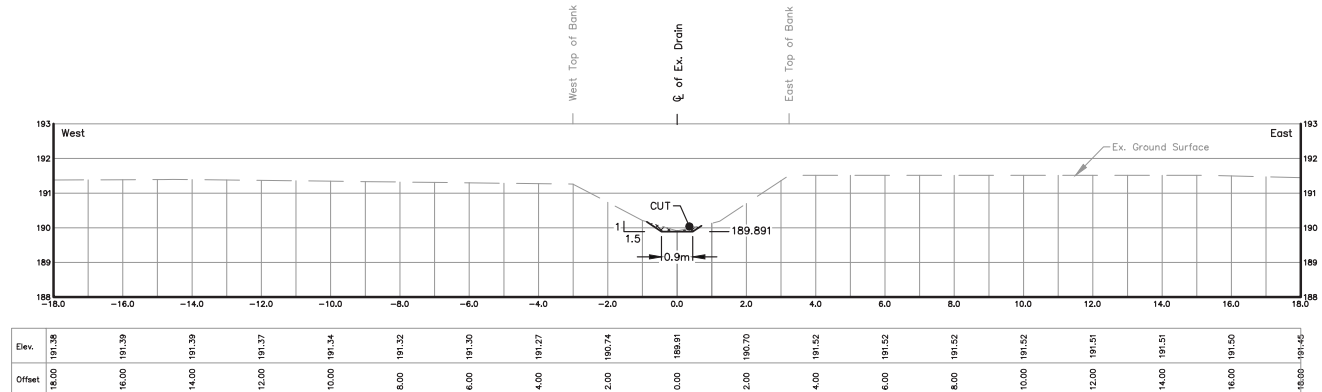

STA. 0+986.7
Scale = 1:100

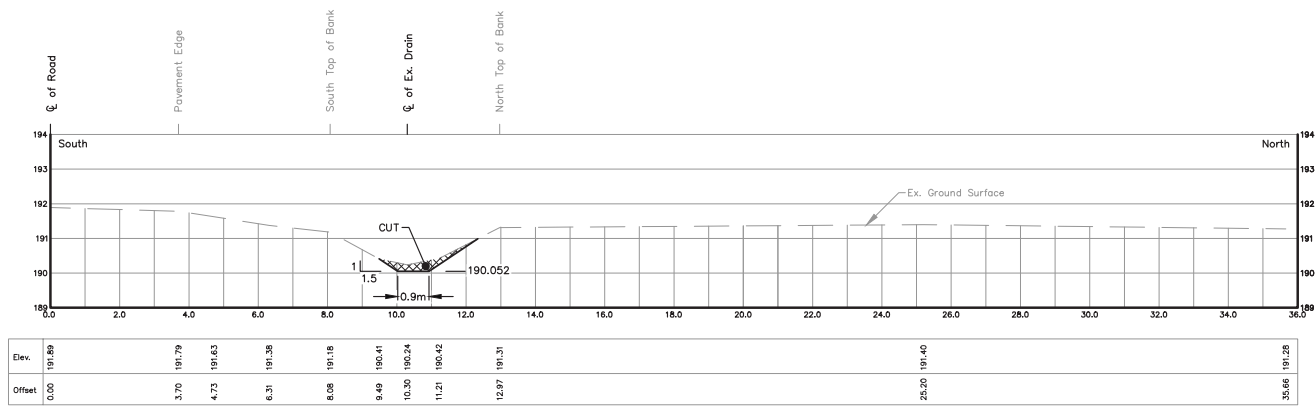

STA. 0+826.7
Scale = 1:100

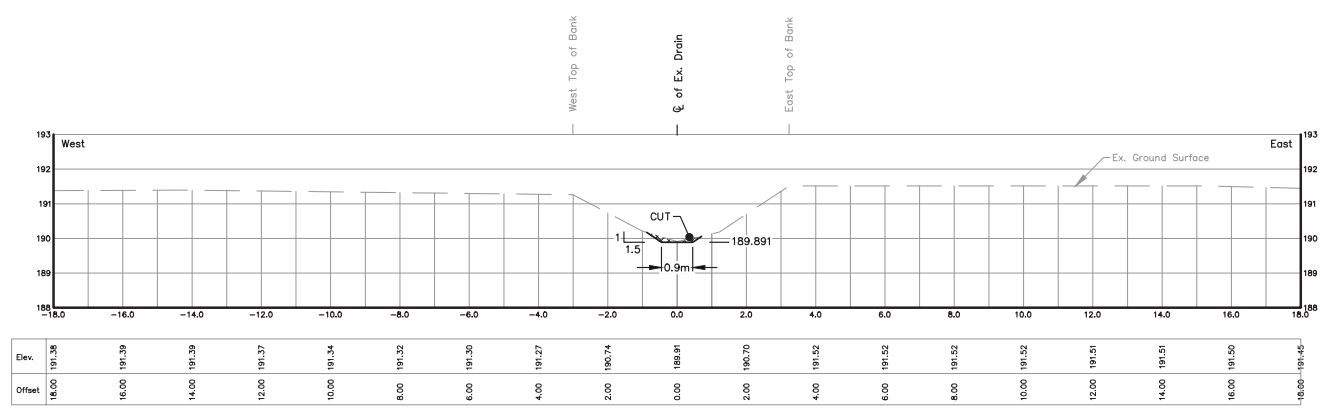

STA. 0+986.7
Scale = 1:100

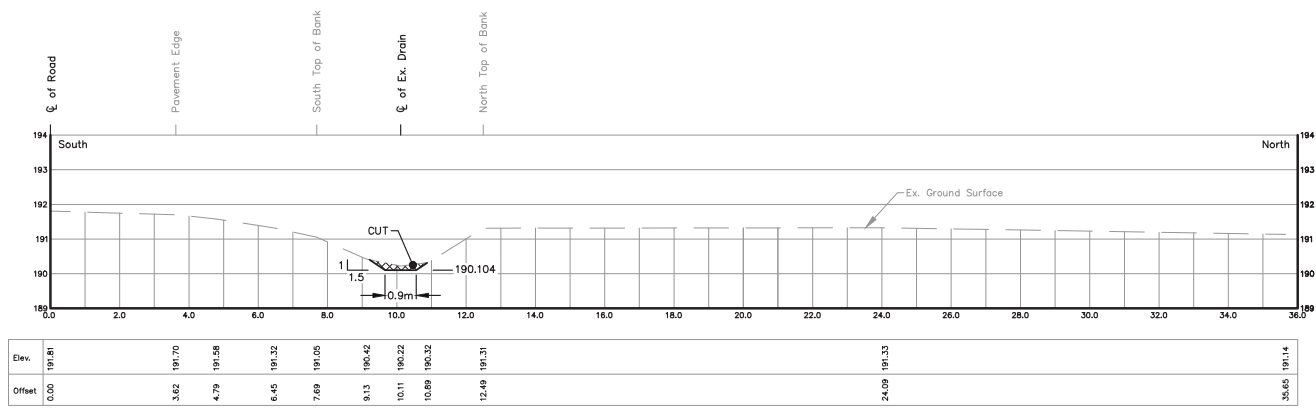

STA. 0+775.8
Scale = 1:100

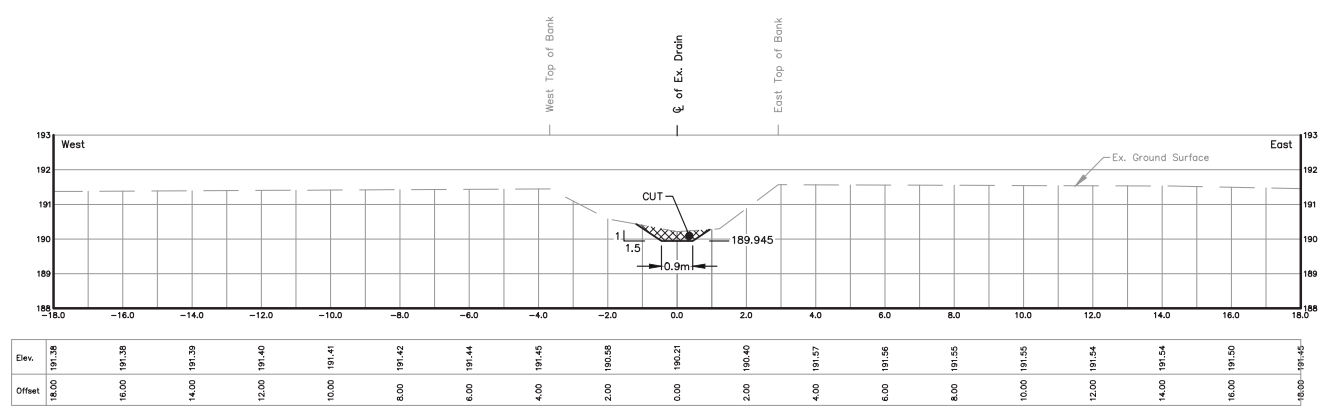

STA. 0+933.0
Scale = 1:100

THESE PLANS HAVE BEEN REDUCED AND THE SCALE THEREFORE VARIES. FULL SCALE PLANS MAY BE VIEWED AT THE MUNICIPAL OFFICE.

C:\Users\John\Desktop\REI-2015D010 - Sullivan Creek Drain\REI2015D010 - Sections.dwg 2021-05-16

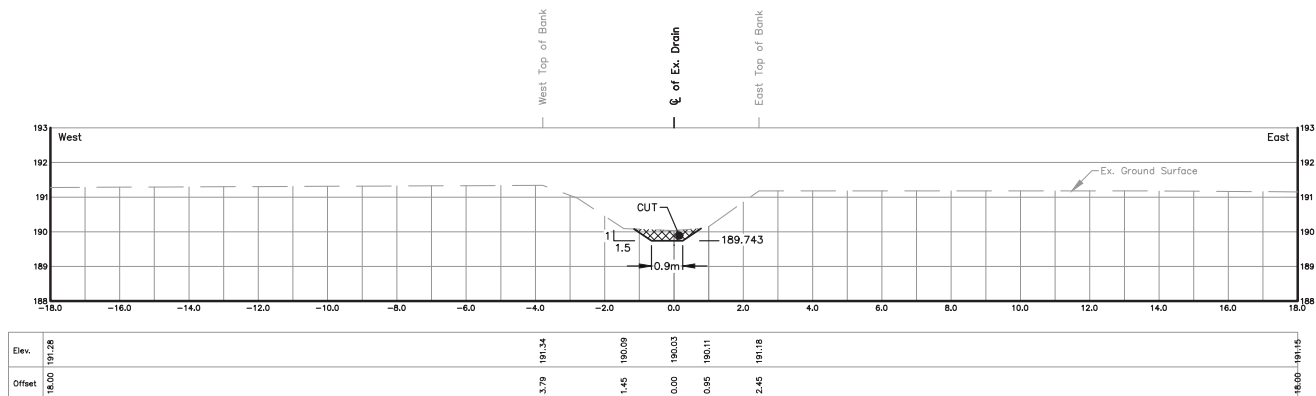

STA. 1+132.7
Scale = 1:100

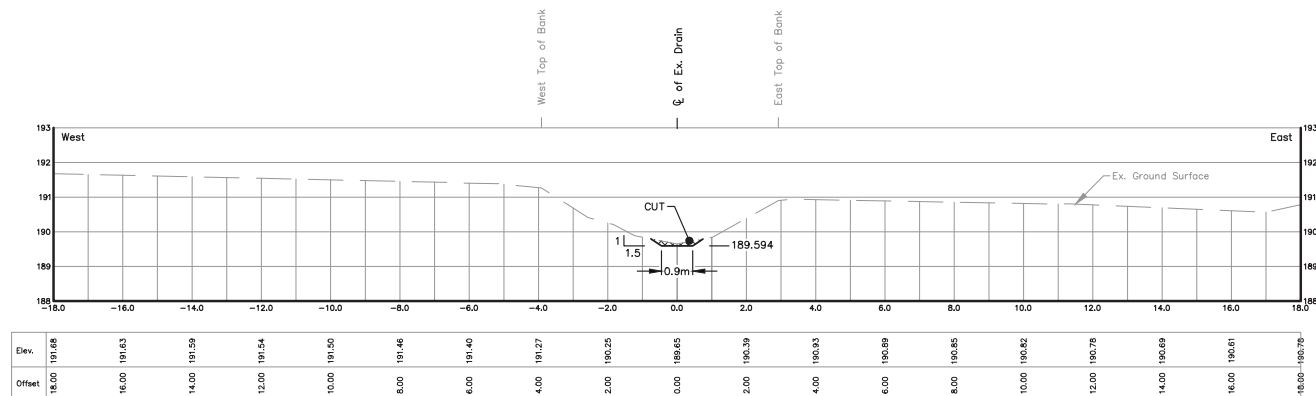

STA. 1+280.7
Scale = 1:100

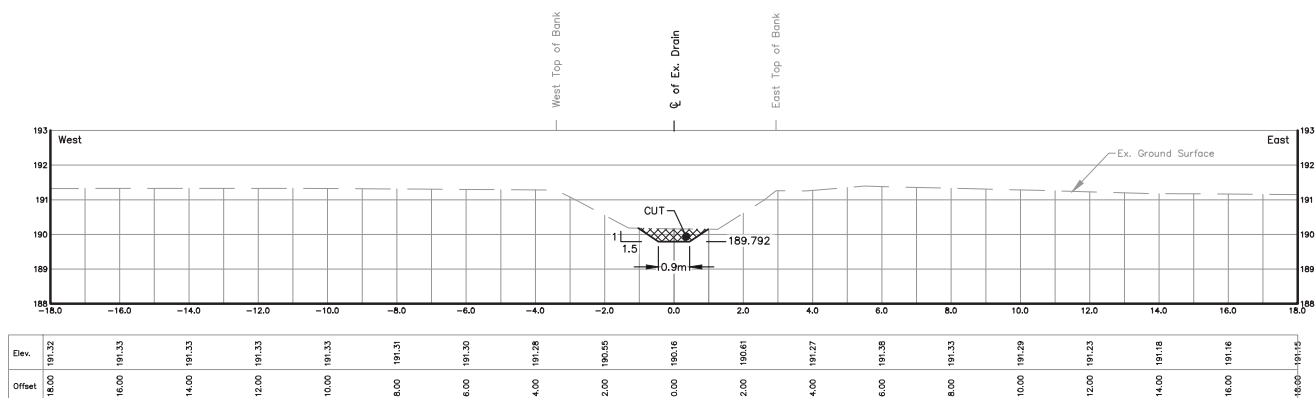

STA. 1+089
Scale = 1:100

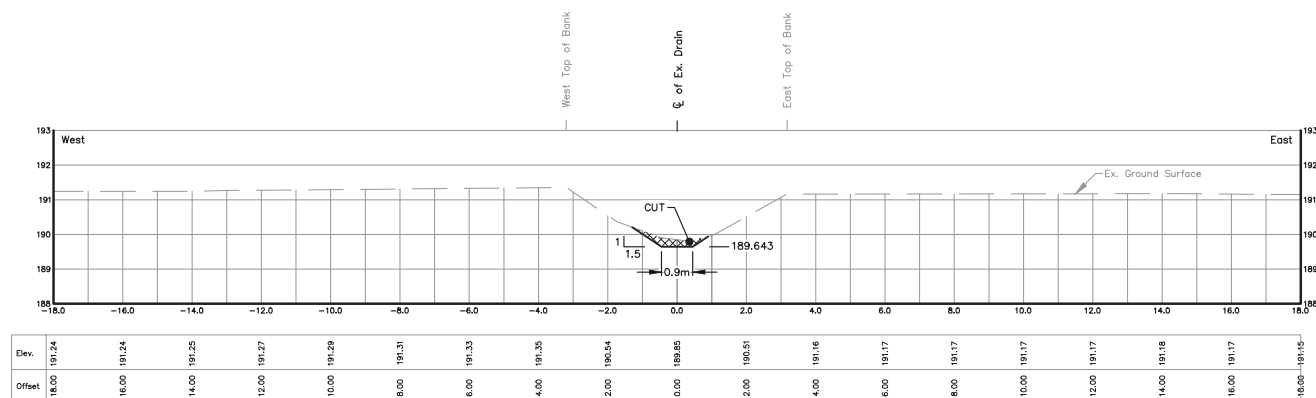

STA. 1+231.4
Scale = 1:100

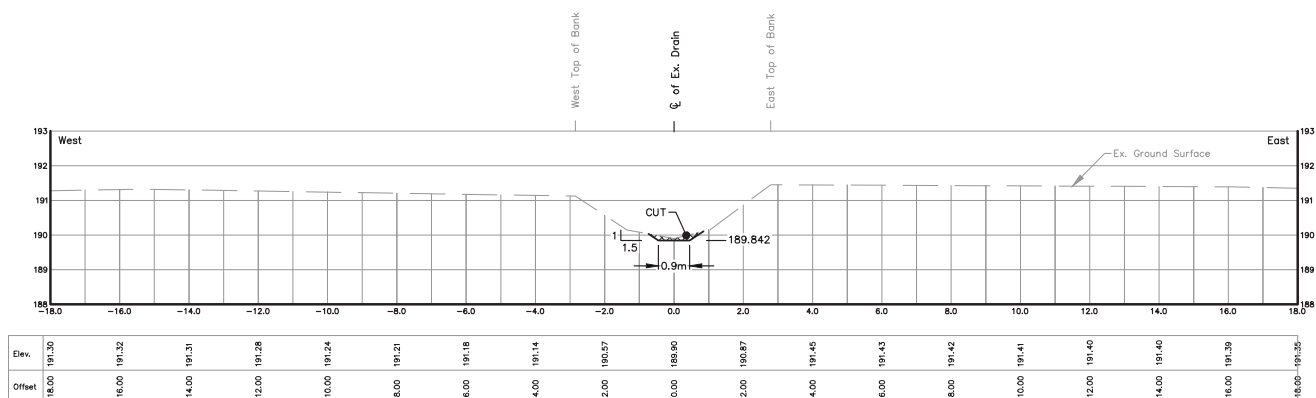

STA. 1+034.4
Scale = 1:100

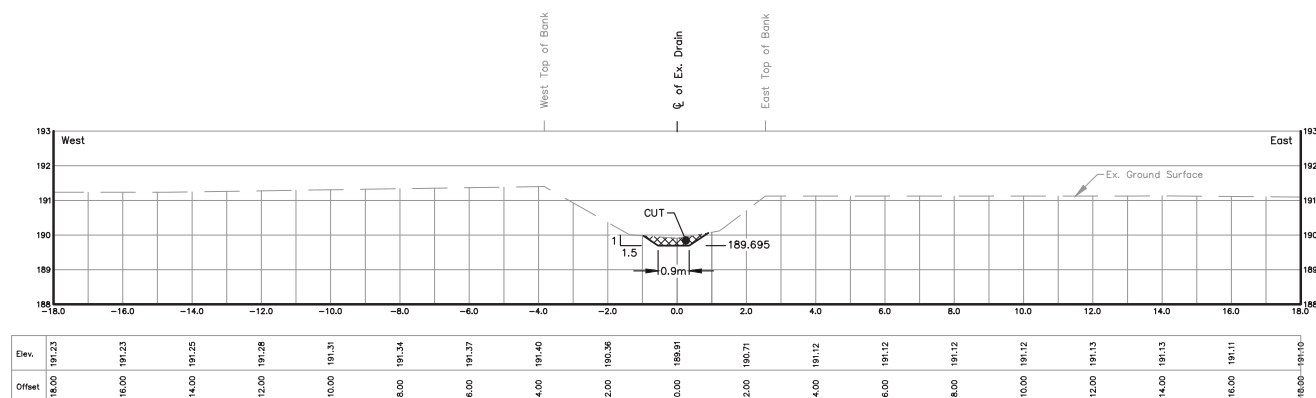

STA. 1+180.0
Scale = 1:100

THESE PLANS HAVE BEEN REDUCED AND THE SCALE THEREFORE VARIES FULL SCALE PLANS MAY BE VIEWED AT THE MUNICIPAL OFFICE.

DRAWN BY: G.S. & S.H.
PLOT CODE: 1:1
COMPUTER FILE: REI2015D010.DWG
FILE No.: SHEET No.:
2015D010 11 OF 51

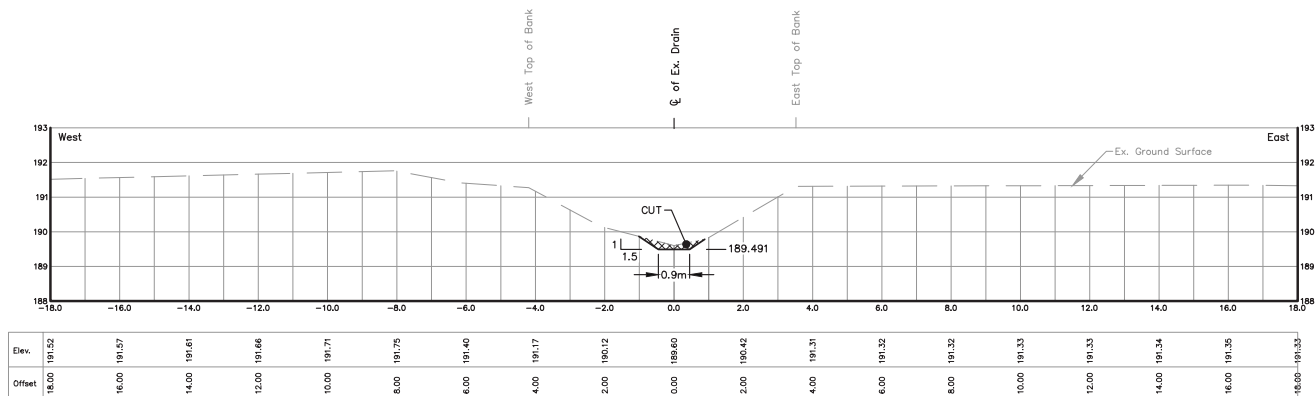

STA. 1+381.0
Scale = 1:100

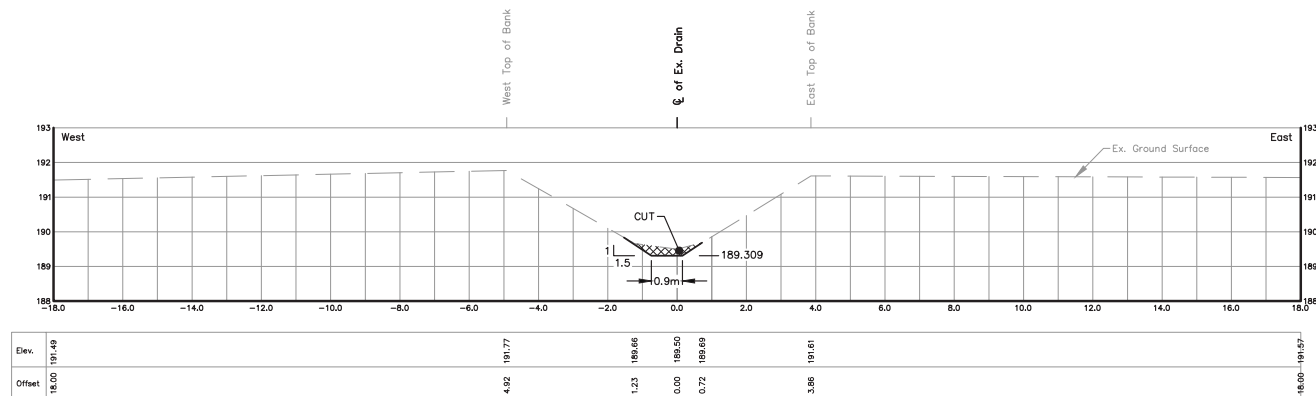

STA. 1+561.2
Scale = 1:100

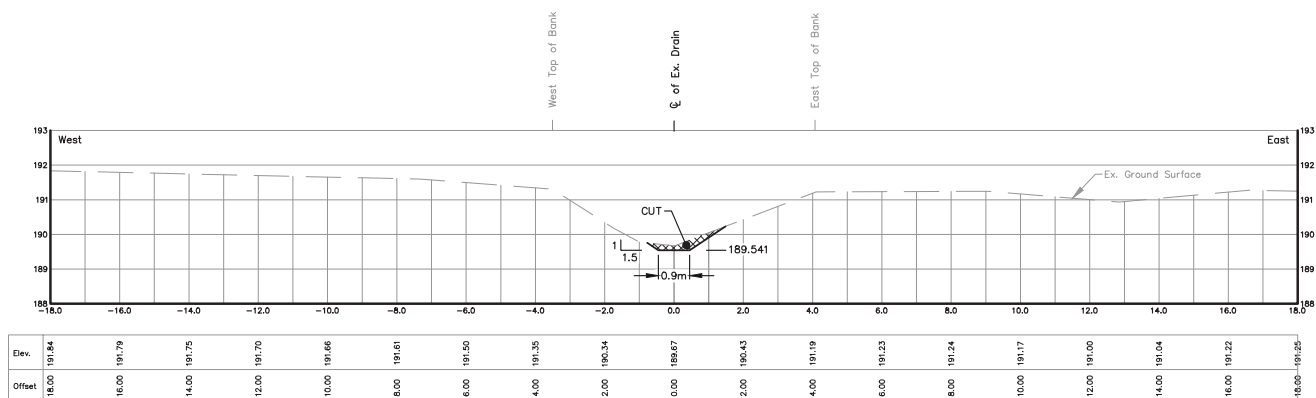

STA. 1+332.2
Scale = 1:100

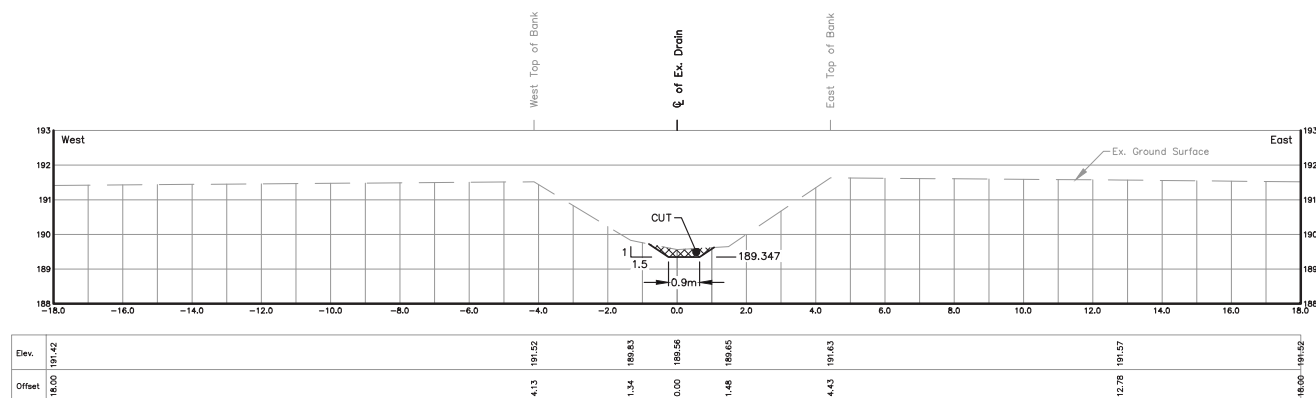

STA. 1+524.1
Scale = 1:100

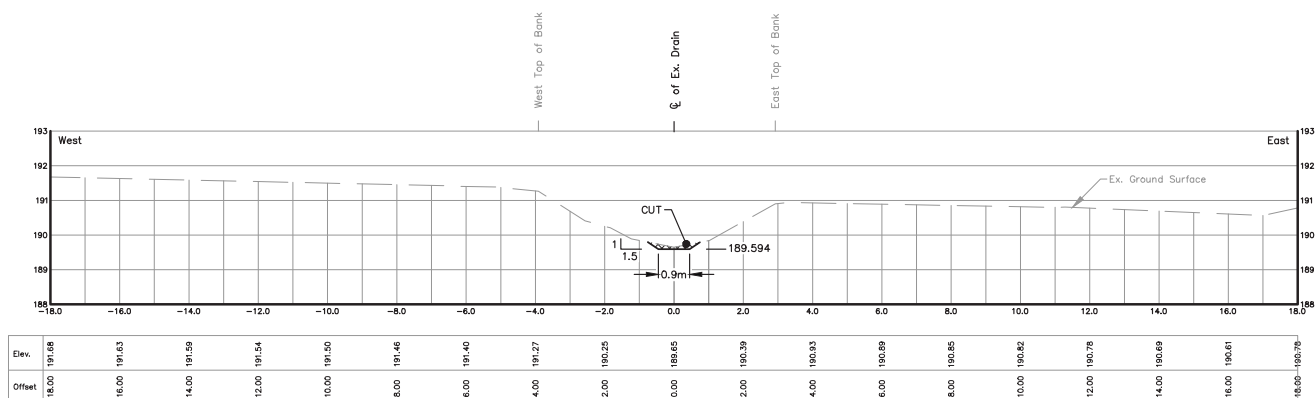

STA. 1+280.7
Scale = 1:100

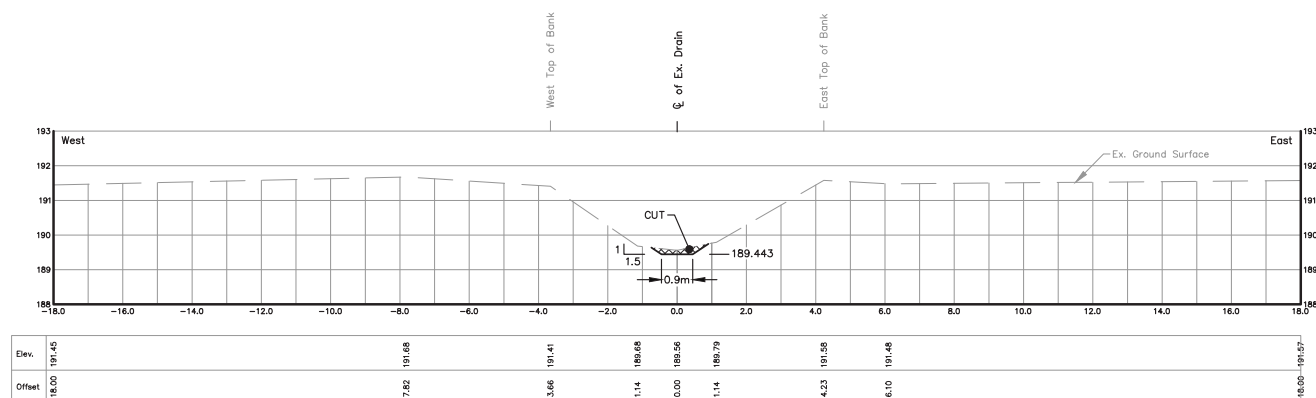

STA. 1+428.8
Scale = 1:100

THESE PLANS HAVE BEEN REDUCED AND THE SCALE THEREFORE VARIES. FULL SCALE PLANS MAY BE VIEWED AT THE MUNICIPAL OFFICE.

DRAWN BY: G.S. & S.H.
PLOT CODE: 1:1
COMPUTER FILE: REI2015D010.DWG
FILE No.: SHEET No.:
2015D010 12 OF 51

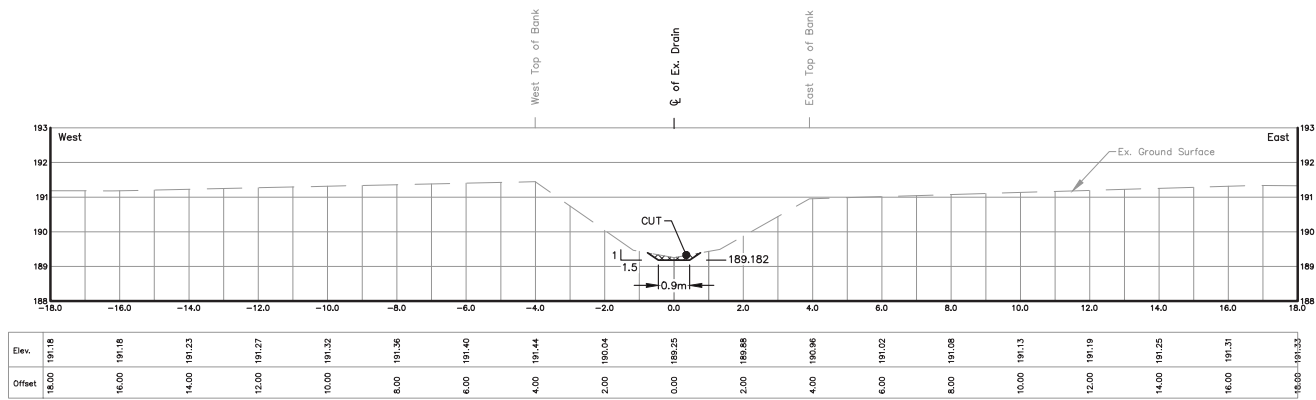

STA. 1+687.0
Scale = 1:100

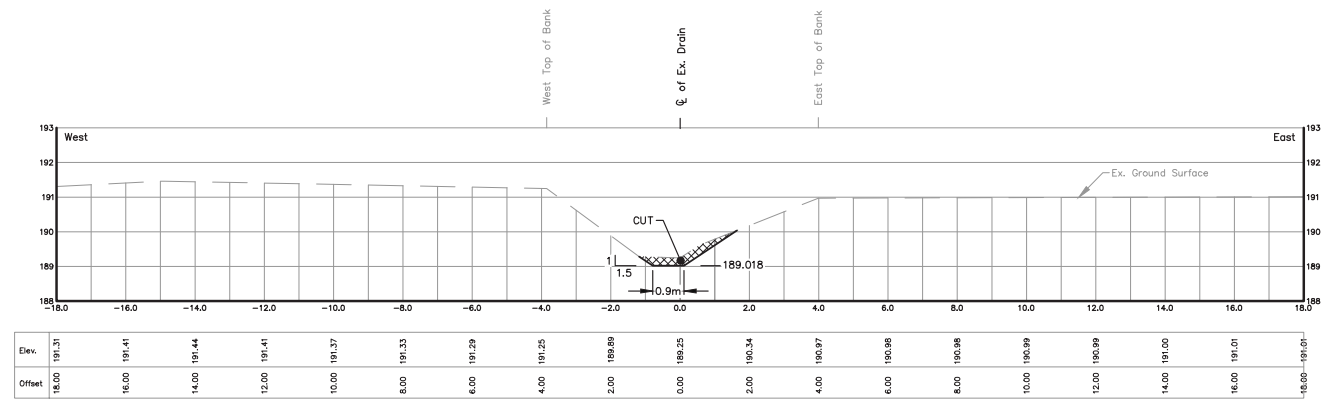

STA. 1+848.7
Scale = 1:100

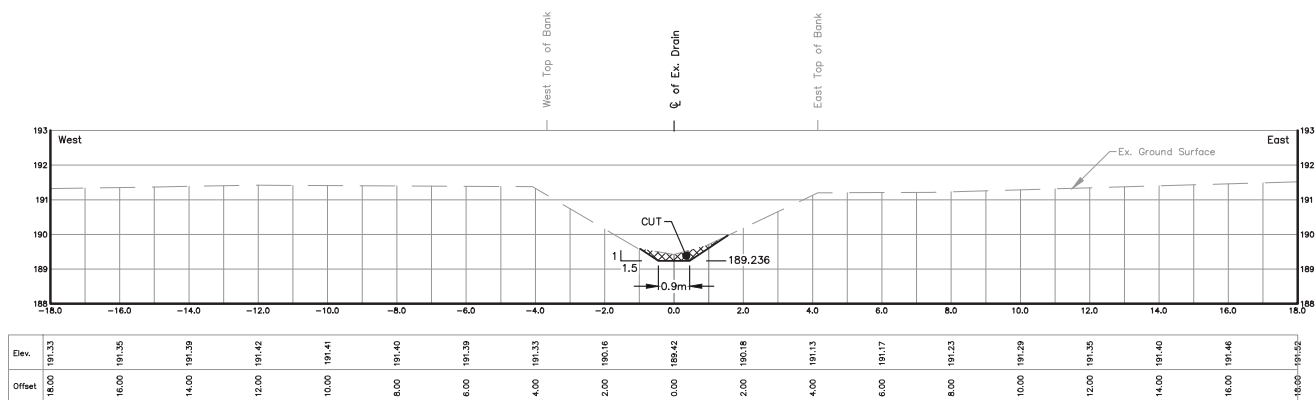

STA. 1+633.3
Scale = 1:100

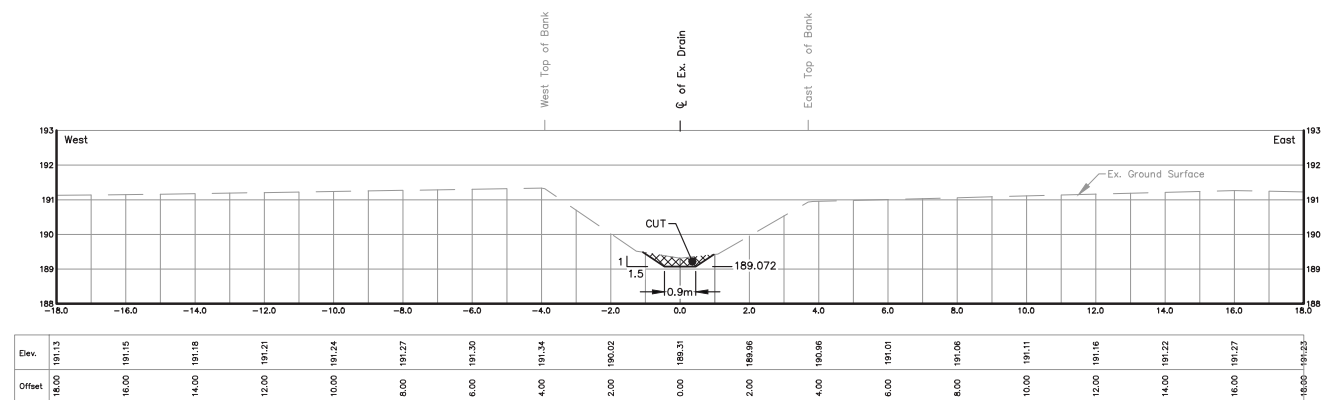

STA. 1+795.7
Scale = 1:100

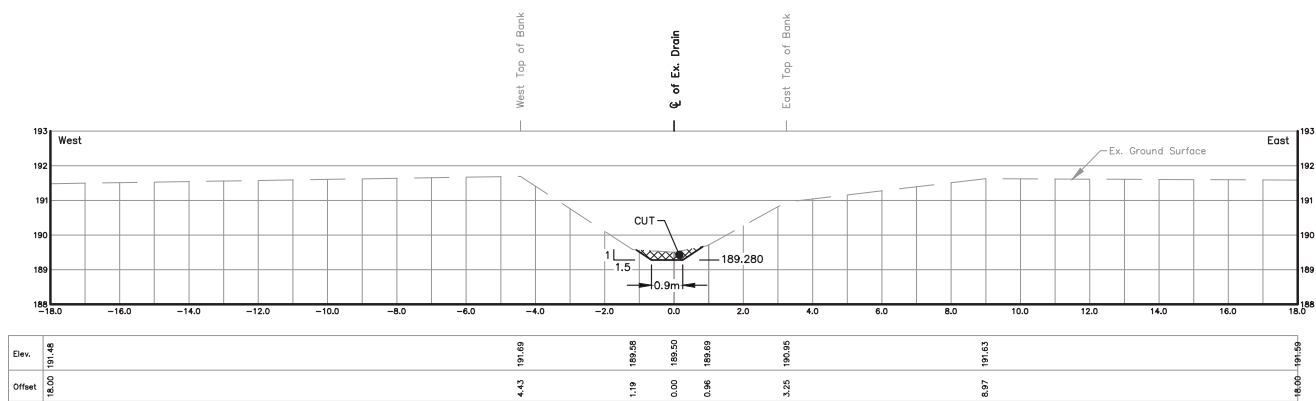

STA. 1+589.8
Scale = 1:100

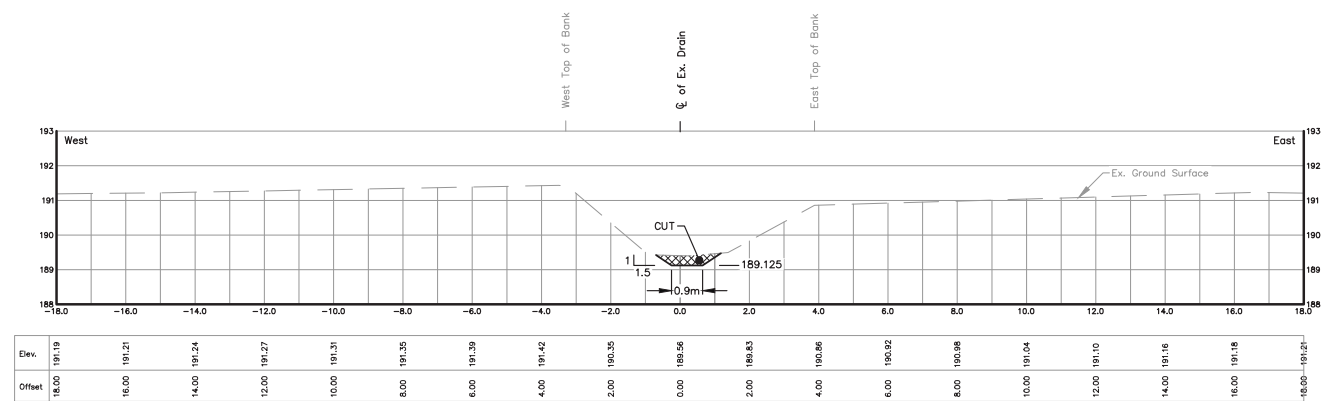

STA. 1+743.2
Scale = 1:100

THESE PLANS HAVE BEEN REDUCED
AND THE SCALE THEREFORE VARIES.
FULL SCALE PLANS MAY BE VIEWED
AT THE MUNICIPAL OFFICE.

DRAWN BY: G.S. & S.H.
PLOT CODE: 1:1
COMPUTER FILE: REI2015D010.DWG
FILE No.: SHEET No.:
2015D010 13 OF 51

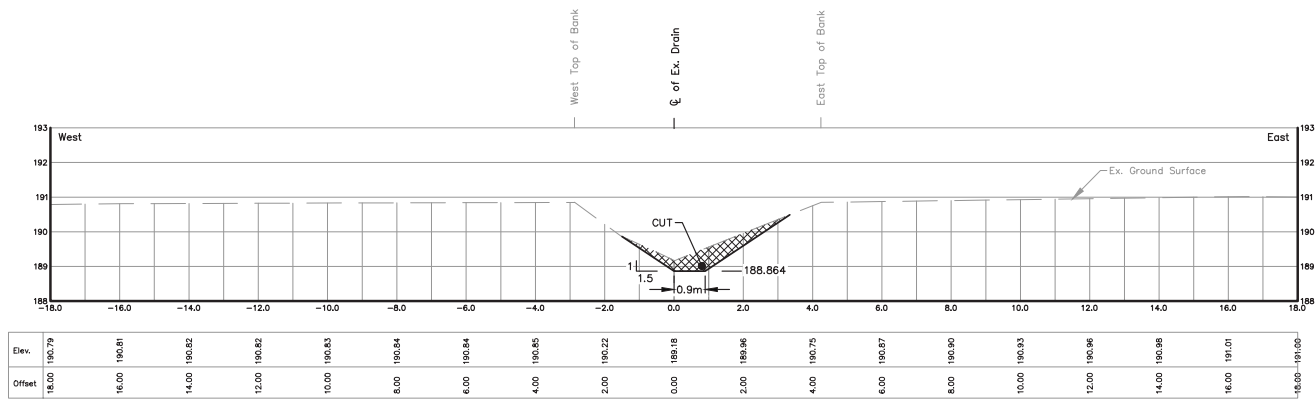

STA. 2+001.1
Scale = 1:100

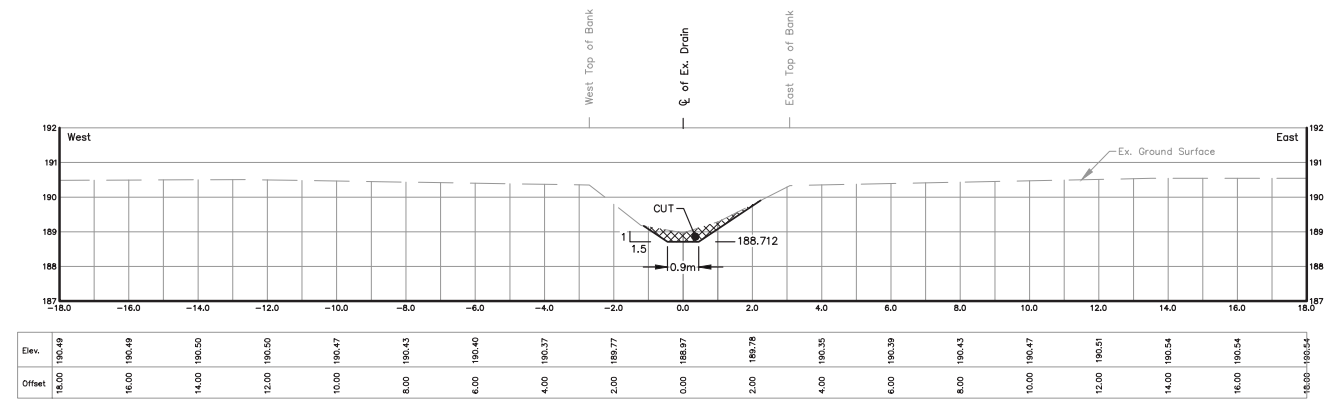

STA. 2+151.2
Scale = 1:100

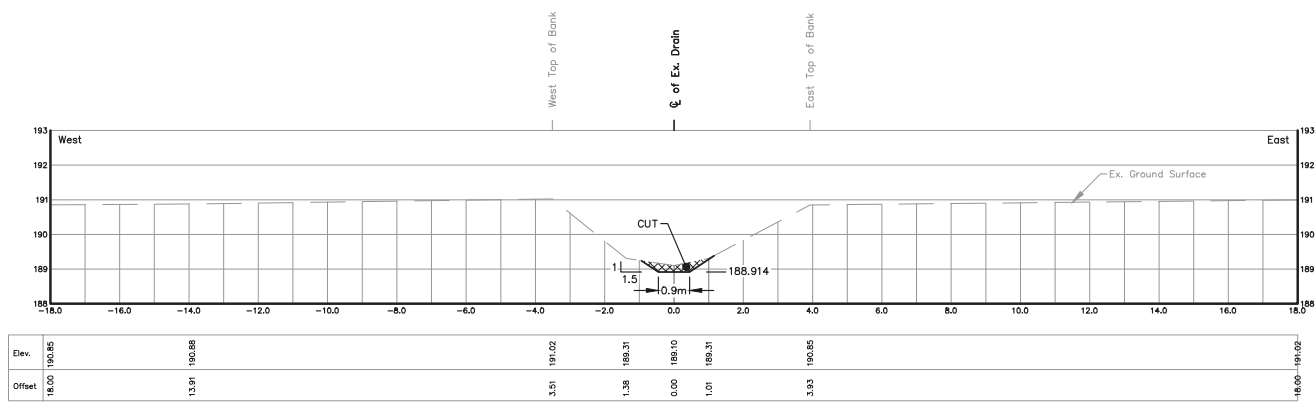

STA. 1+952.0
Scale = 1:100

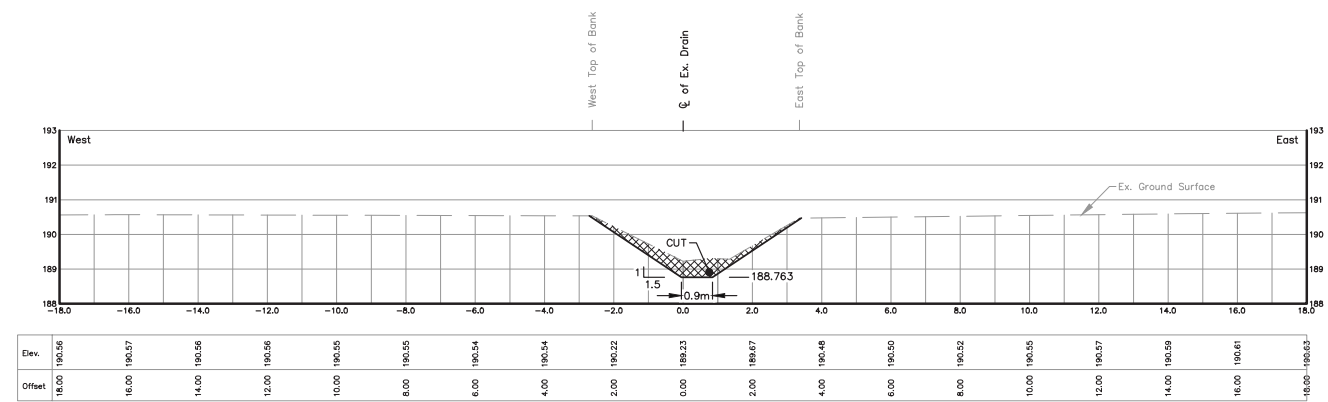

STA. 2+100.5
Scale = 1:100

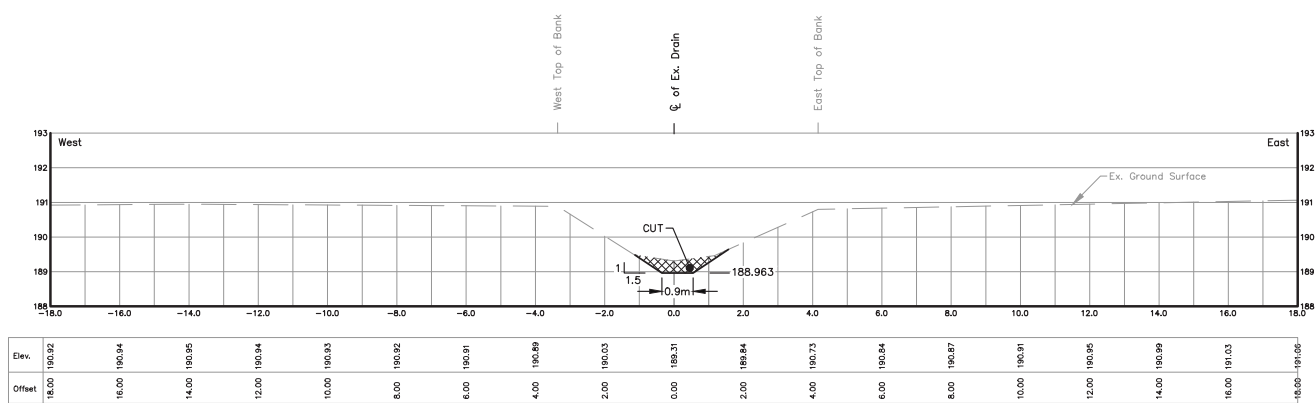

STA. 1+903.2
Scale = 1:100

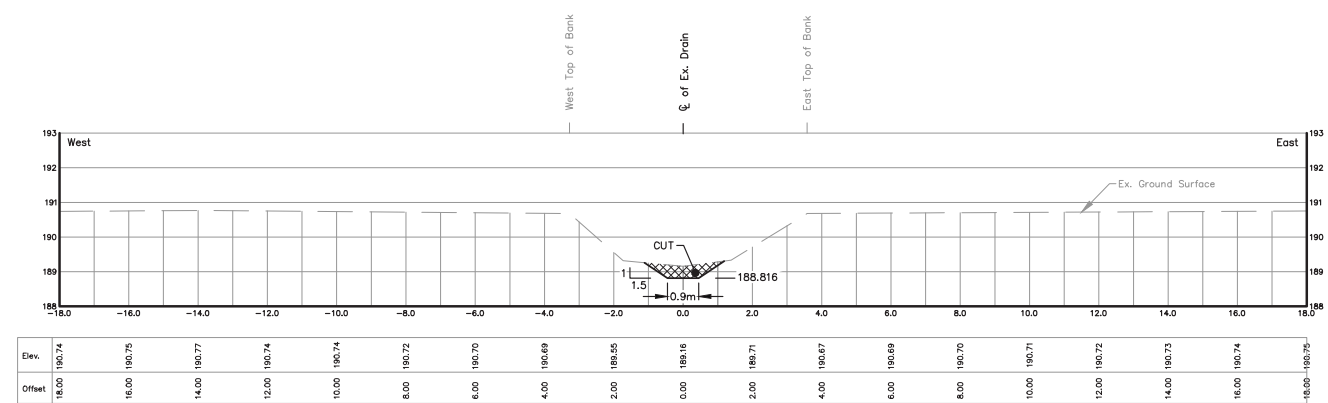

STA. 2+048.8
Scale = 1:100

THESE PLANS HAVE BEEN REDUCED AND THE SCALE THEREFORE VARIES. FULL SCALE PLANS MAY BE VIEWED AT THE MUNICIPAL OFFICE.

DRAWN BY: G.S. & S.H.
PLOT CODE: 1:1
COMPUTER FILE: REI2015D010.DWG
FILE No.: SHEET No.:
2015D010 14 OF 51

8

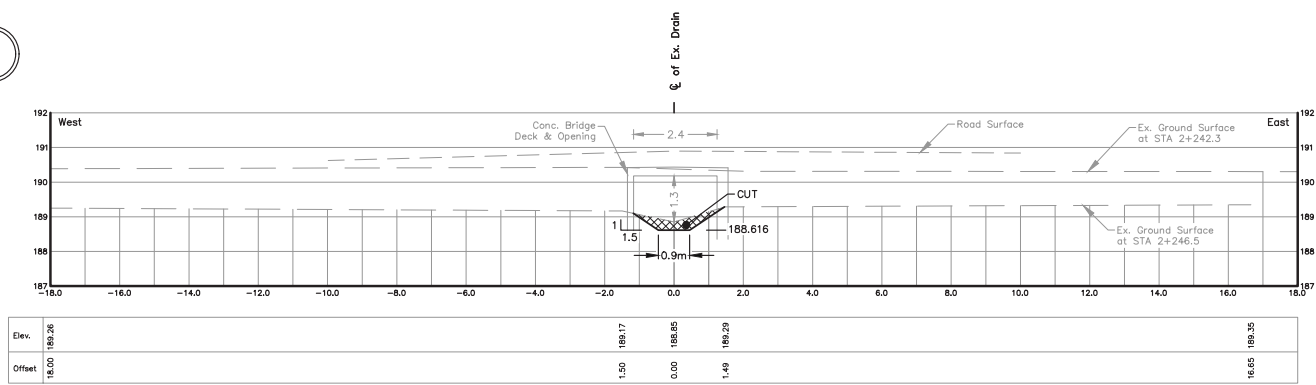

STA. 2+246.5
Scale = 1:100

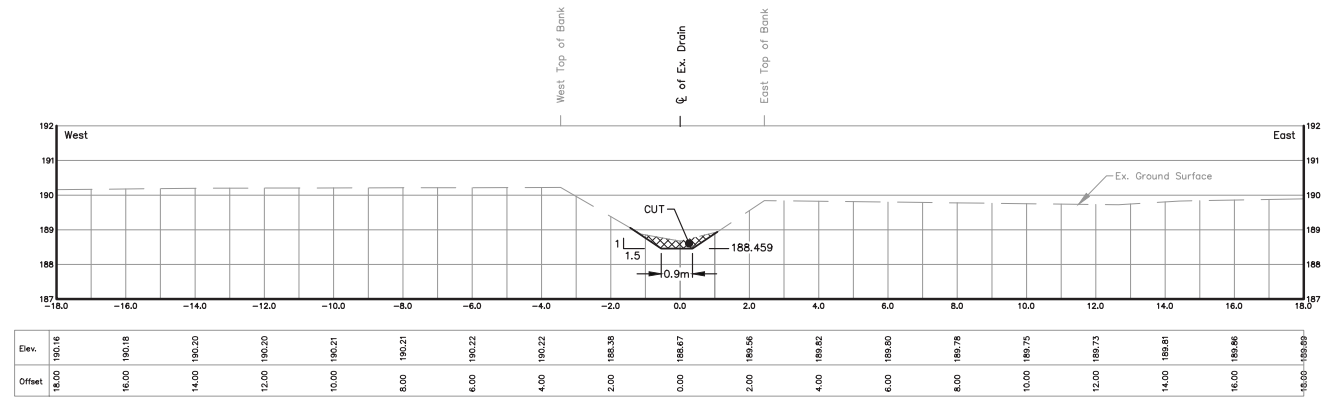

STA. 2+401.4
Scale = 1:100

8

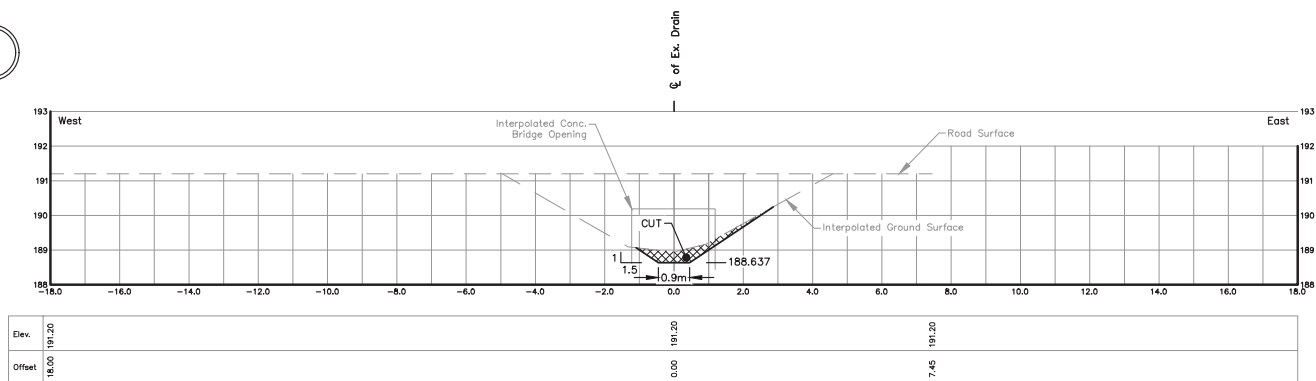

STA. 2+225.2
Scale = 1:100

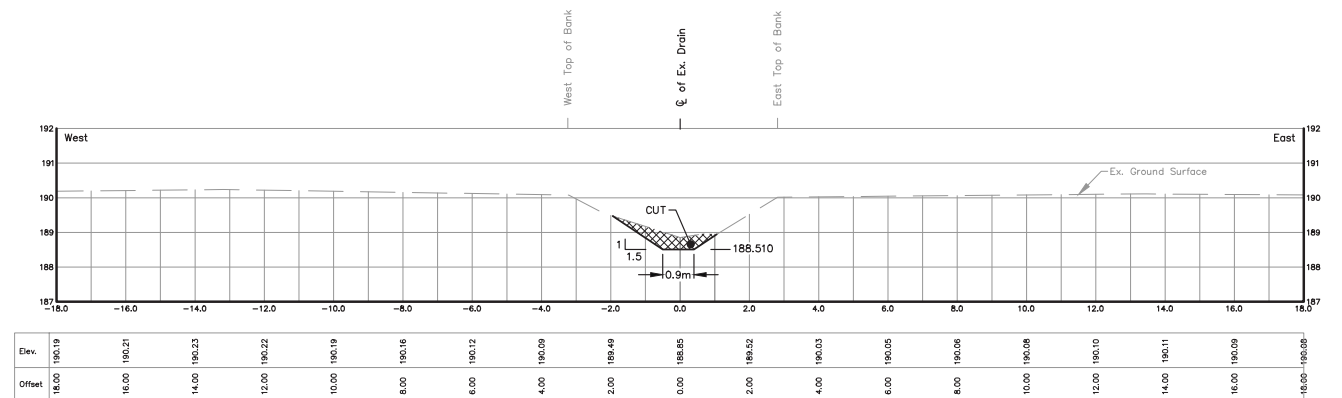

STA. 2+350.4
Scale = 1:100

8

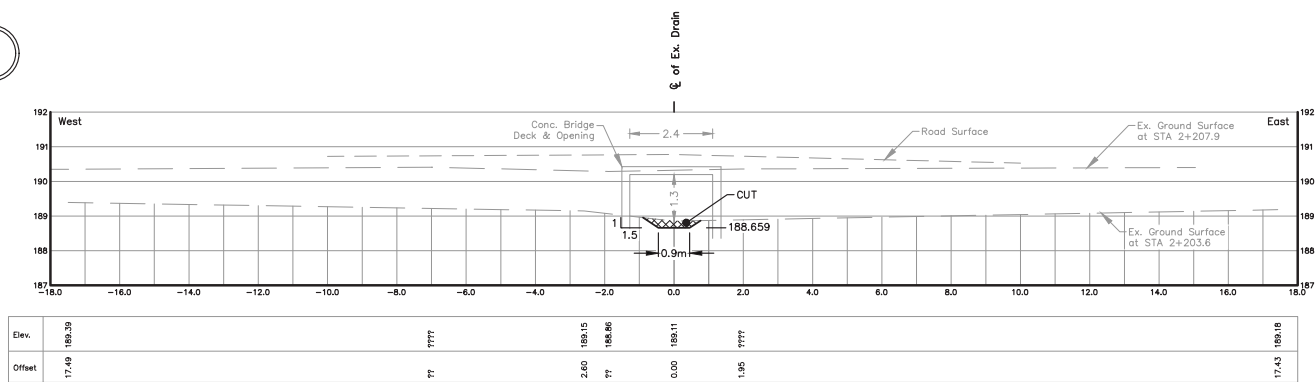

STA. 2+203.6
Scale = 1:100

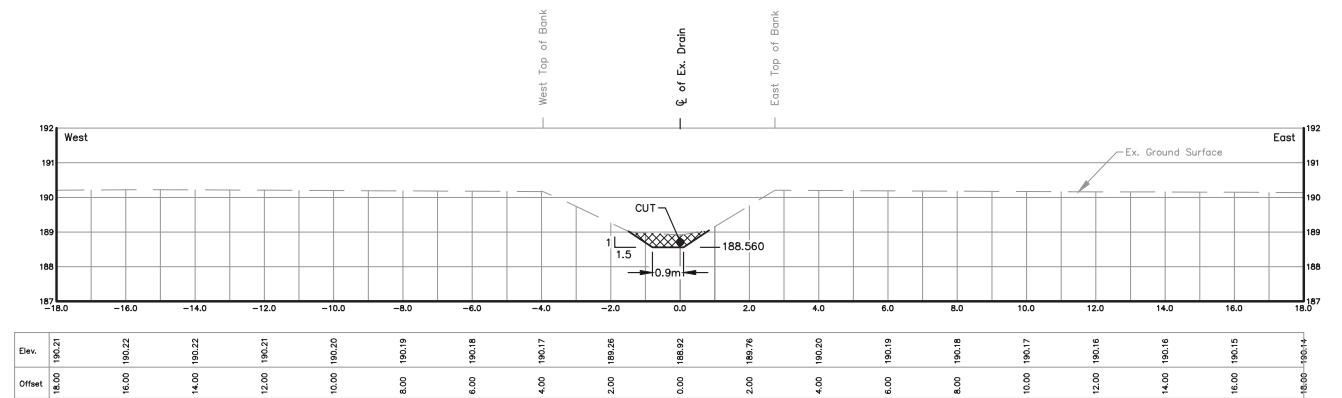

STA. 2+301.9
Scale = 1:100

THESE PLANS HAVE BEEN REDUCED AND THE SCALE THEREFORE VARIES. FULL SCALE PLANS MAY BE VIEWED AT THE MUNICIPAL OFFICE.

DRAWN BY: G.S. & S.H.
PLOT CODE: 1:1
COMPUTER FILE: REI2015D010.DWG
FILE No.: SHEET No.:
2015D010 15 OF 51

C:\Users\John\Desktop\REI-2015D010 - Sullivan Creek Drain\REI2015D010 - Sections.dwg 2021-05-16

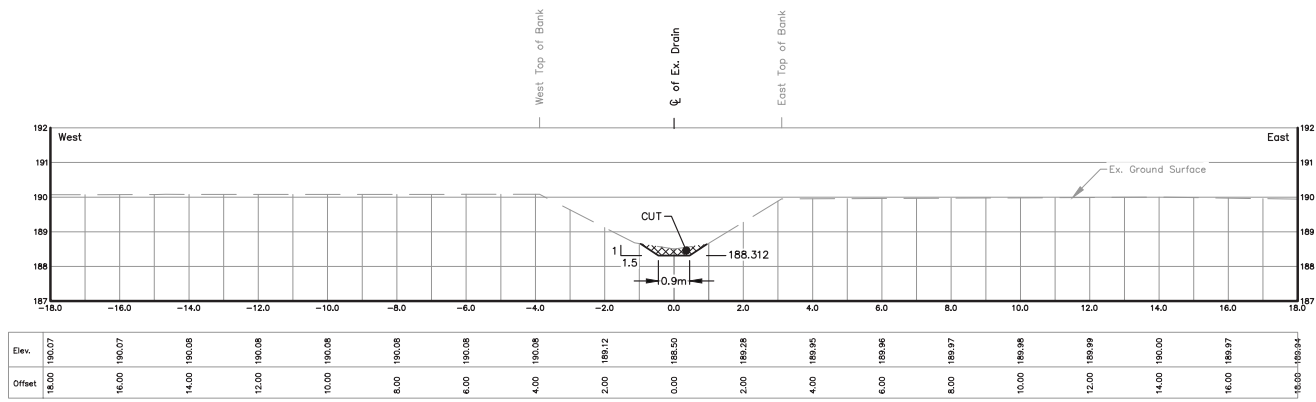

STA. 2+546.8
Scale = 1:100

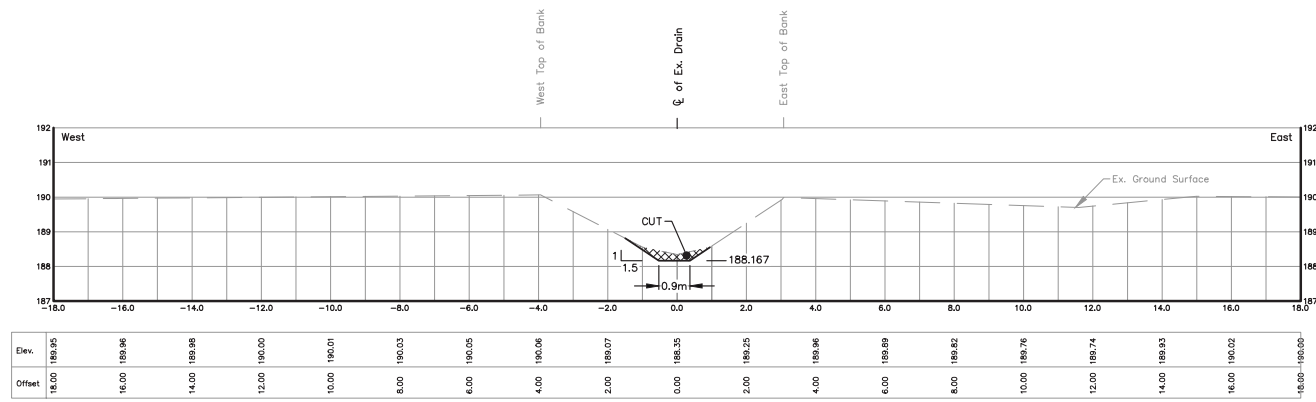

STA. 2+689.6
Scale = 1:100

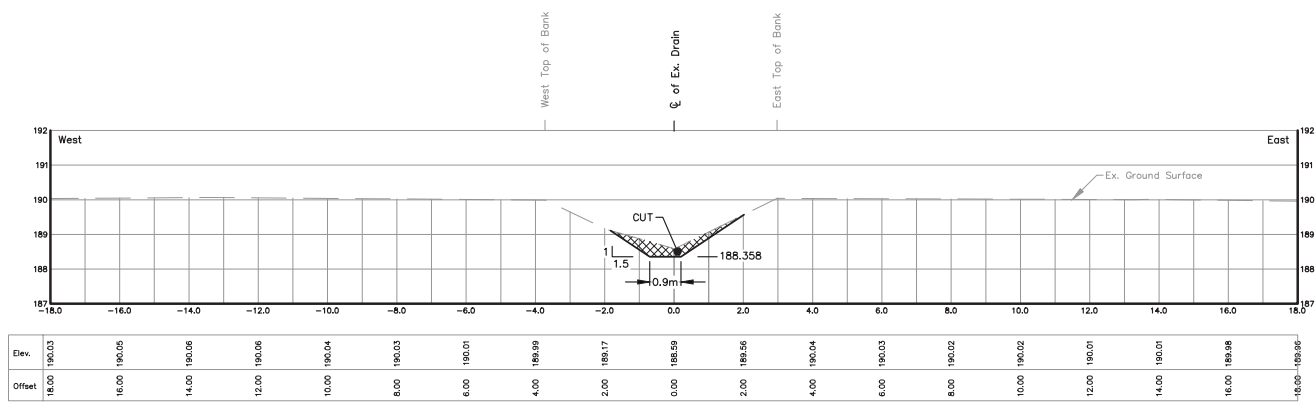

STA. 2+500.6
Scale = 1:100

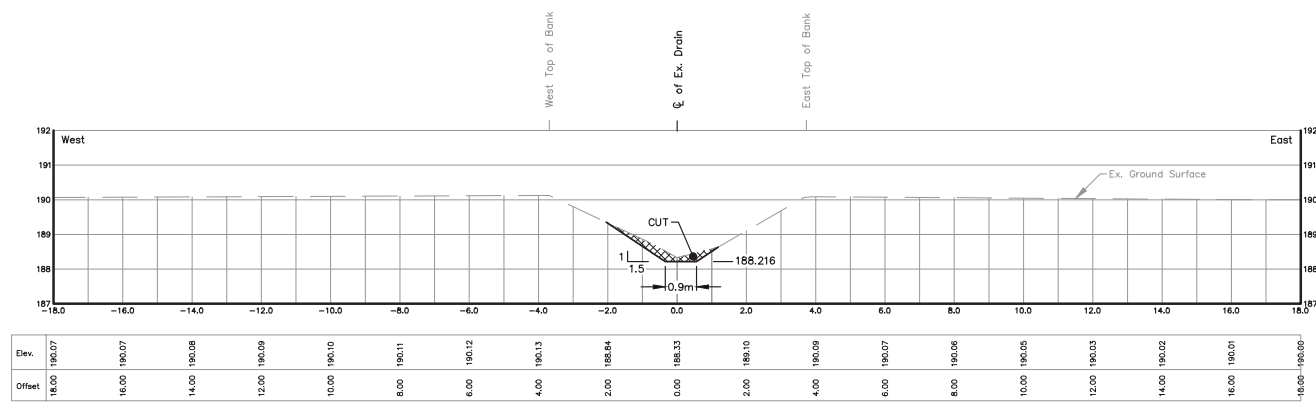

STA. 2+641.5
Scale = 1:100

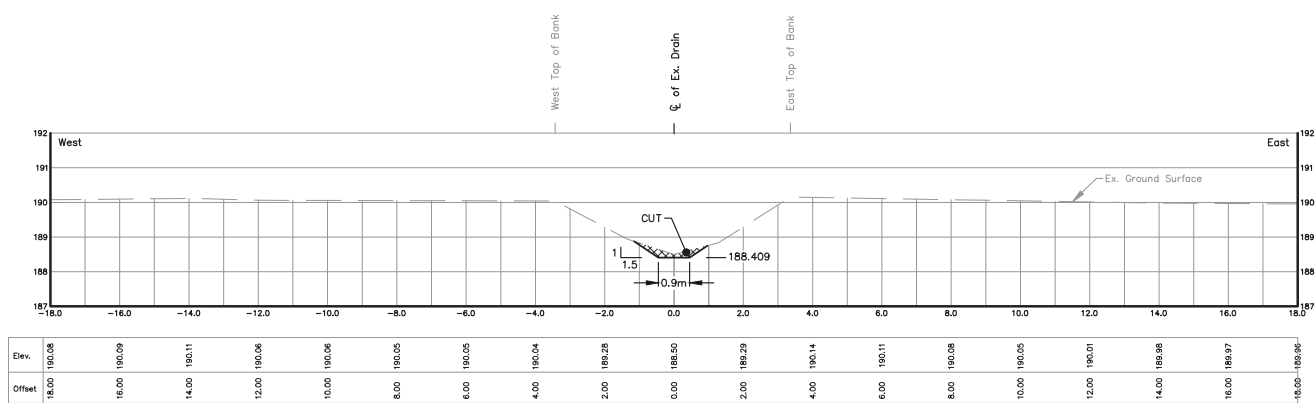

STA. 2+451.1
Scale = 1:100

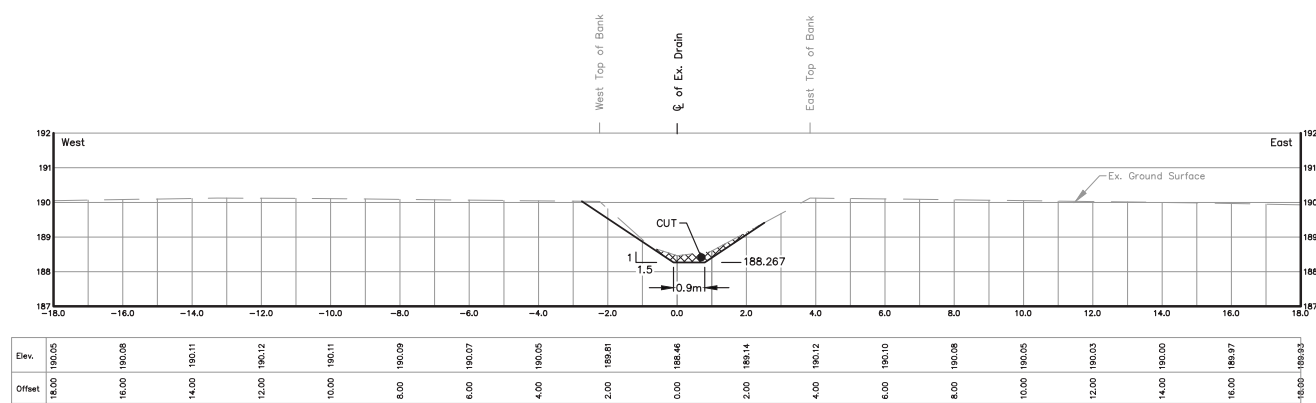

STA. 2+590.6
Scale = 1:100

THESE PLANS HAVE BEEN REDUCED AND THE SCALE THEREFORE VARIES. FULL SCALE PLANS MAY BE VIEWED AT THE MUNICIPAL OFFICE.

DRAWN BY: G.S. & S.H.
PLOT CODE: 1:1
COMPUTER FILE: REI2015D010.DWG
FILE No.: SHEET No.:
2015D010 16 OF 51

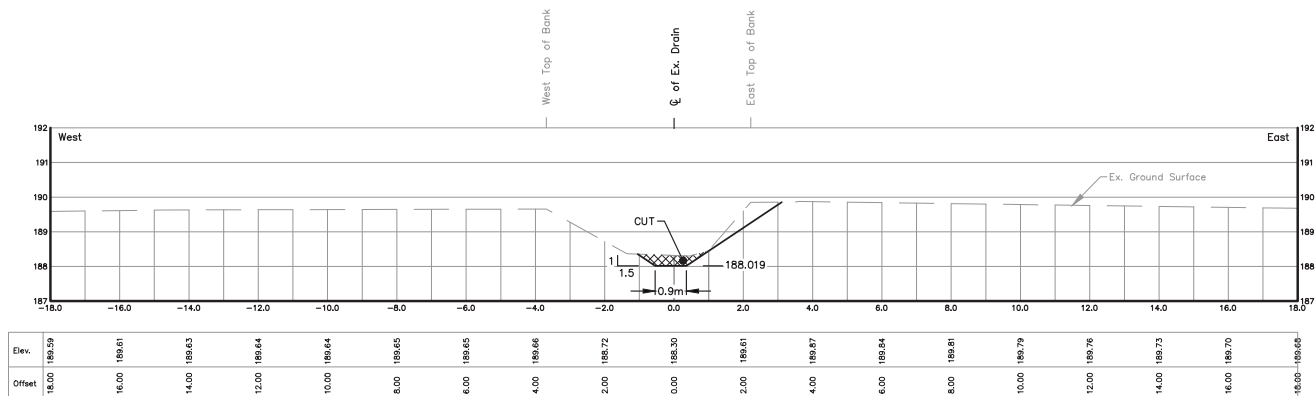

STA. 2+836.1
Scale = 1:100

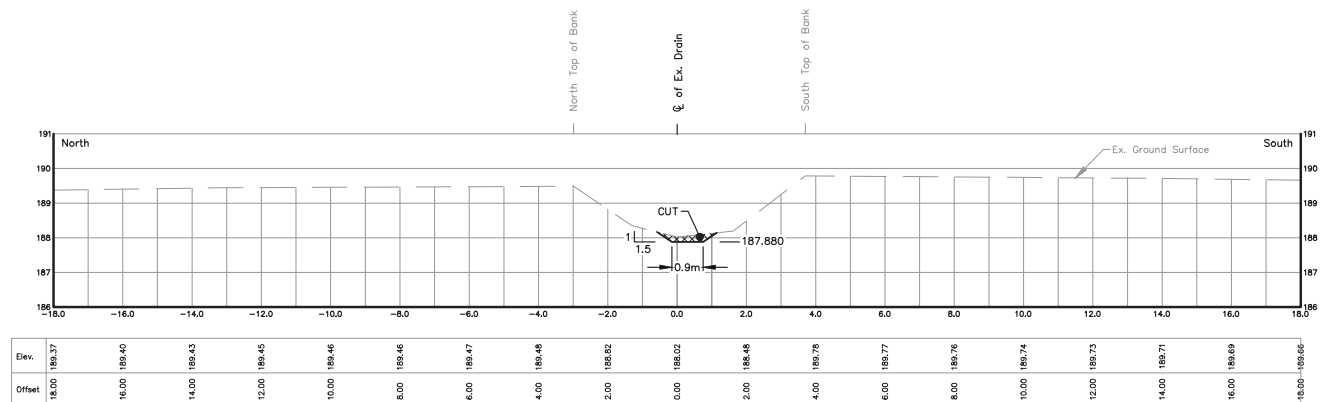

STA. 2+972.9
Scale = 1:100

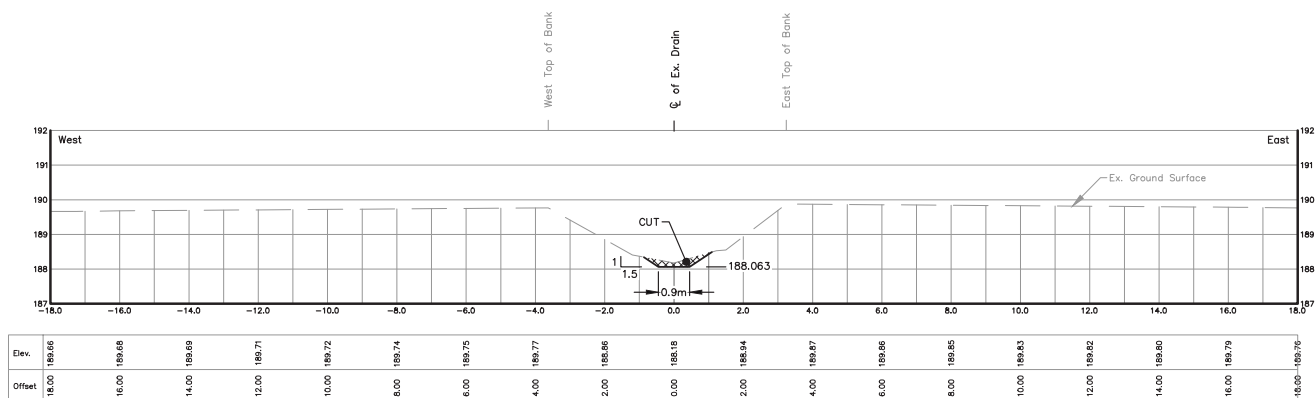

STA. 2+792.8
Scale = 1:100

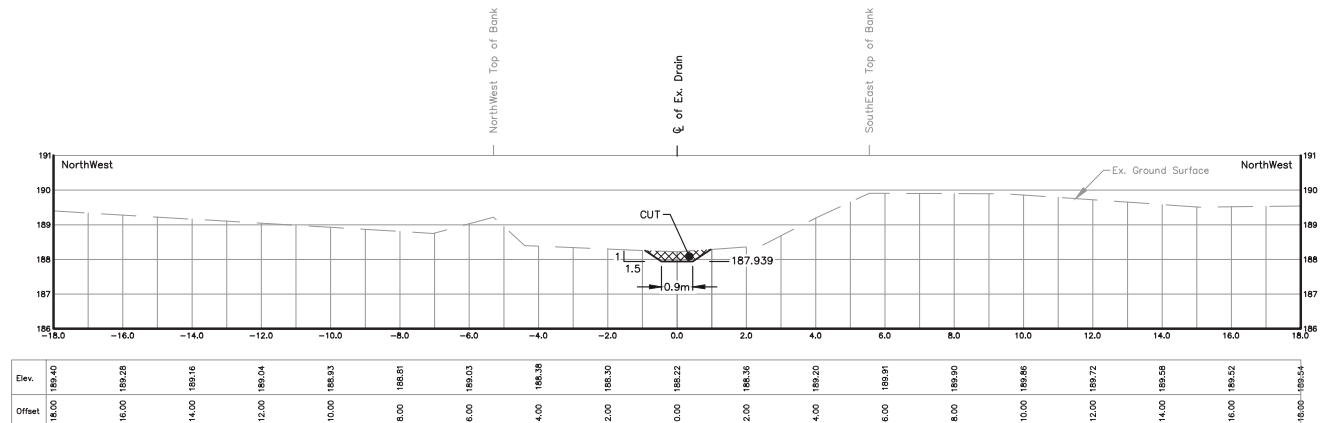

STA. 2+915.2
Scale = 1:100

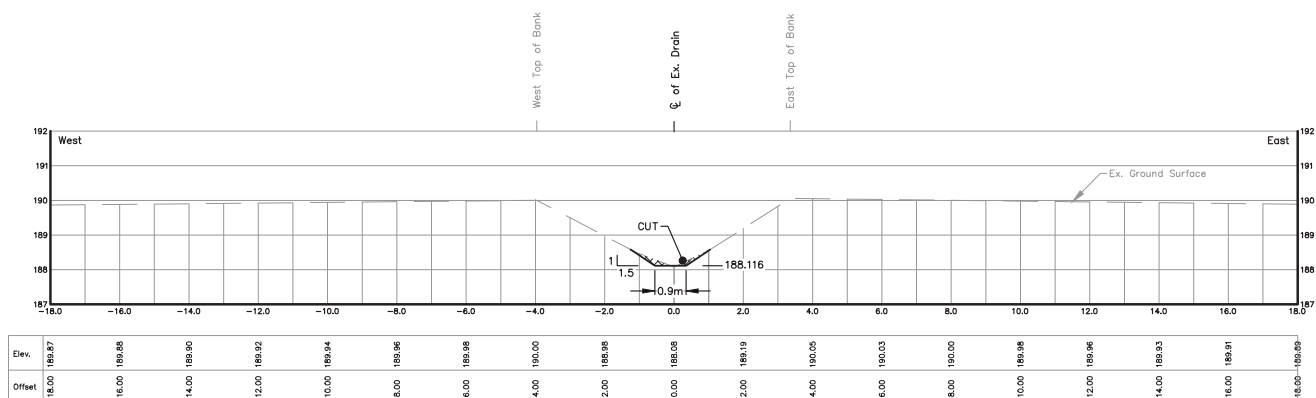

STA. 2+739.9
Scale = 1:100

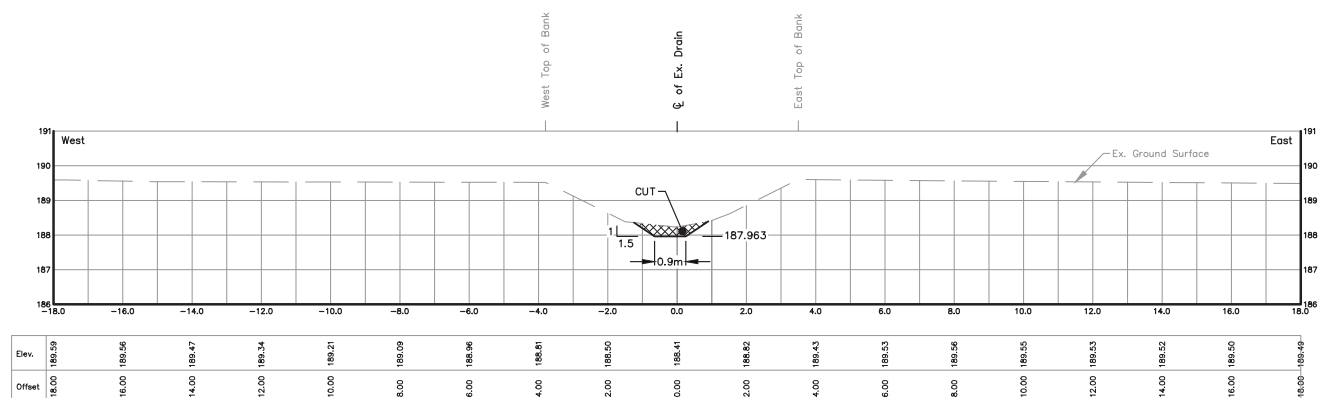

STA. 2+891.3
Scale = 1:100

THESE PLANS HAVE BEEN REDUCED AND THE SCALE THEREFORE VARIES. FULL SCALE PLANS MAY BE VIEWED AT THE MUNICIPAL OFFICE.

DRAWN BY: G.S. & S.H.
PLOT CODE: 1:1
COMPUTER FILE: REI2015D010.DWG
FILE No.: SHEET No.:
2015D010 17 OF 51

9

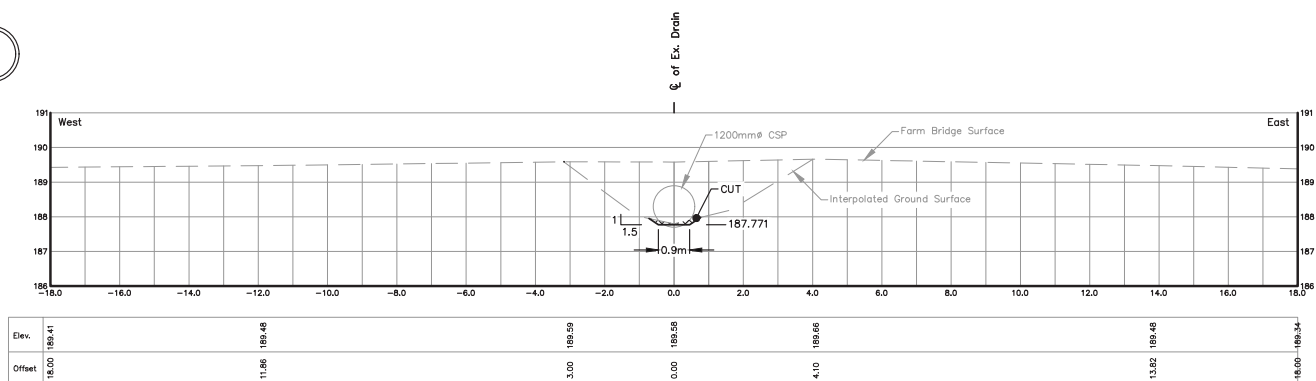

STA. 3+081.2
Scale = 1:100

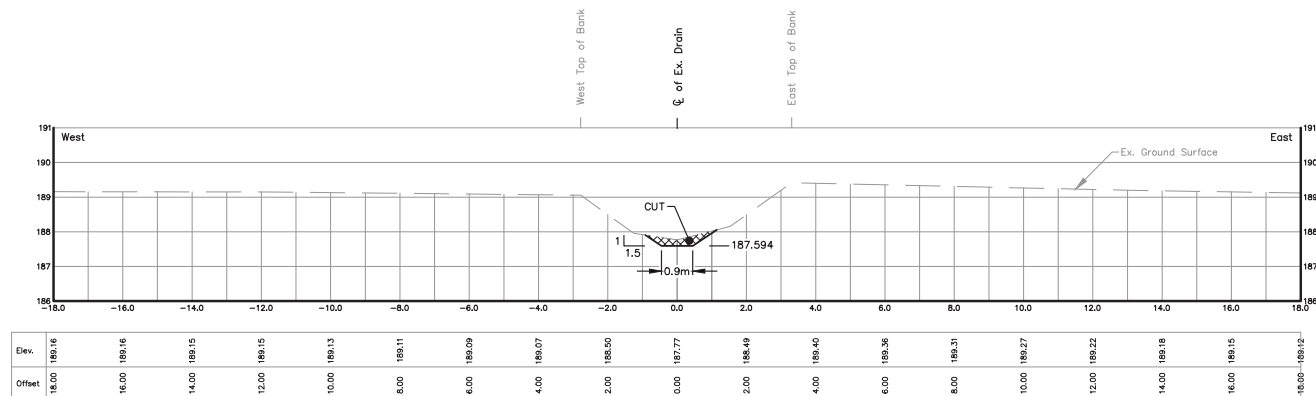

STA. 3+159.6
Scale = 1:100

9

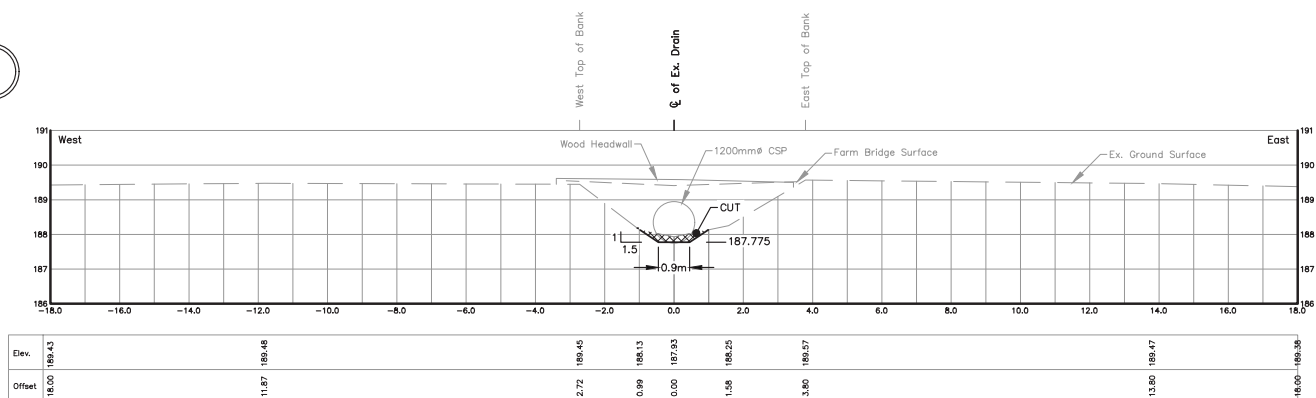

STA. 3+077.4
Scale = 1:100

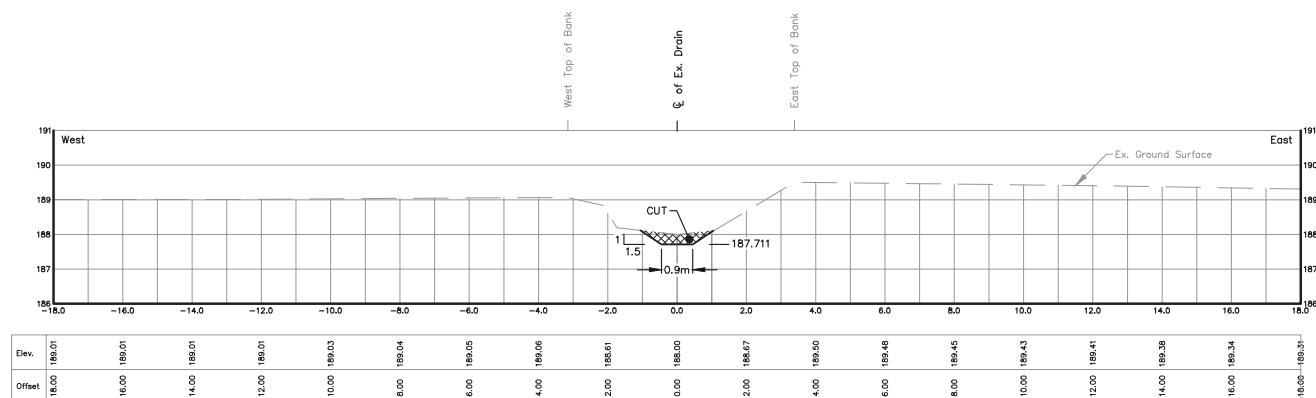

STA. 3+111.0
Scale = 1:100

9

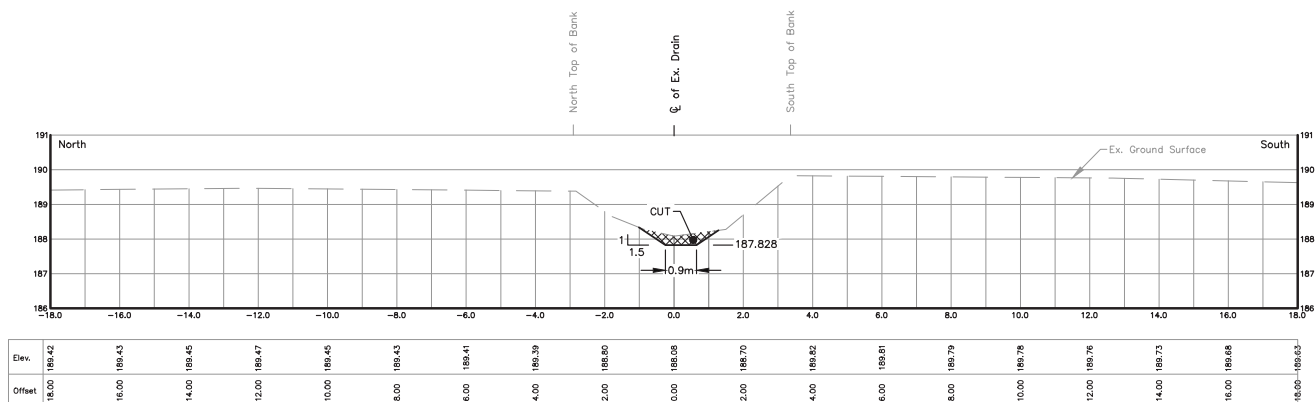

STA. 3+024.4
Scale = 1:100

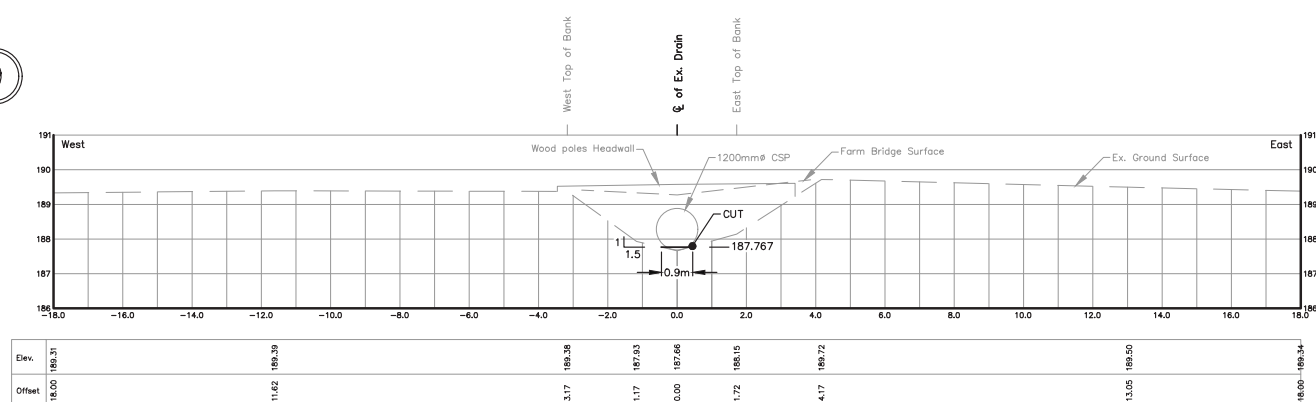

STA. 3+085.0
Scale = 1:100

THESE PLANS HAVE BEEN REDUCED AND THE SCALE THEREFORE VARIES. FULL SCALE PLANS MAY BE VIEWED AT THE MUNICIPAL OFFICE.

11

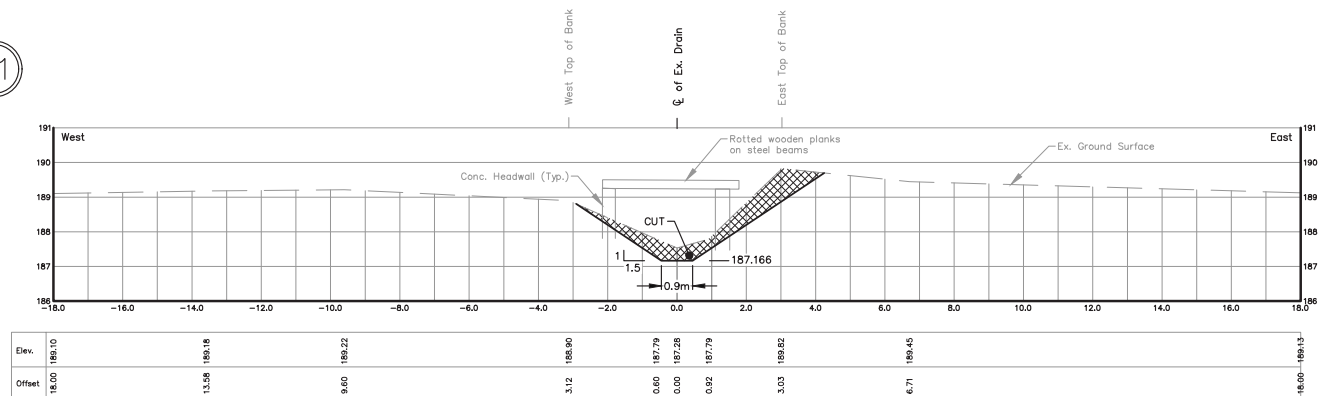

STA. 3+336.0
Scale = 1:100

12

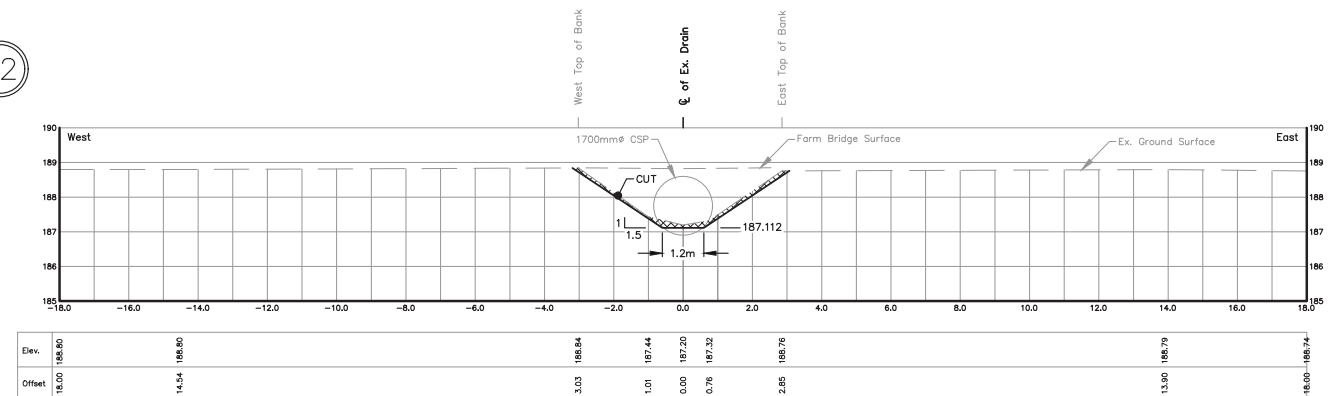

STA. 3+358.4
Scale = 1:100

11

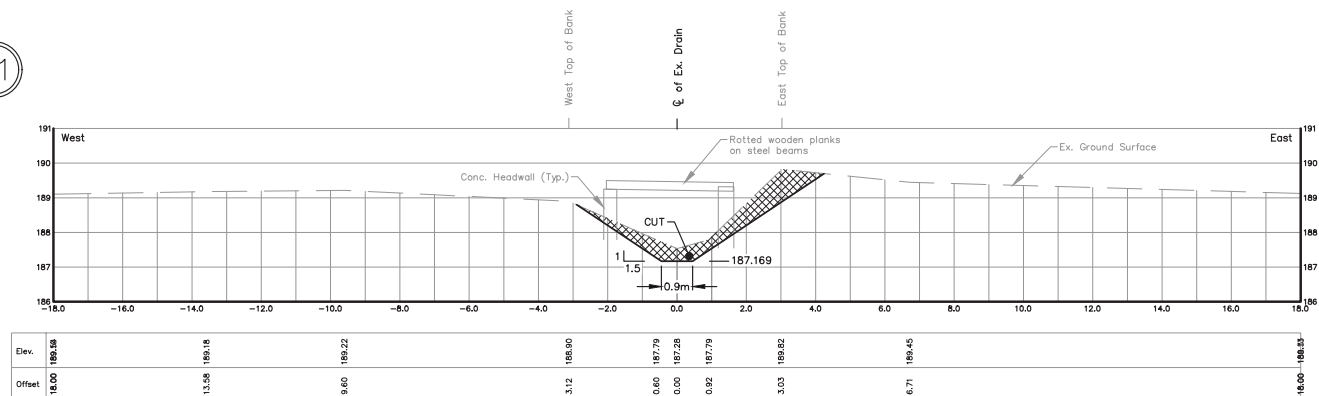

STA. 3+334.9
Scale = 1:100

12

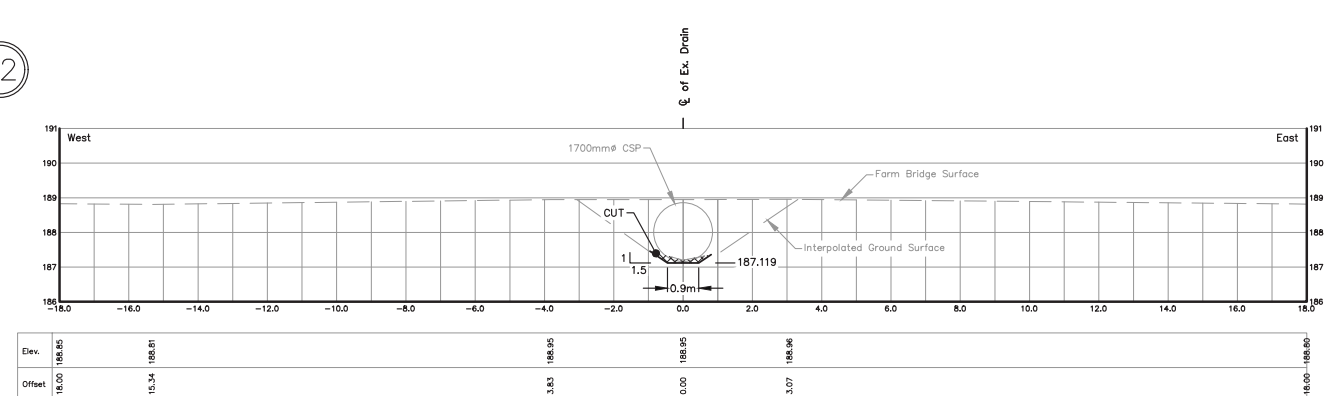

STA. 3+355.5
Scale = 1:100

11

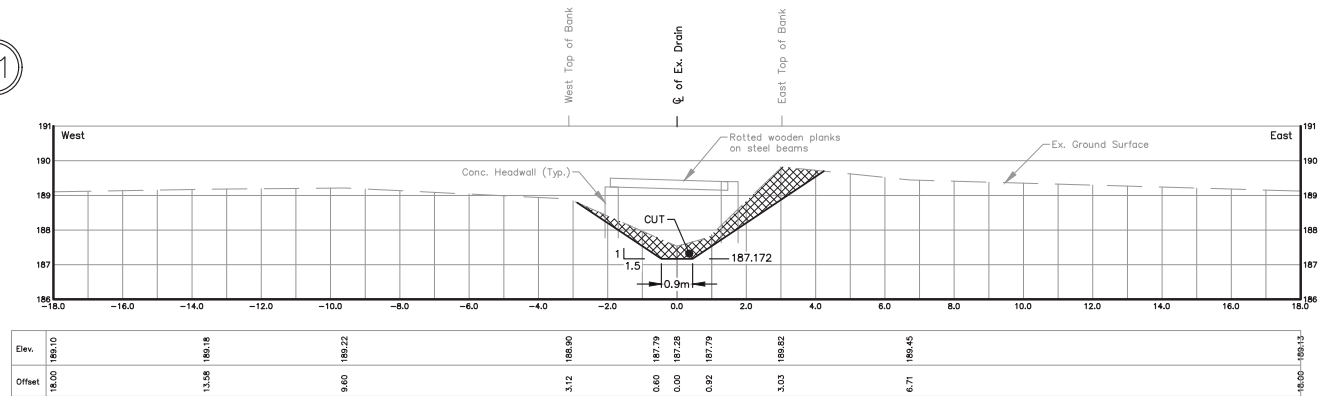

STA. 3+333.7
Scale = 1:100

12

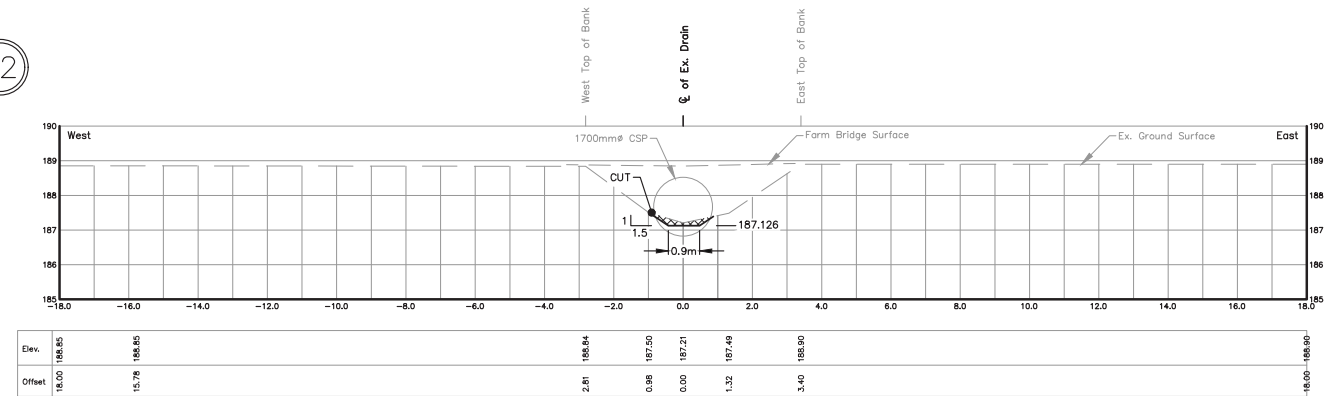

STA. 3+352.5
Scale = 1:100

THESE PLANS HAVE BEEN REDUCED AND THE SCALE THEREFORE VARIES. FULL SCALE PLANS MAY BE VIEWED AT THE MUNICIPAL OFFICE.

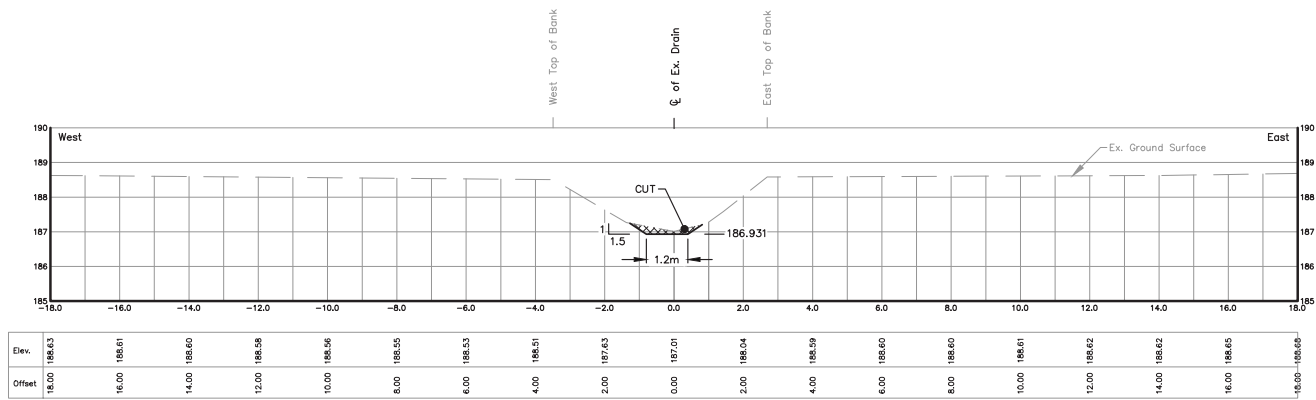

STA. 3+492.6
Scale = 1:100

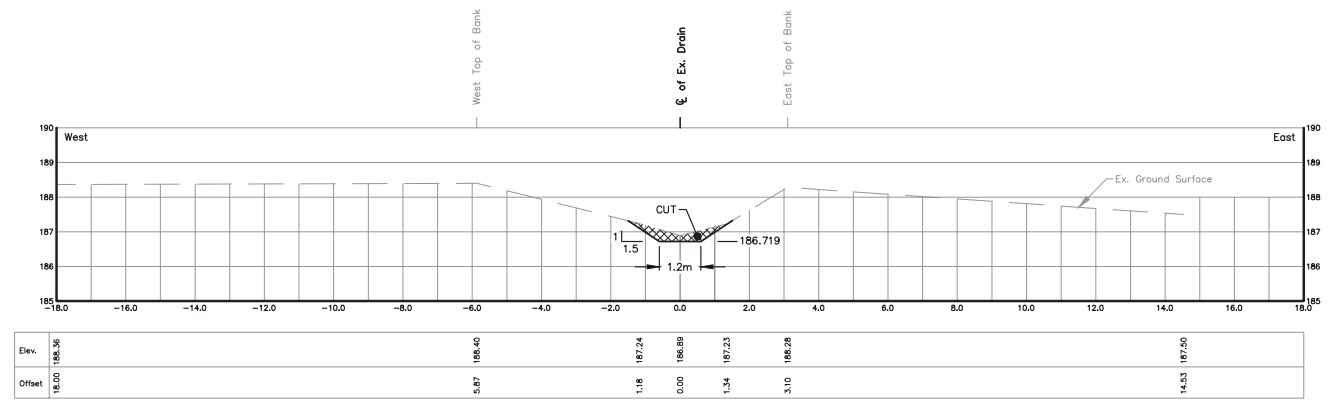

STA. 3+655.6
Scale = 1:100

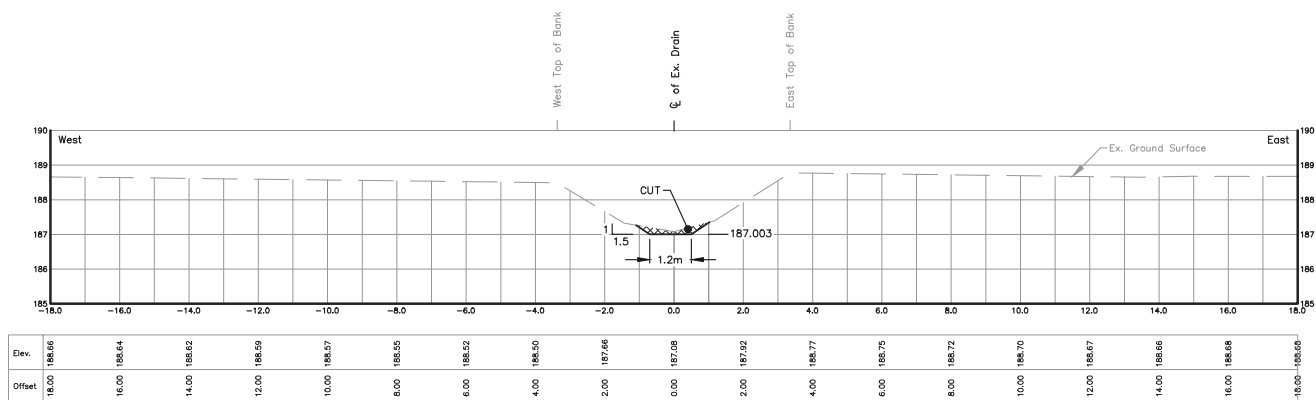

STA. 3+436.9
Scale = 1:100

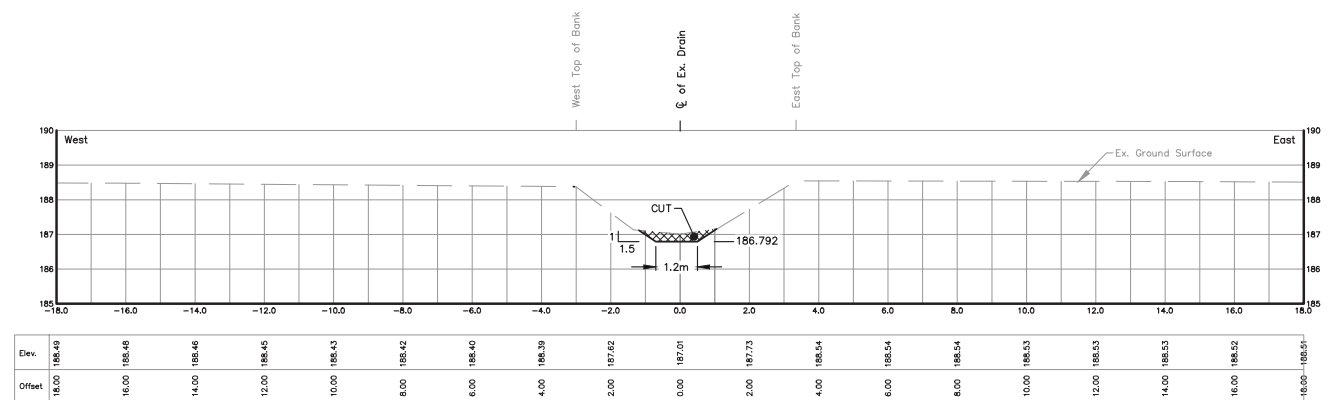

STA. 3+599.6
Scale = 1:100

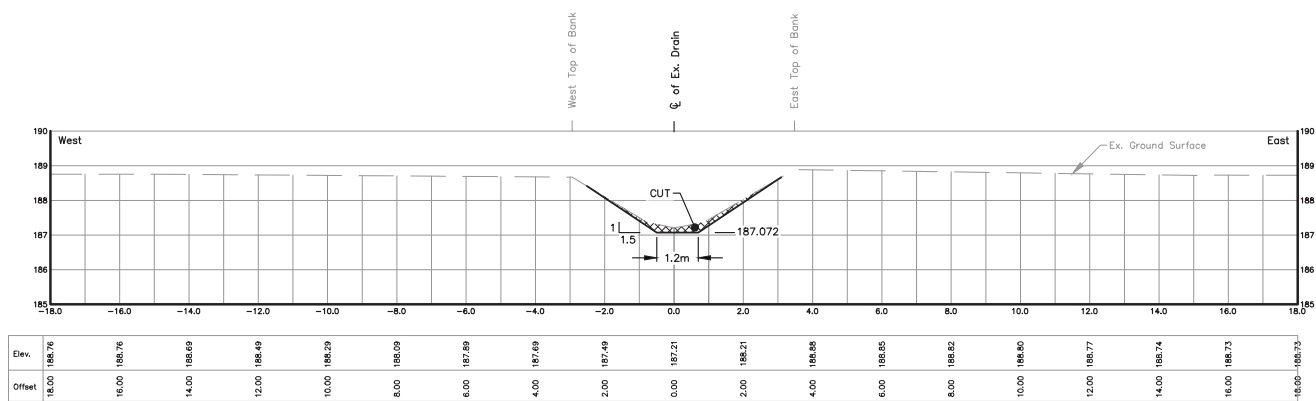

STA. 3+384.2
Scale = 1:100

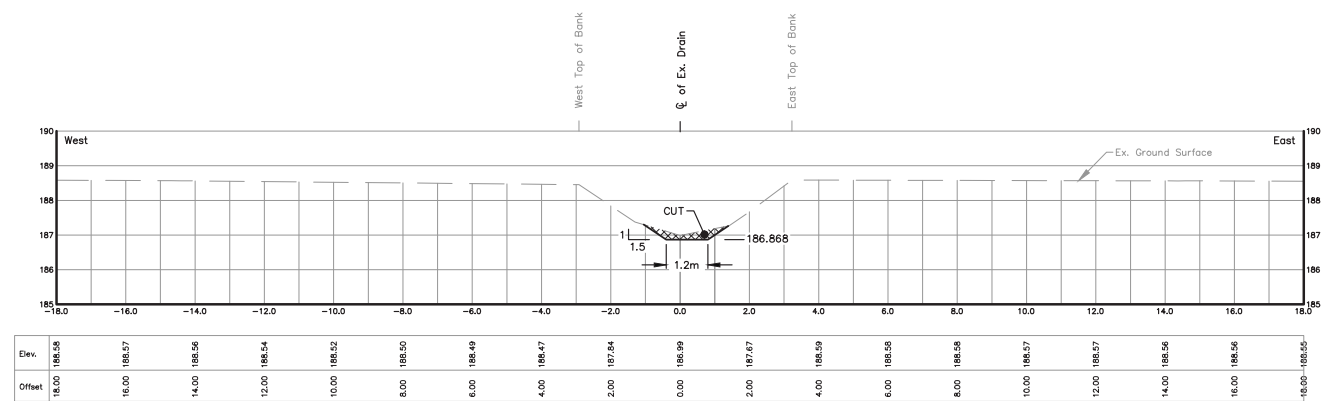

STA. 3+541.3
Scale = 1:100

THESE PLANS HAVE BEEN REDUCED
AND THE SCALE THEREFORE VARIES.
FULL SCALE PLANS MAY BE VIEWED
AT THE MUNICIPAL OFFICE.

DRAWN BY: G.S. & S.H.
PLOT CODE: 1:1
COMPUTER FILE: REI2015D010.DWG
FILE No.: SHEET No.:
2015D010 21 OF 51

13

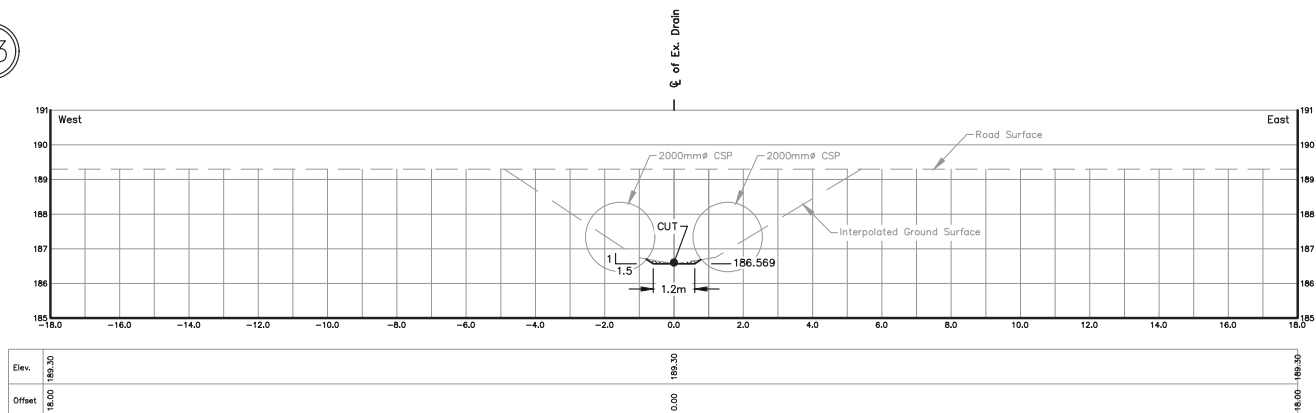

STA. 3+771.1
Scale = 1:100

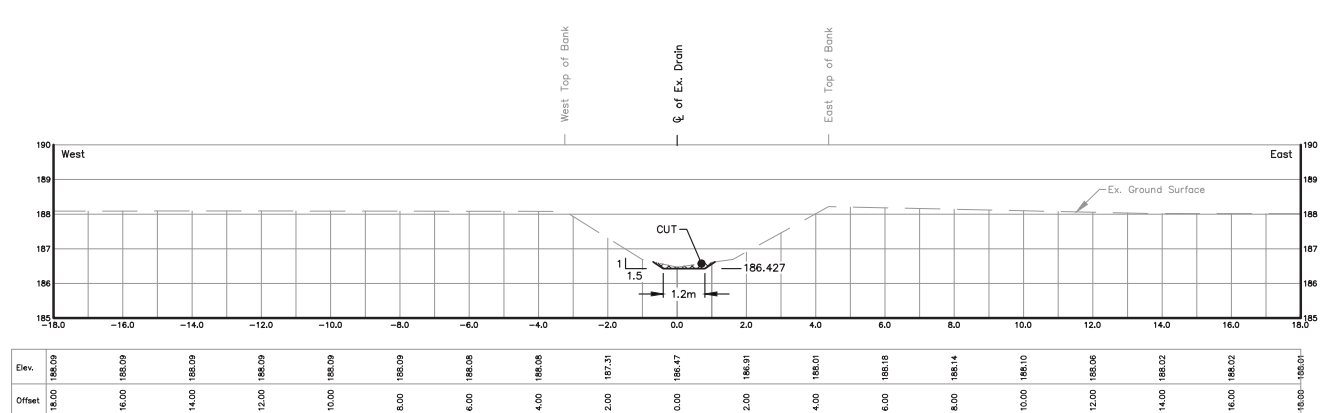

STA. 3+879.9
Scale = 1:100

13

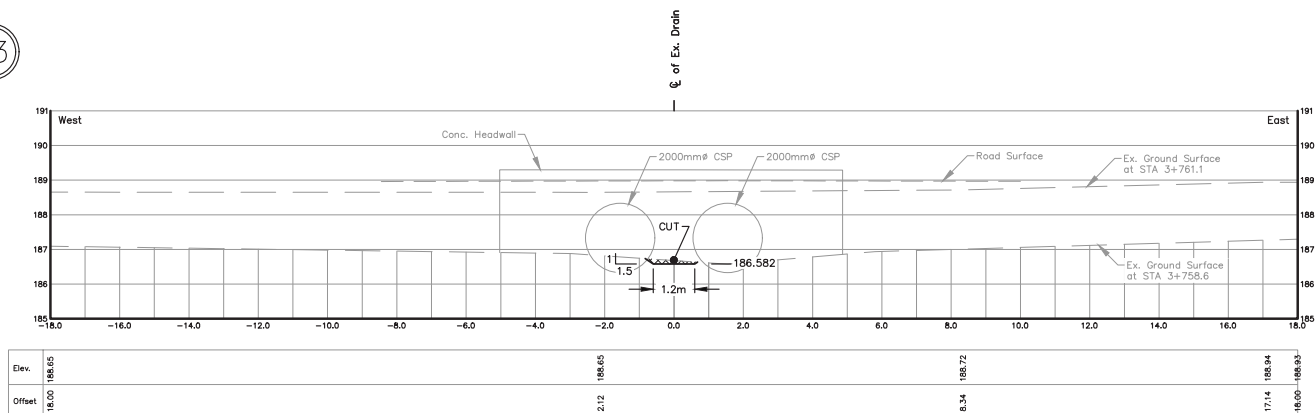

STA. 3+761.1
Scale = 1:100

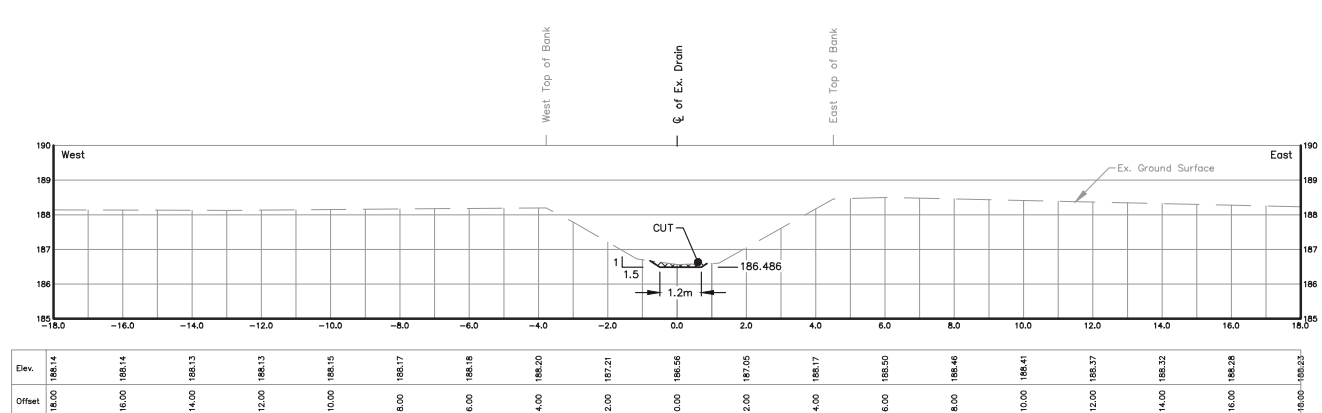

STA. 3+835.2
Scale = 1:100

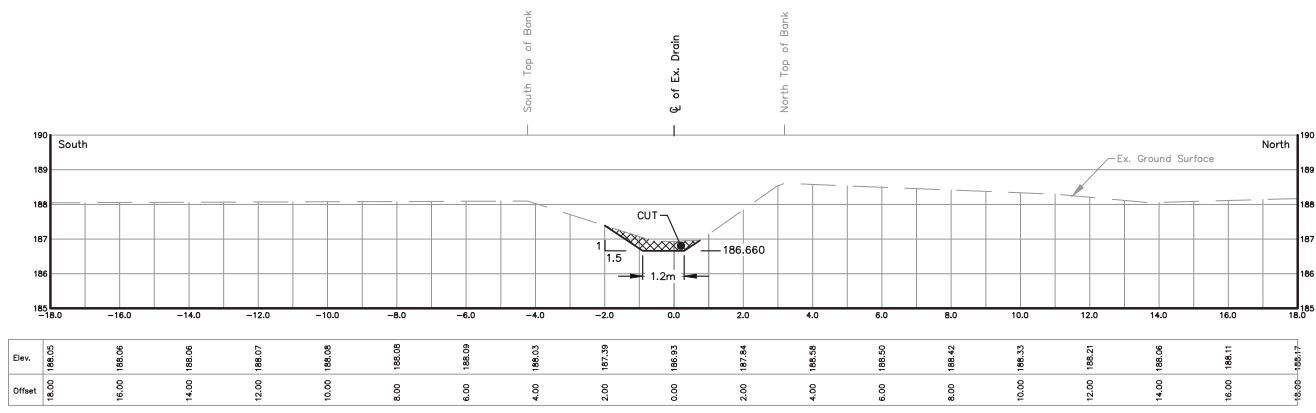

STA. 3+700.8
Scale = 1:100

13

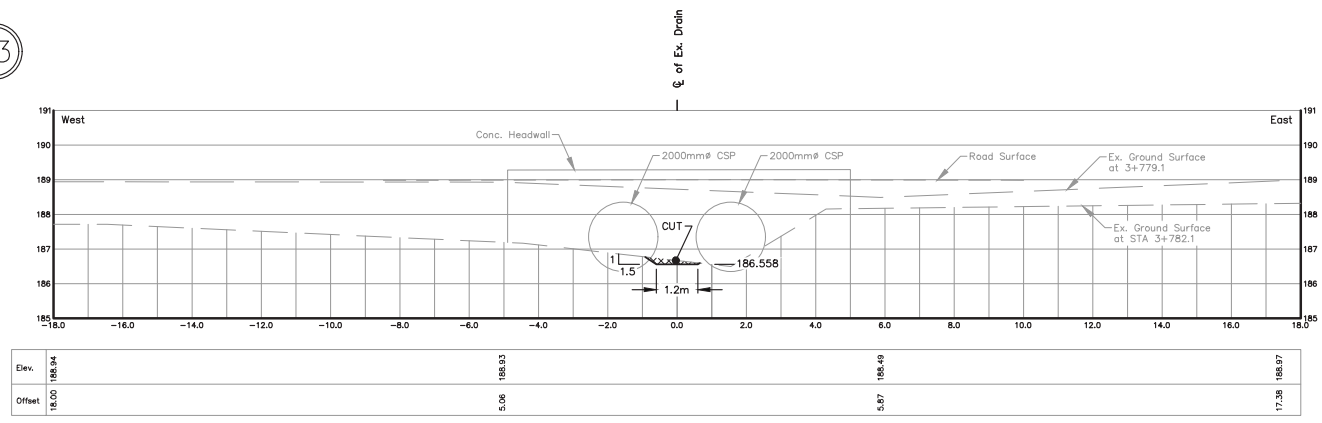

STA. 3+779.1
Scale = 1:100

THESE PLANS HAVE BEEN REDUCED AND THE SCALE THEREFORE VARIES. FULL SCALE PLANS MAY BE VIEWED AT THE MUNICIPAL OFFICE.

DRAWN BY: G.S. & S.H.
PLOT CODE: 1:1
COMPUTER FILE: REI2015D010.DWG
FILE No.: SHEET No.:
2015D010 22 OF 51

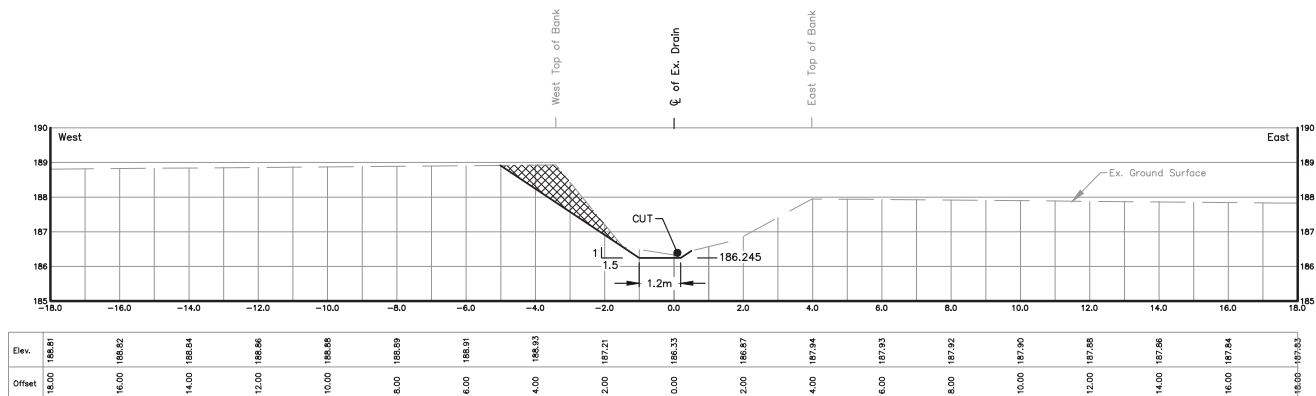

STA. 4+020.2
Scale = 1:100

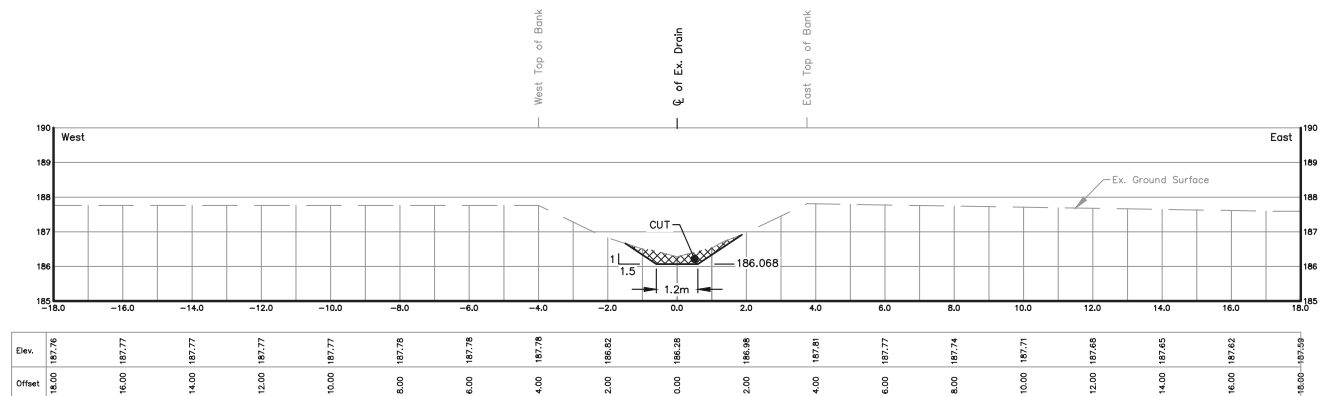

STA. 4+156.3
Scale = 1:100

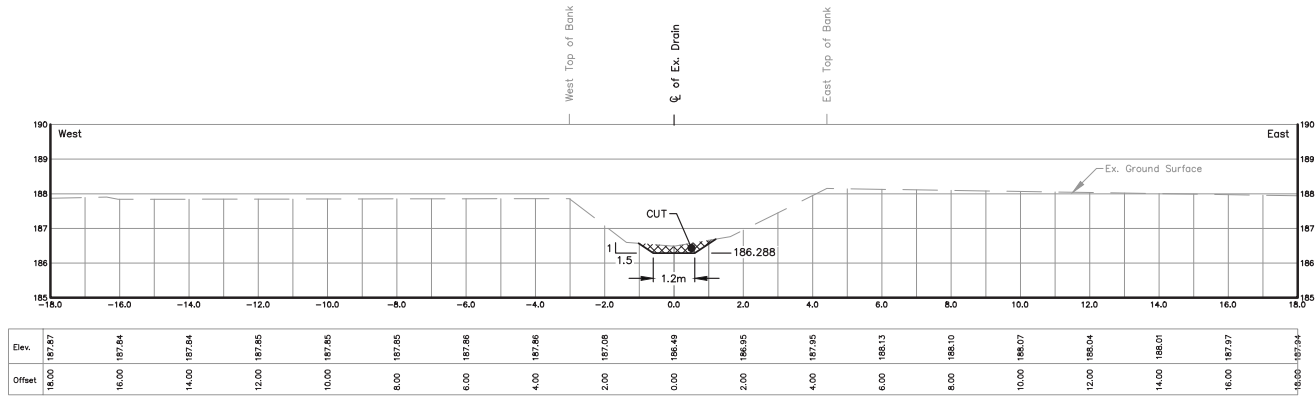

STA. 3+987.4
Scale = 1:100

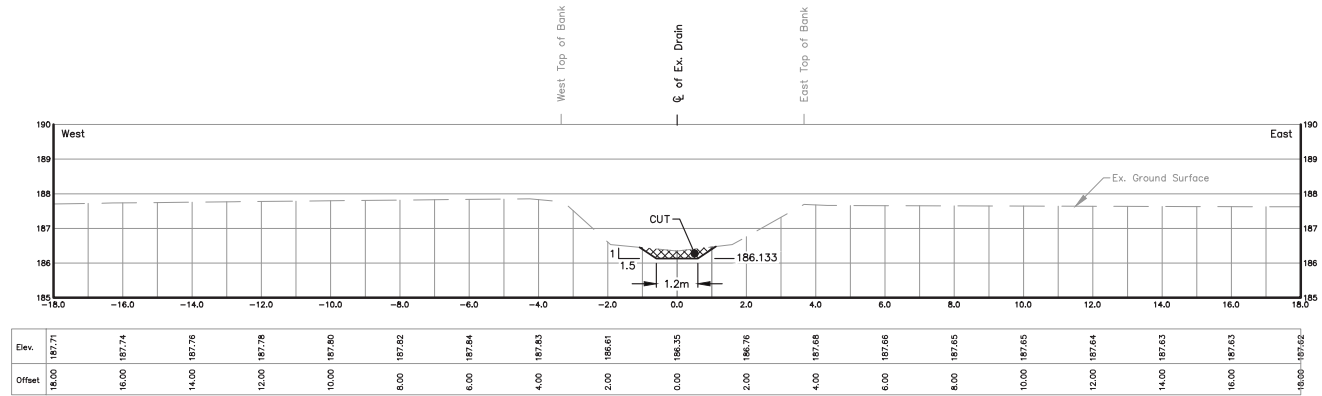

STA. 4+106.0
Scale = 1:100

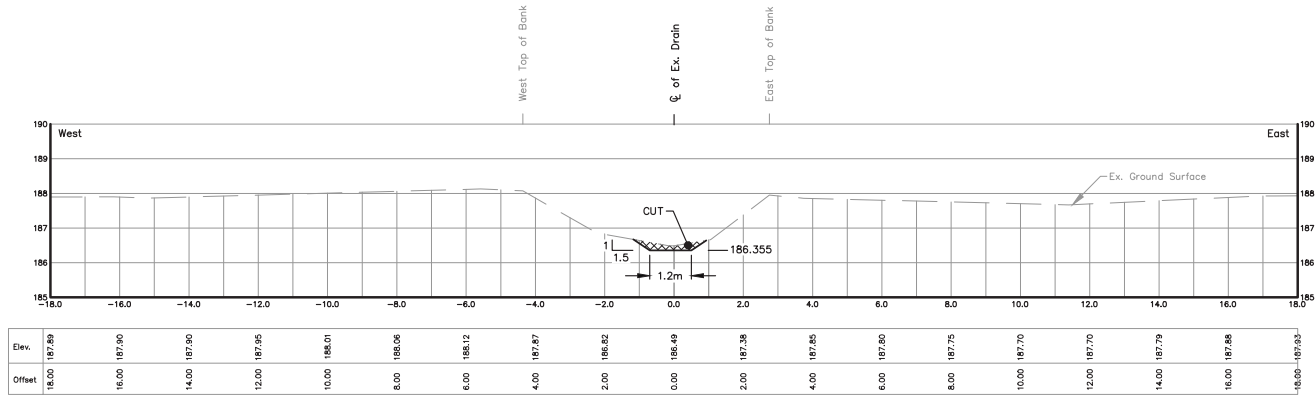

STA. 3+935.9
Scale = 1:100

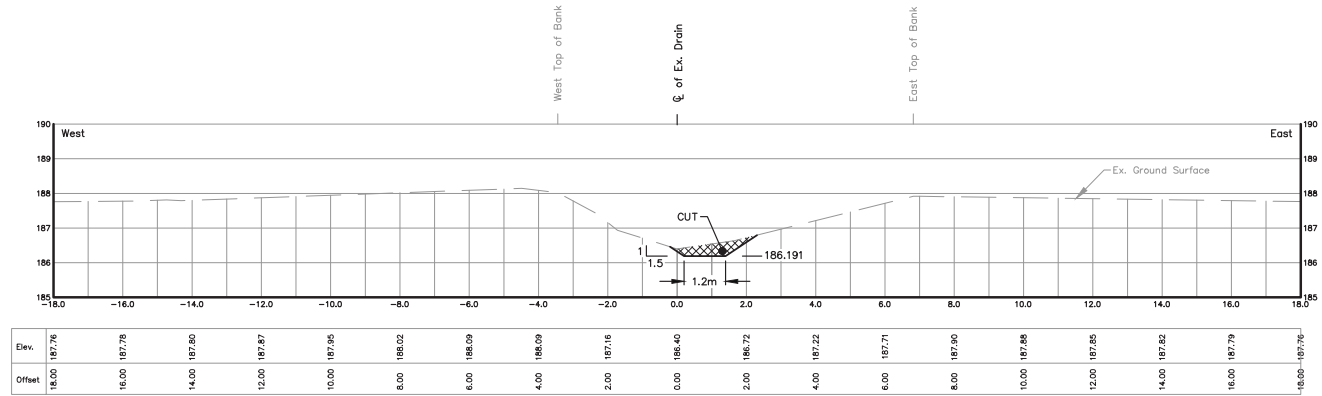

STA. 4+061.5
Scale = 1:100

THESE PLANS HAVE BEEN REDUCED AND THE SCALE THEREFORE VARIES. FULL SCALE PLANS MAY BE VIEWED AT THE MUNICIPAL OFFICE.

DRAWN BY: G.S. & S.H.
PLOT CODE: 1:1
COMPUTER FILE: REI2015D010.DWG
FILE No.: SHEET No.:
2015D010 23 OF 51

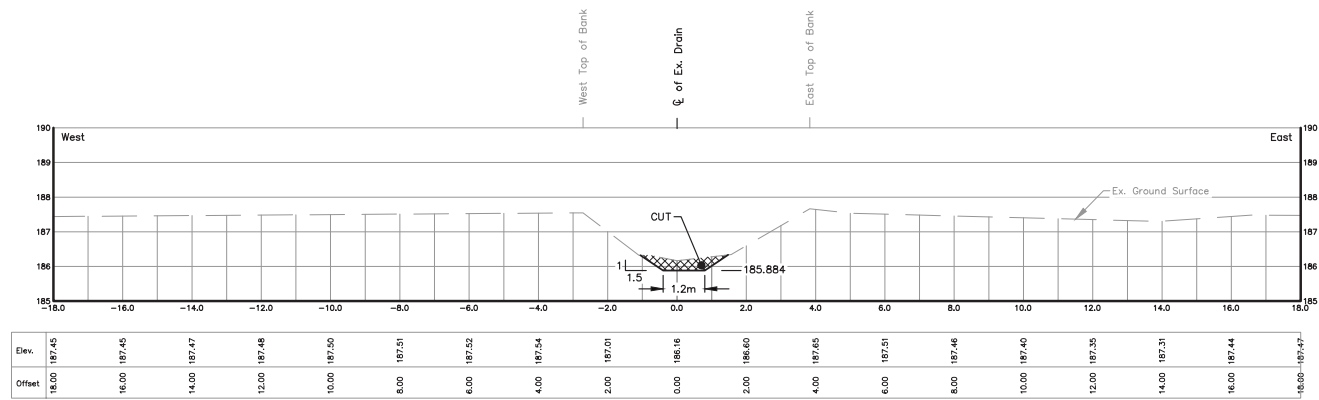

STA. 4+297.4
Scale = 1:100

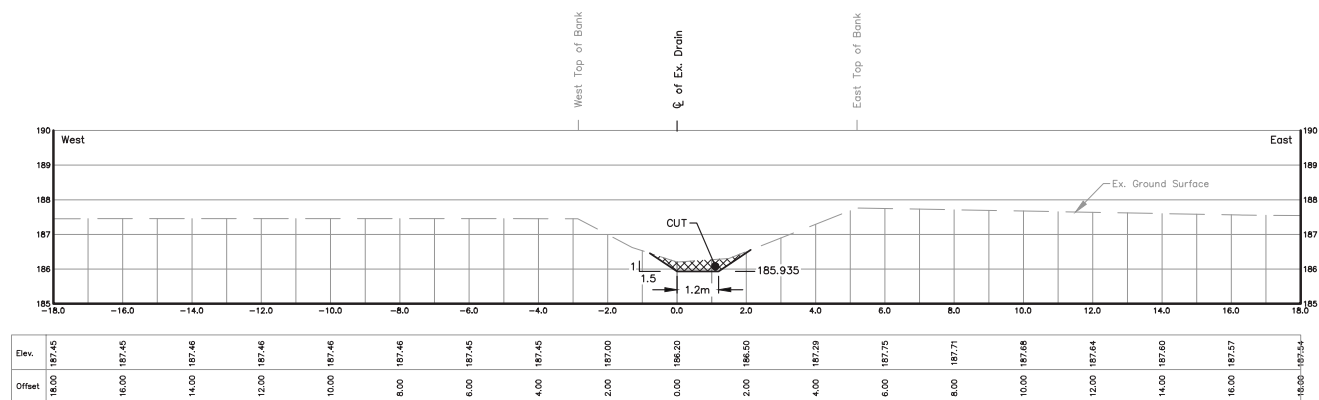

STA. 4+258.3
Scale = 1:100

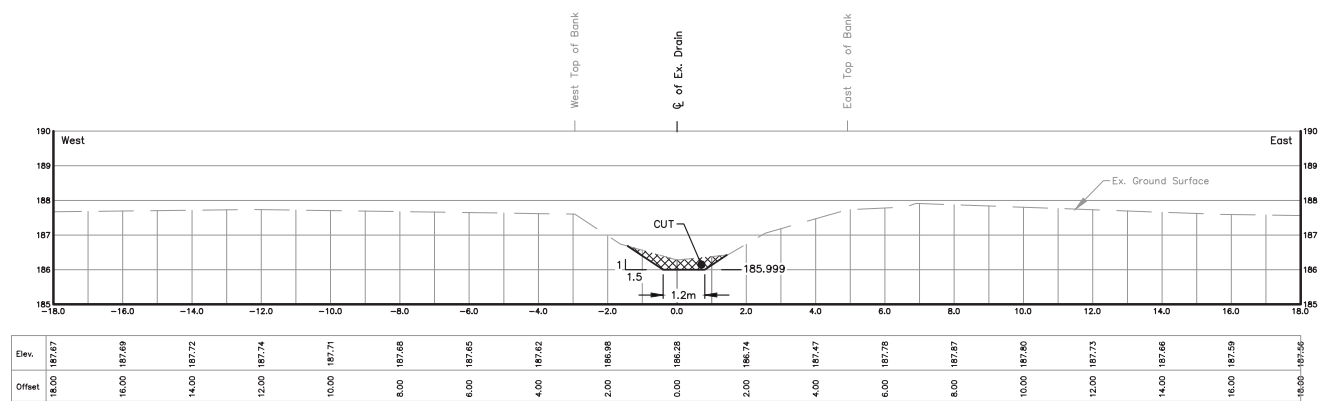

STA. 4+209.2
Scale = 1:100

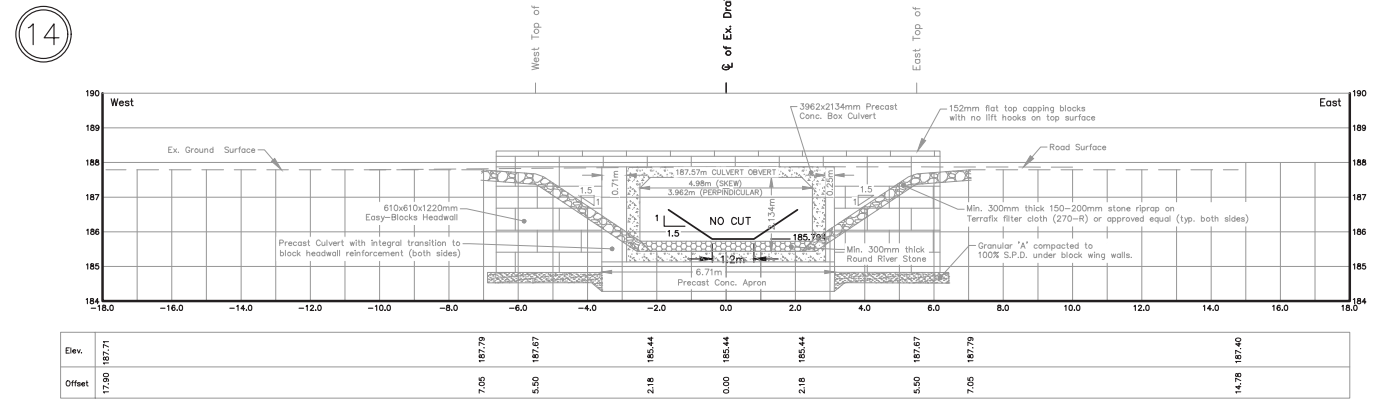

STA. 4+365.8
Scale = 1:100

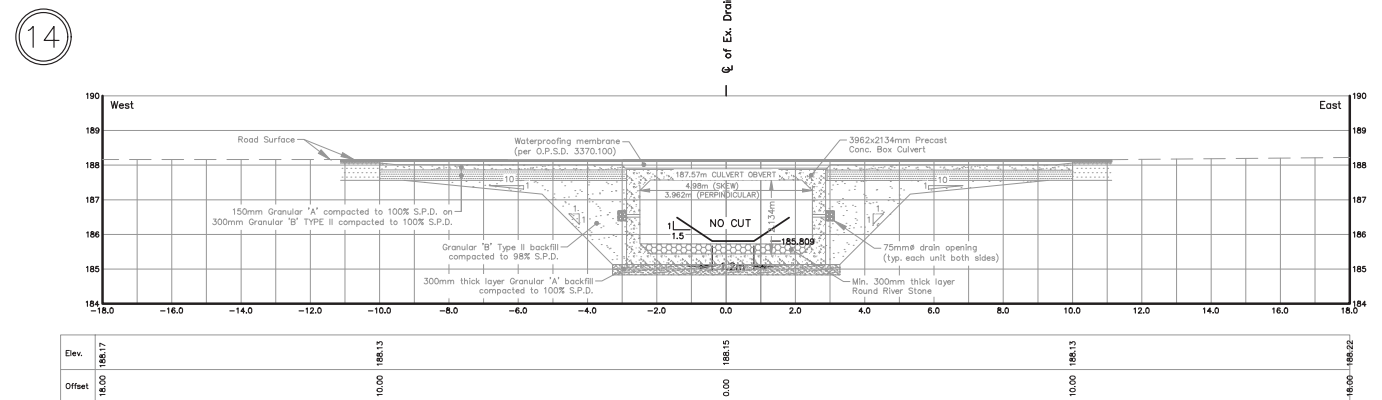

STA. 4+355.1
Scale = 1:100

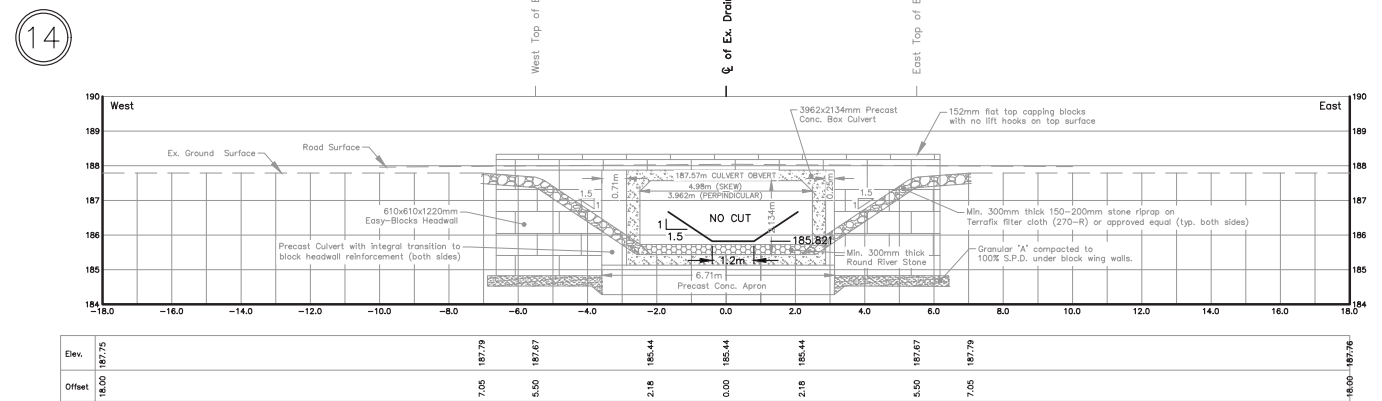

STA. 4+344.3
Scale = 1:100

THESE PLANS HAVE BEEN REDUCED
AND THE SCALE THEREFORE VARIES.
FULL SCALE PLANS MAY BE VIEWED
AT THE MUNICIPAL OFFICE.

DRAWN BY: G.S. & S.H.
PLOT CODE: 1:1
COMPUTER FILE: REI2015D010.DWG
FILE No.: SHEET No.:
2015D010 24 OF 51

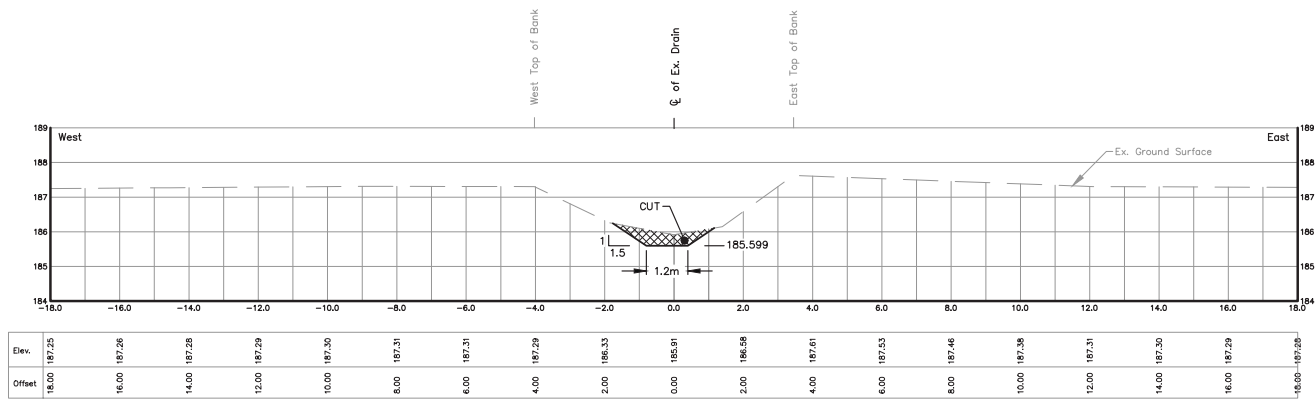

STA. 4+517.0
Scale = 1:100

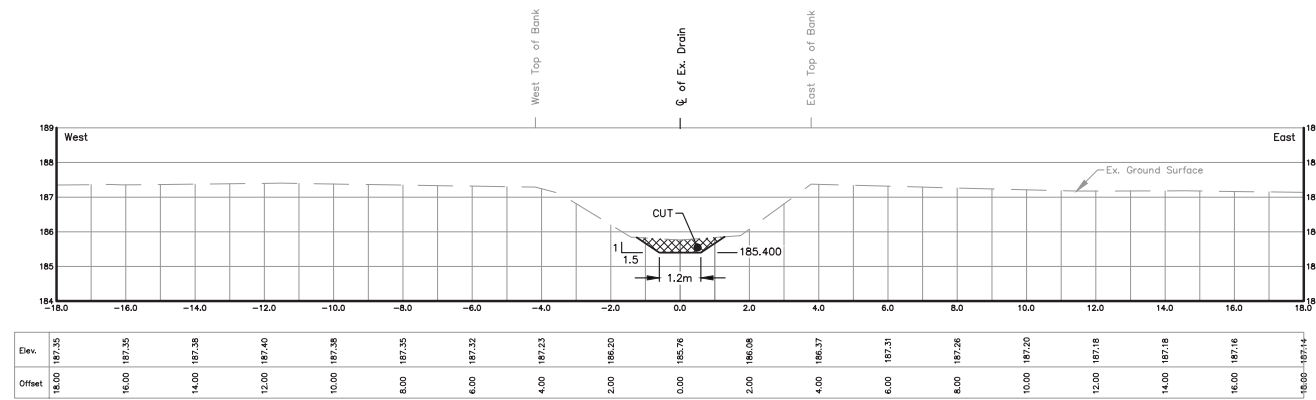

STA. 4+669.7
Scale = 1:100

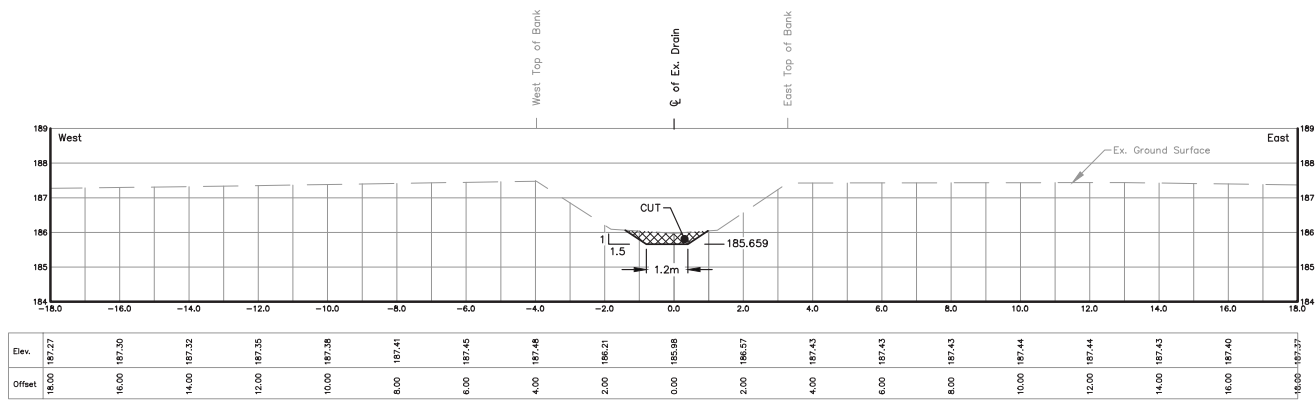

STA. 4+470.8
Scale = 1:100

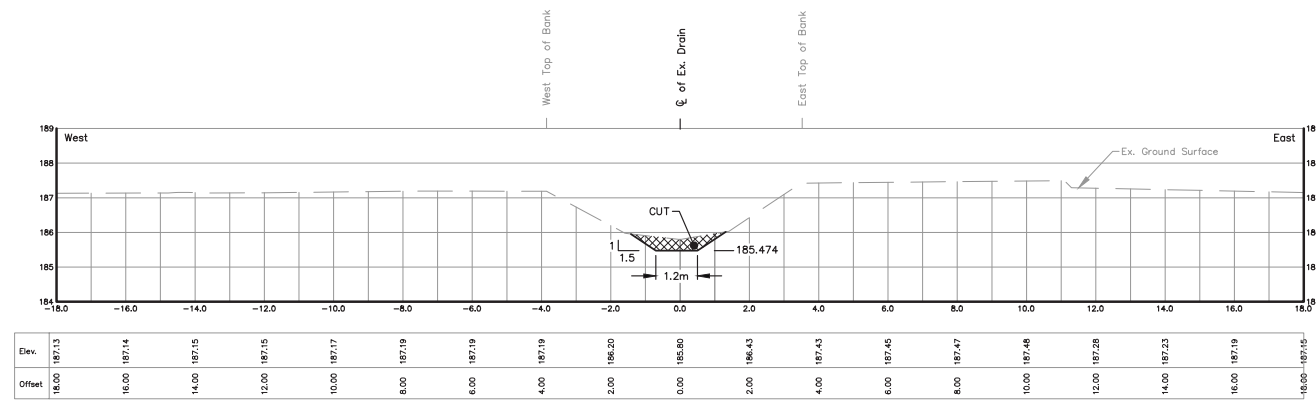

STA. 4+612.7
Scale = 1:100

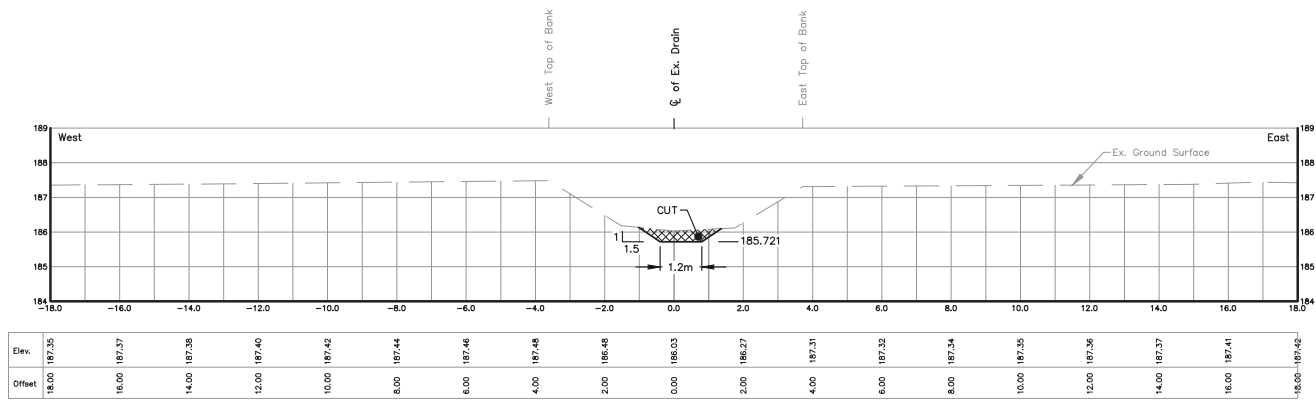

STA. 4+423.0
Scale = 1:100

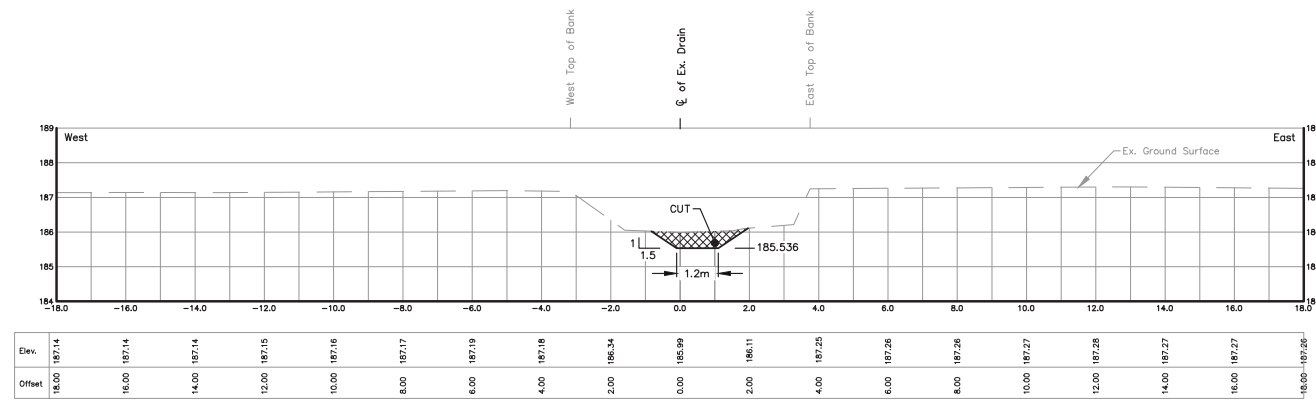

STA. 4+565.3
Scale = 1:100

THESE PLANS HAVE BEEN REDUCED AND THE SCALE THEREFORE VARIES. FULL SCALE PLANS MAY BE VIEWED AT THE MUNICIPAL OFFICE.

DRAWN BY: G.S. & S.H.
PLOT CODE: 1:1
COMPUTER FILE: REI2015D010.DWG
FILE No.: SHEET No.:
2015D010 25 OF 51

15

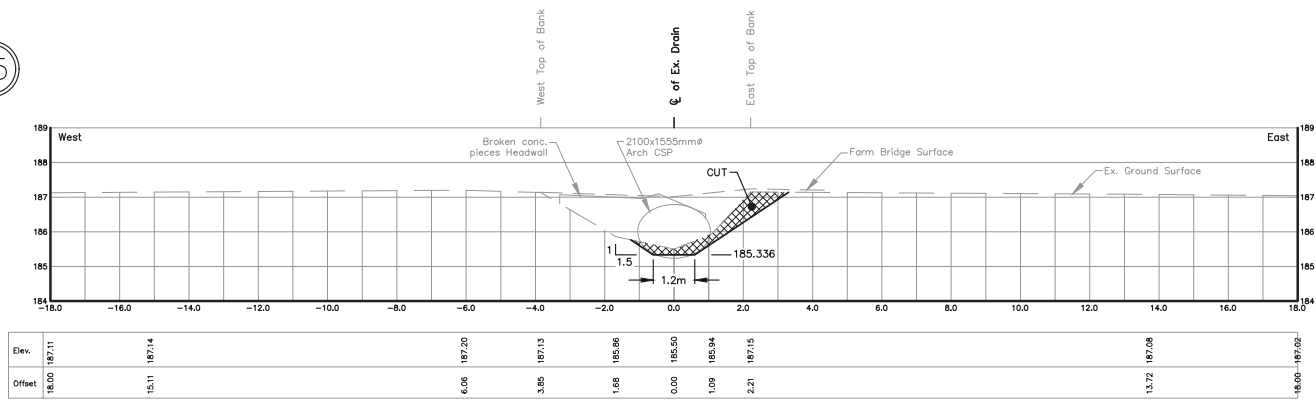

STA. 4+718.9
Scale = 1:100

15

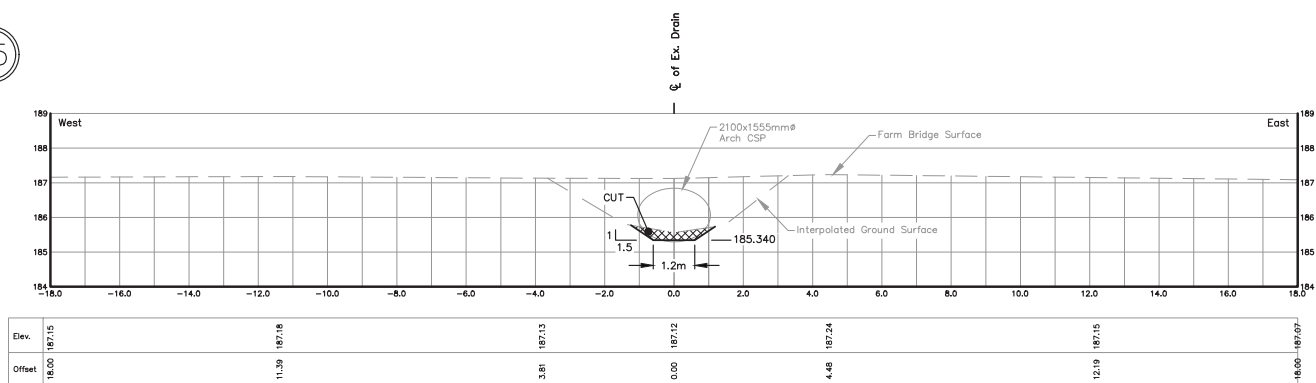

STA. 4+715.9
Scale = 1:100

15

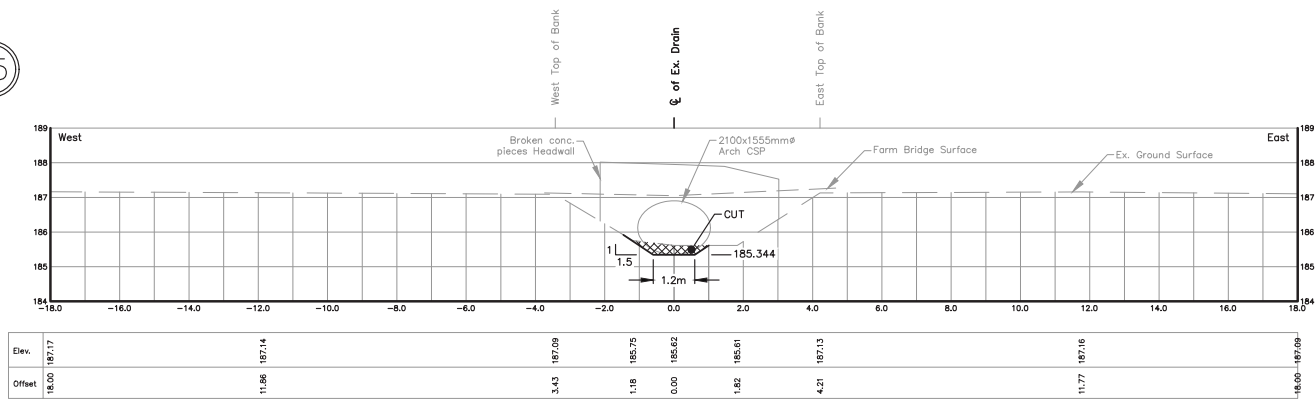

STA. 4+712.9
Scale = 1:100

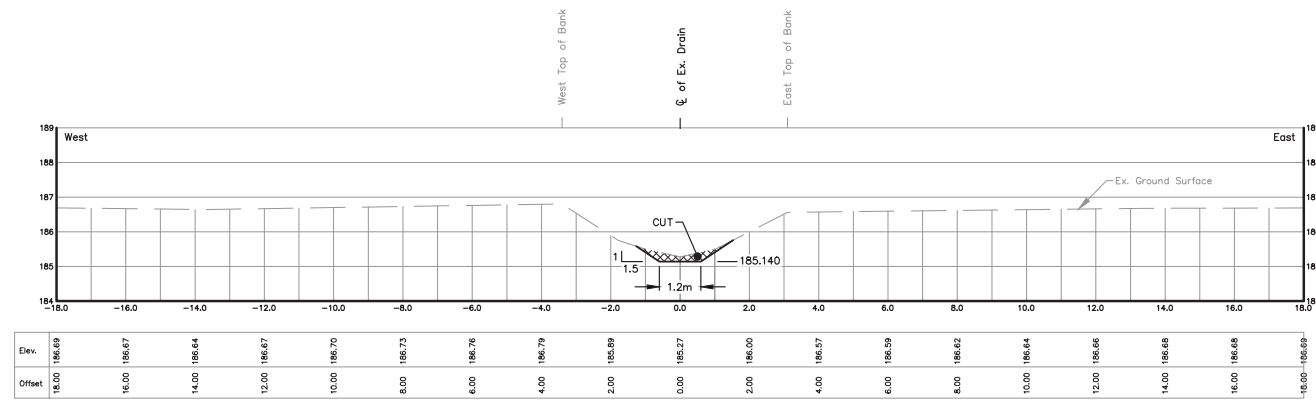

STA. 4+869.6
Scale = 1:100

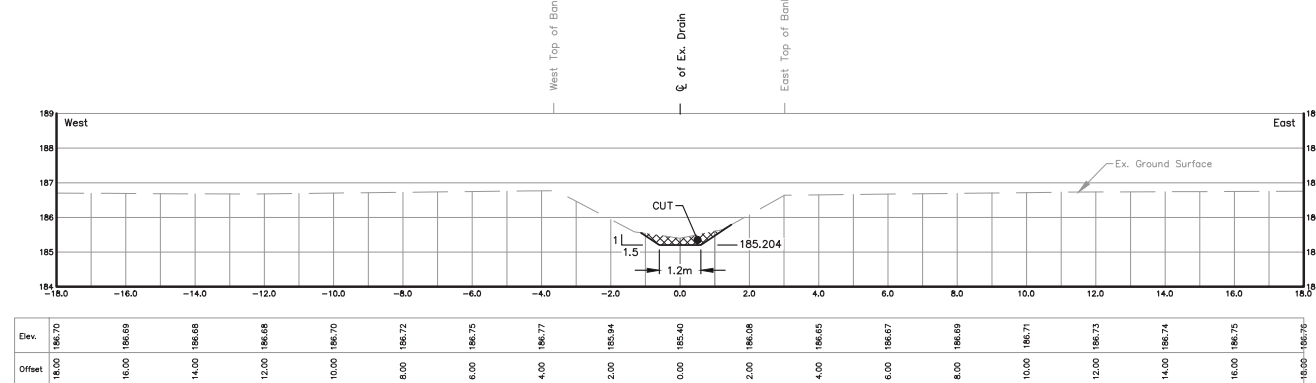

STA. 4+820.3
Scale = 1:100

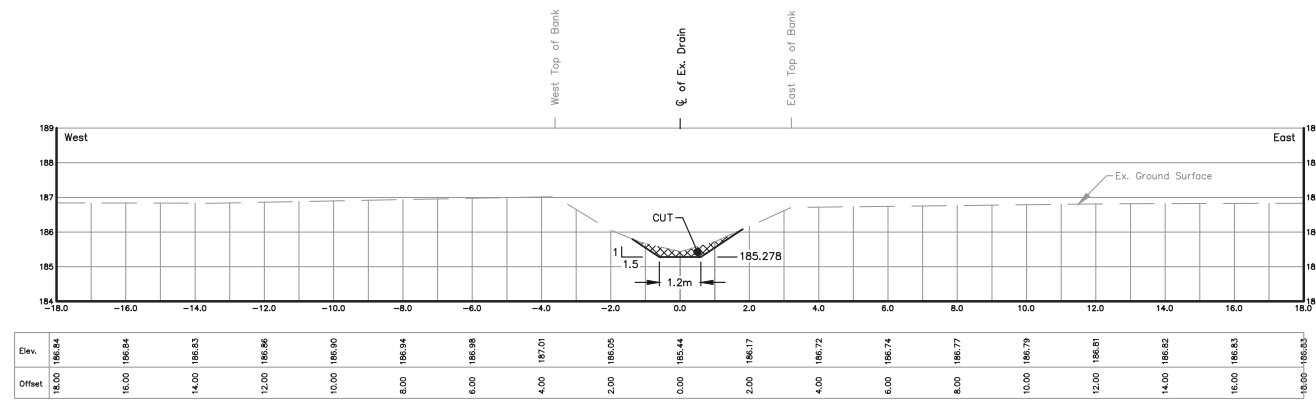

STA. 4+763.8
Scale = 1:100

THESE PLANS HAVE BEEN REDUCED AND THE SCALE THEREFORE VARIES. FULL SCALE PLANS MAY BE VIEWED AT THE MUNICIPAL OFFICE.

DRAWN BY: G.S. & S.H.
PLOT CODE: 1:1
COMPUTER FILE: REI2015D010.DWG

FILE No.: SHEET No.:
2015D010 26 OF 51

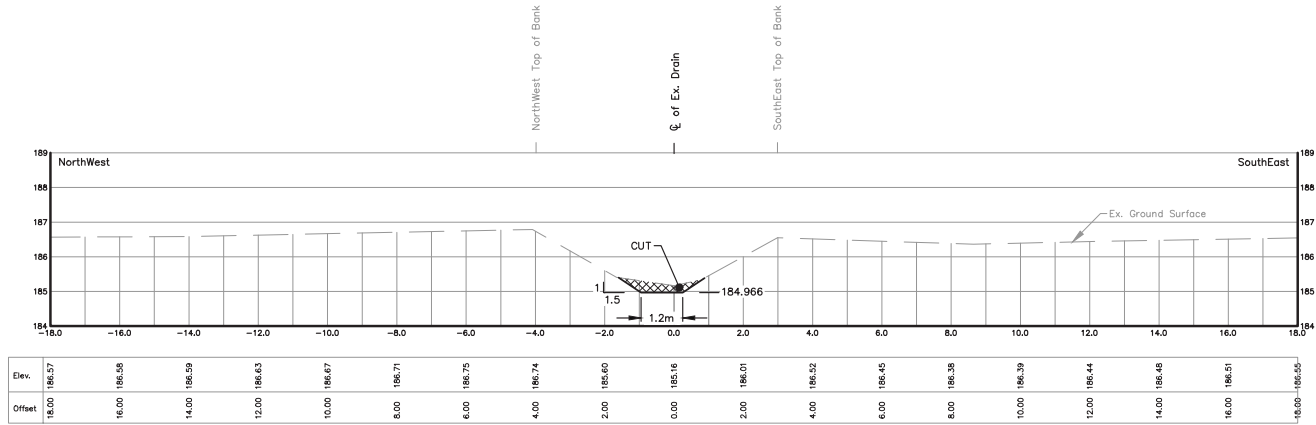

STA. 5+003.5
Scale = 1:100

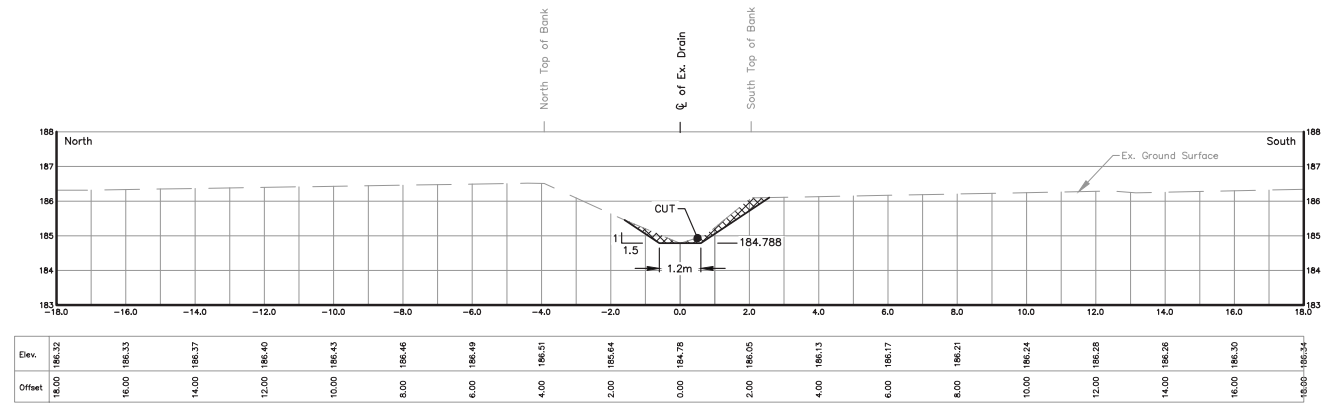

STA. 5+140.1
Scale = 1:100

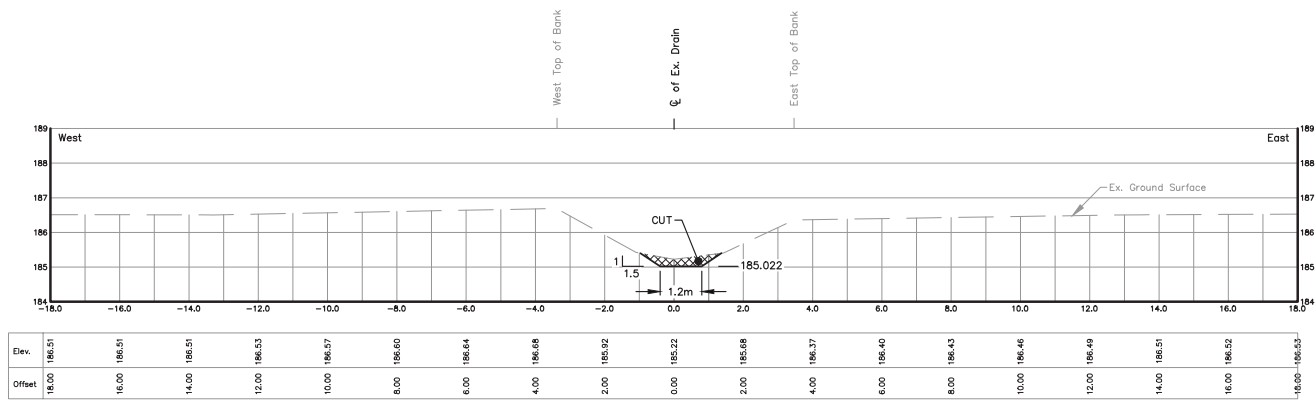

STA. 4+960.2
Scale = 1:100

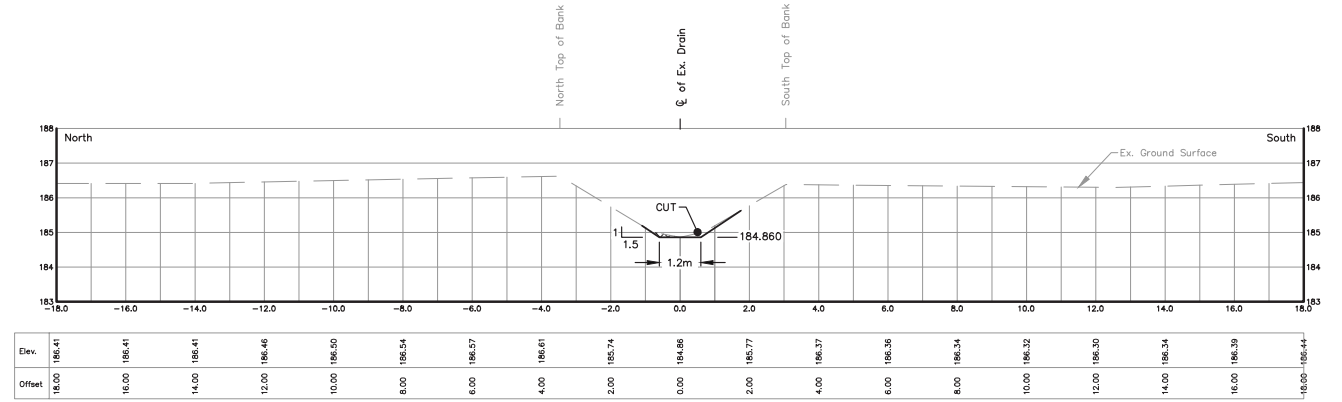

STA. 5+085.4
Scale = 1:100

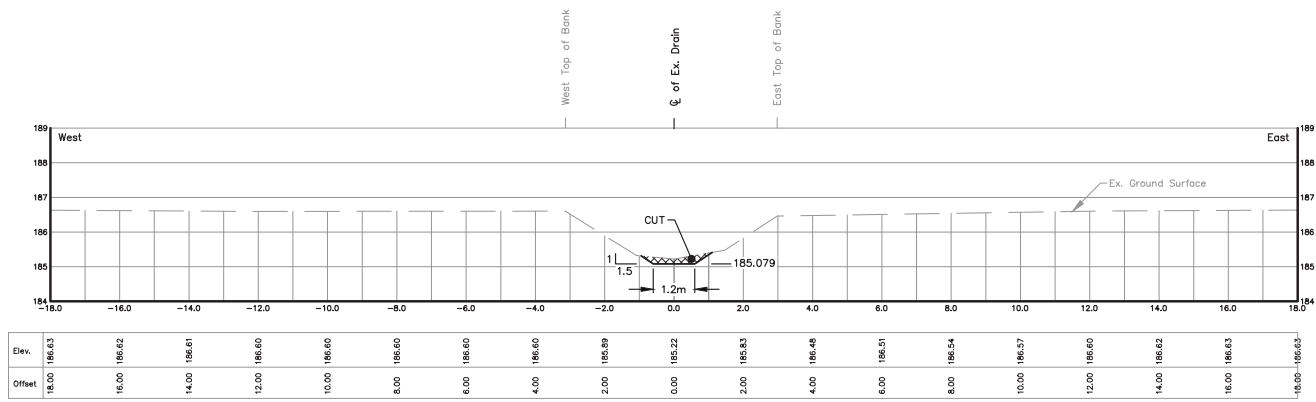

STA. 4+916.9
Scale = 1:100

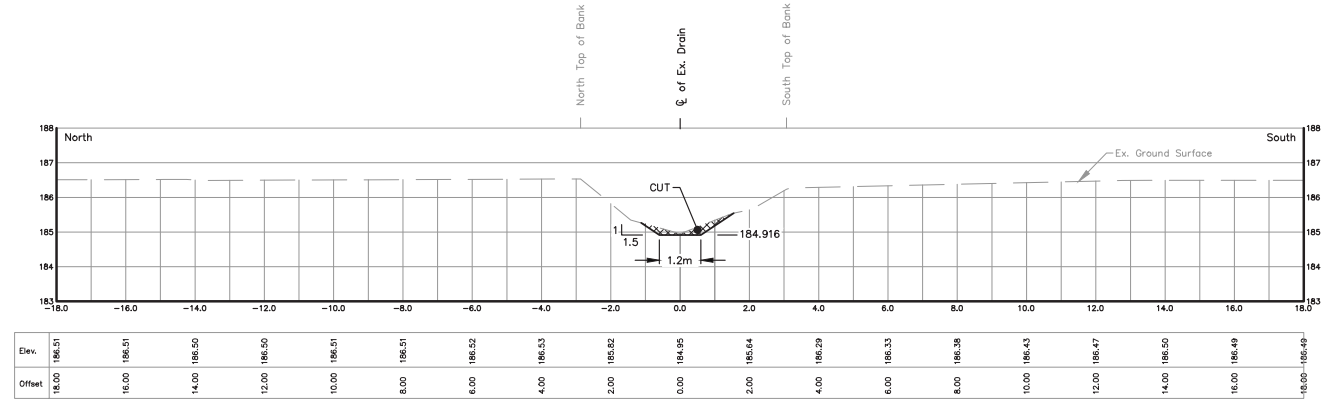

STA. 5+042.4
Scale = 1:100

THESE PLANS HAVE BEEN REDUCED AND THE SCALE THEREFORE VARIES. FULL SCALE PLANS MAY BE VIEWED AT THE MUNICIPAL OFFICE.

DRAWN BY: G.S. & S.H.
PLOT CODE: 1:1
COMPUTER FILE: REI2015D010.DWG

FILE No.: SHEET No.:
2015D010 27 OF 51

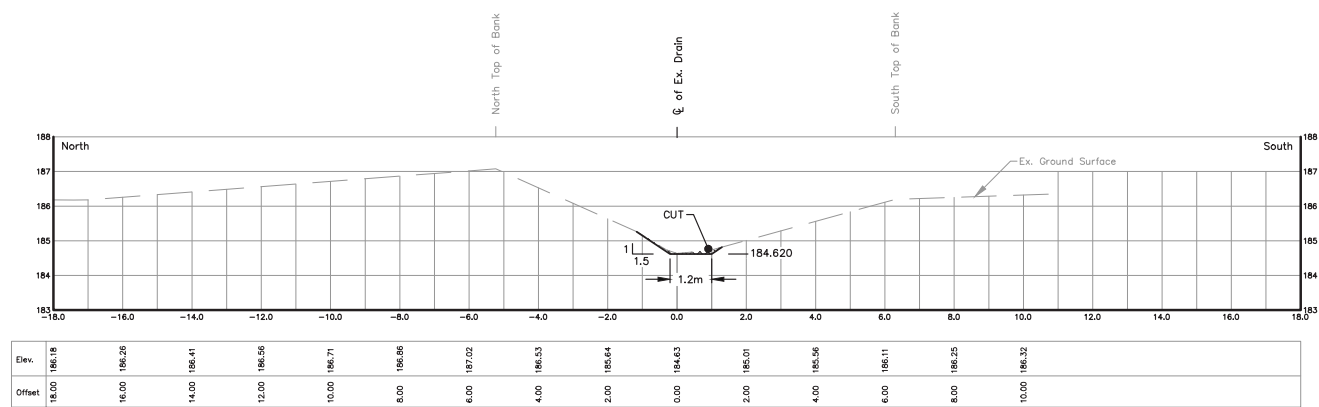

STA. 5+269.6
Scale = 1:100

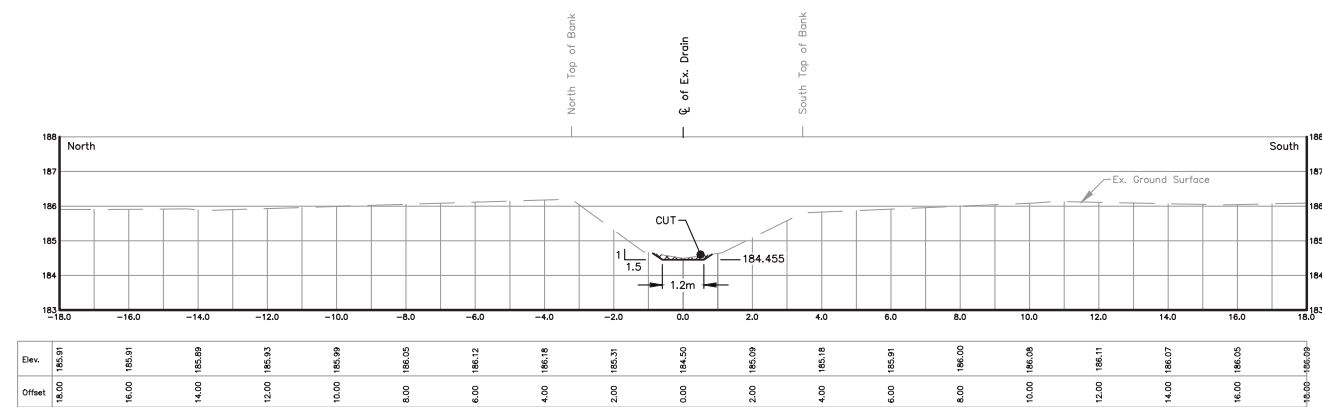

STA. 5+396.6
Scale = 1:100

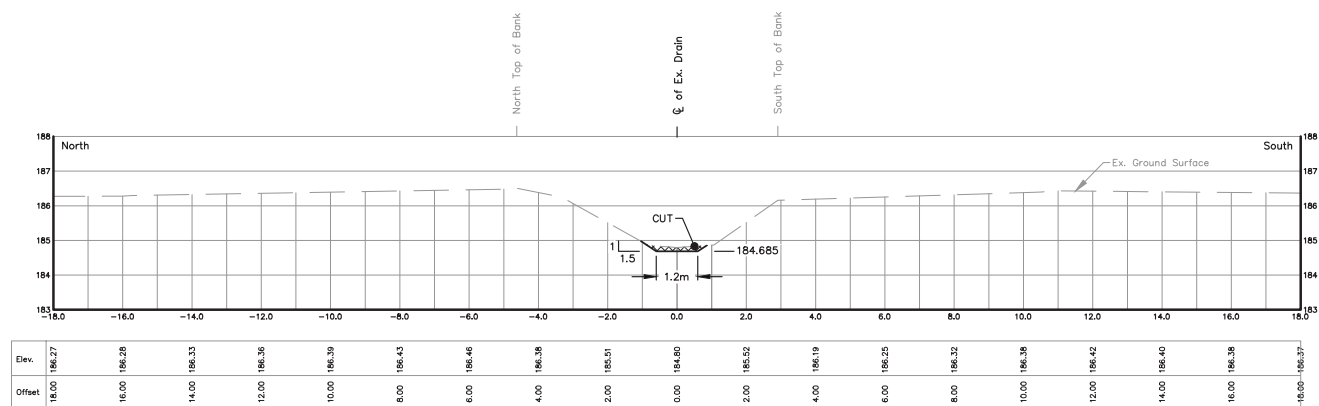

STA. 5+219.3
Scale = 1:100

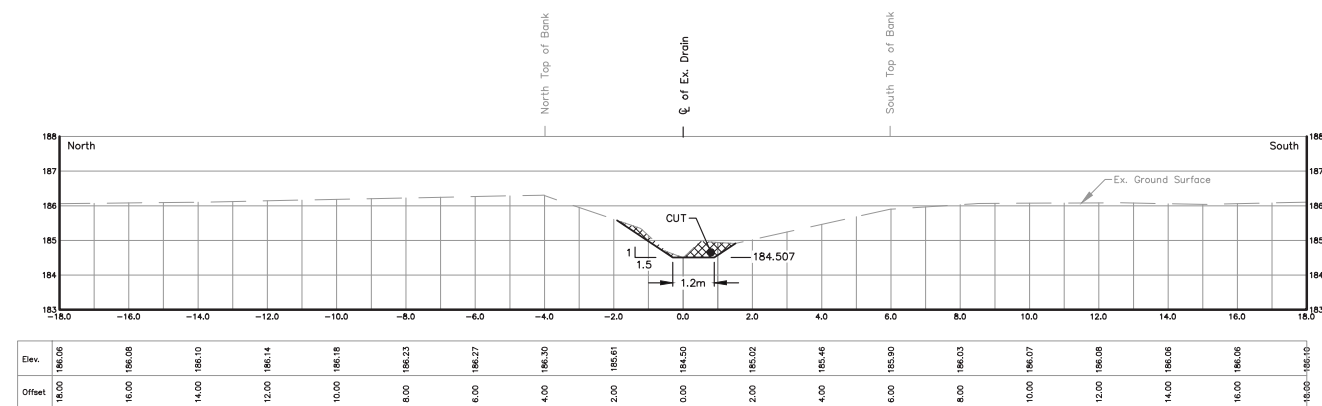

STA. 5+356.7
Scale = 1:100

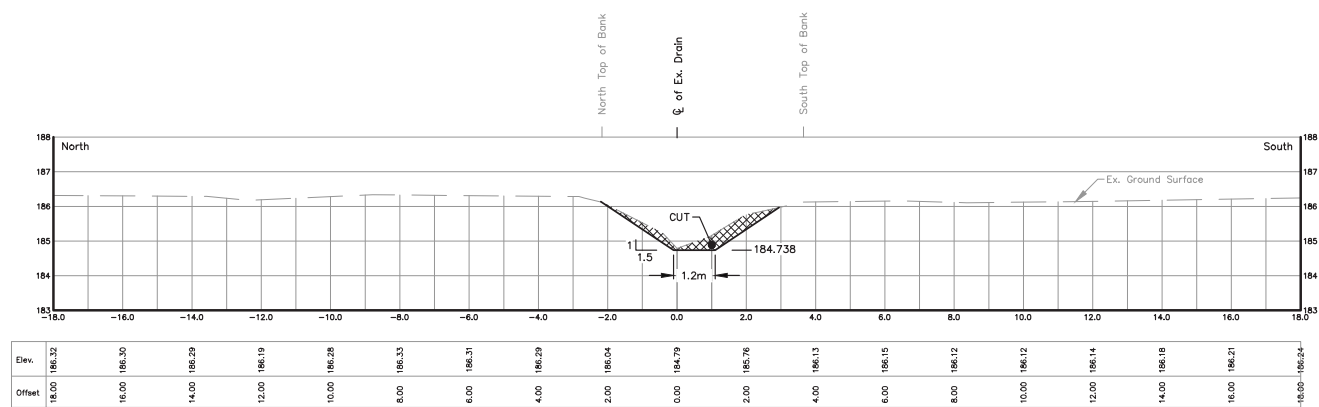

STA. 5+179.1
Scale = 1:100

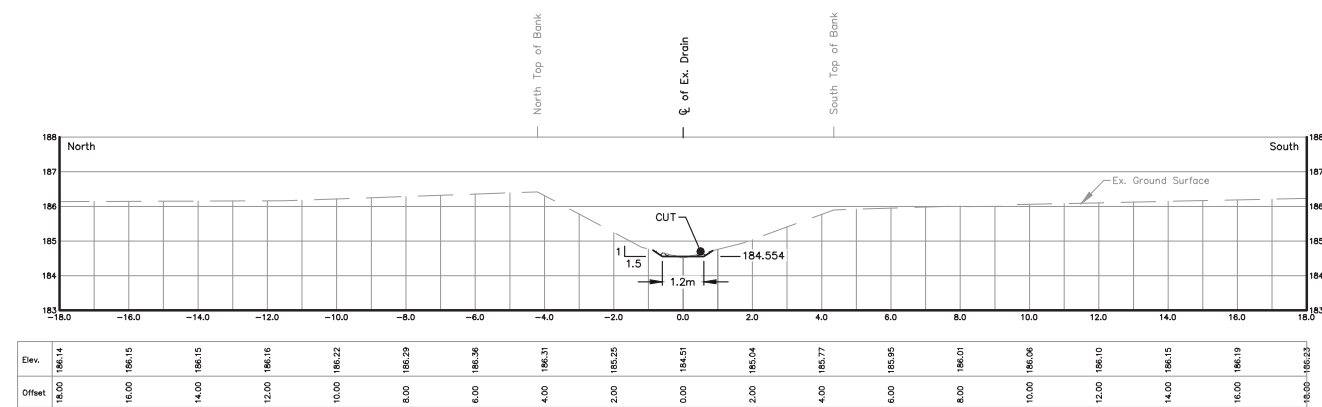

STA. 5+320.7
Scale = 1:100

THESE PLANS HAVE BEEN REDUCED
AND THE SCALE THEREFORE VARIES.
FULL SCALE PLANS MAY BE VIEWED
AT THE MUNICIPAL OFFICE.

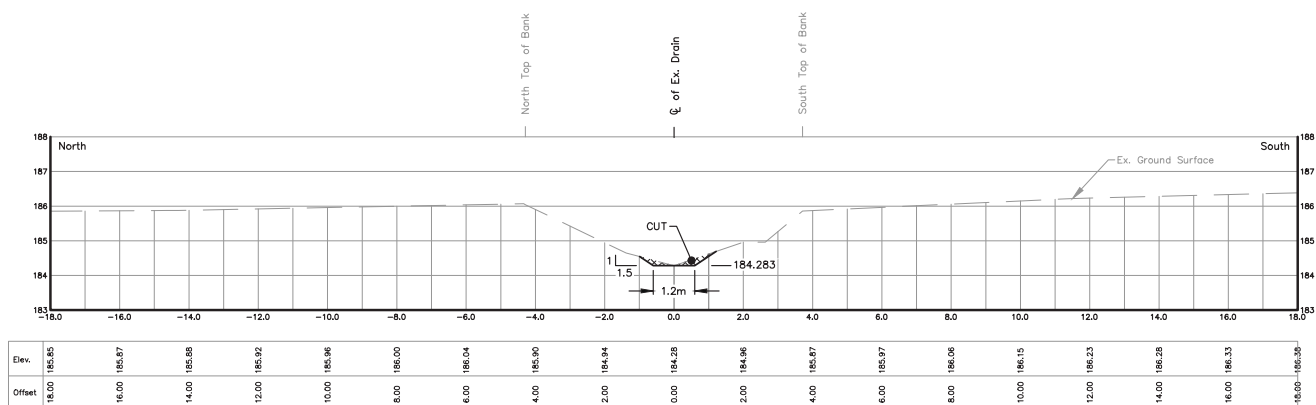

STA. 5+528.6
Scale = 1:100

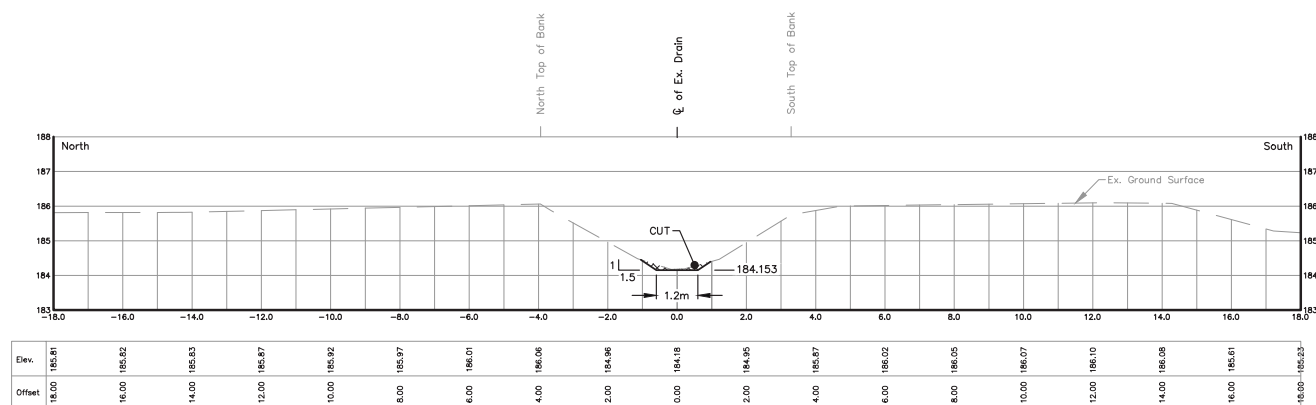

STA. 5+628.7
Scale = 1:100

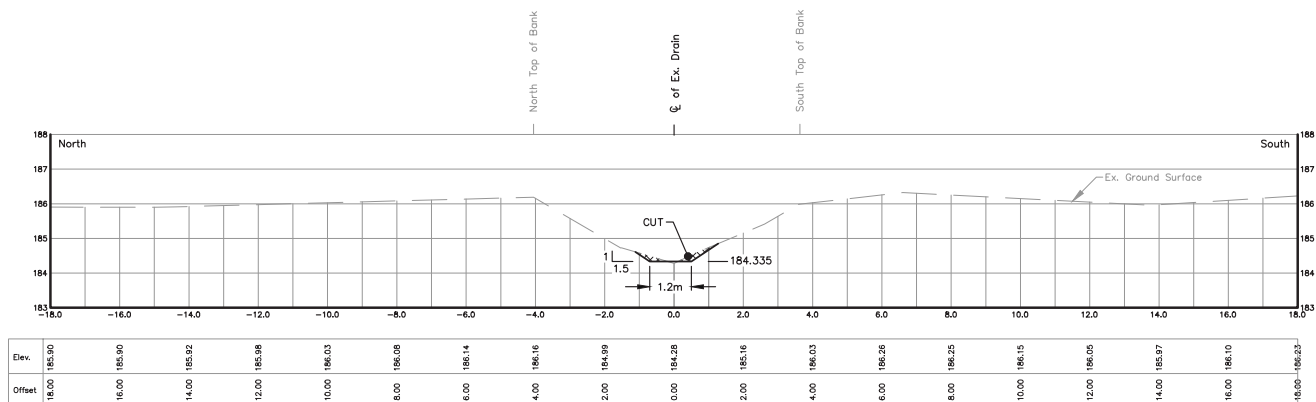

STA. 5+488.7
Scale = 1:100

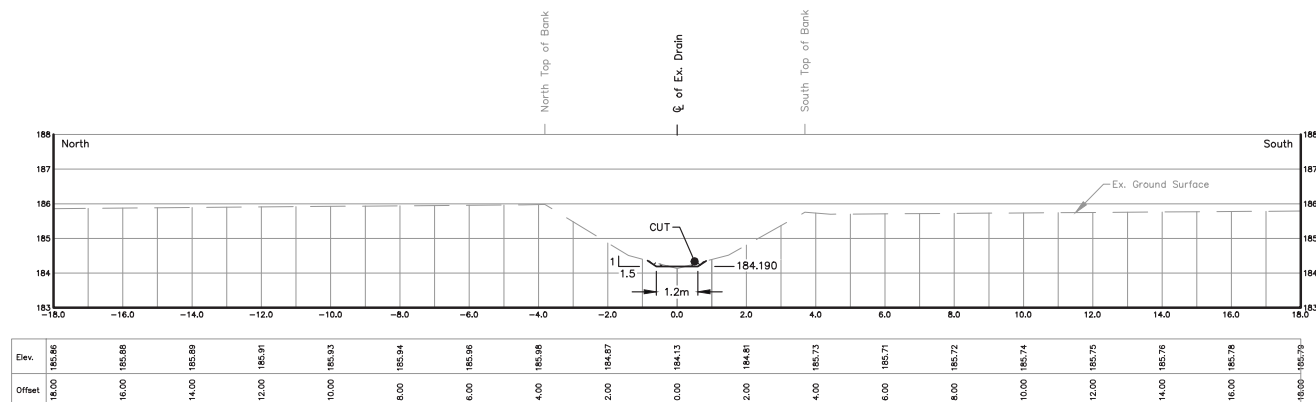

STA. 5+599.9
Scale = 1:100

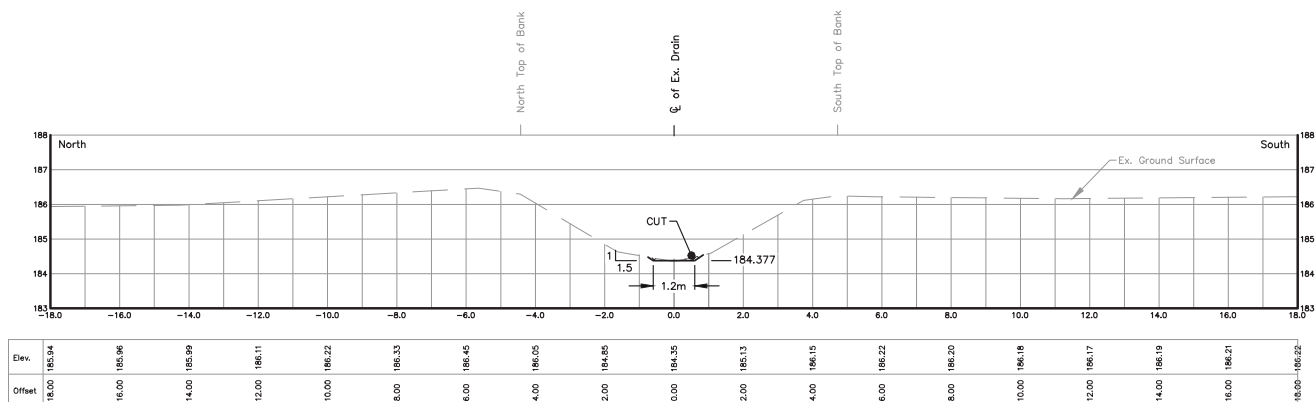

STA. 5+456.7
Scale = 1:100

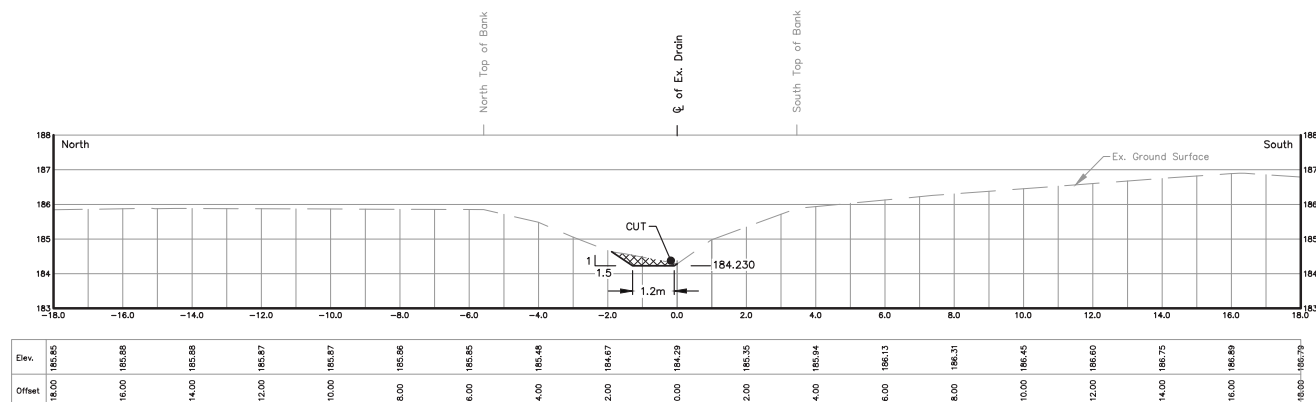

STA. 5+569.4
Scale = 1:100

THESE PLANS HAVE BEEN REDUCED AND THE SCALE THEREFORE VARIES. FULL SCALE PLANS MAY BE VIEWED AT THE MUNICIPAL OFFICE.

DRAWN BY: G.S. & S.H.
PLOT CODE: 1:1
COMPUTER FILE: REI2015D010.DWG
FILE No.: SHEET No.:
2015D010 29 OF 51

16

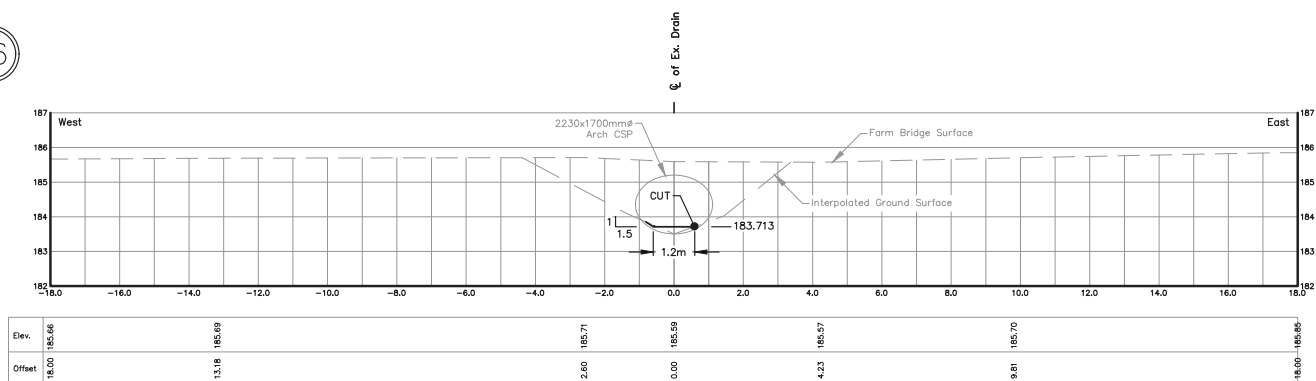

STA. 5+994.0
Scale = 1:100

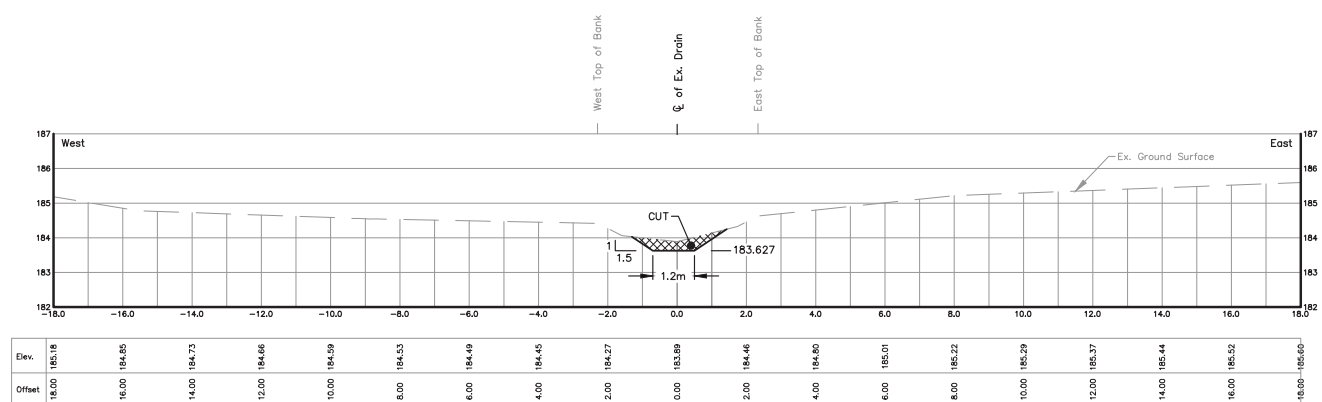

STA. 6+066.6
Scale = 1:100

16

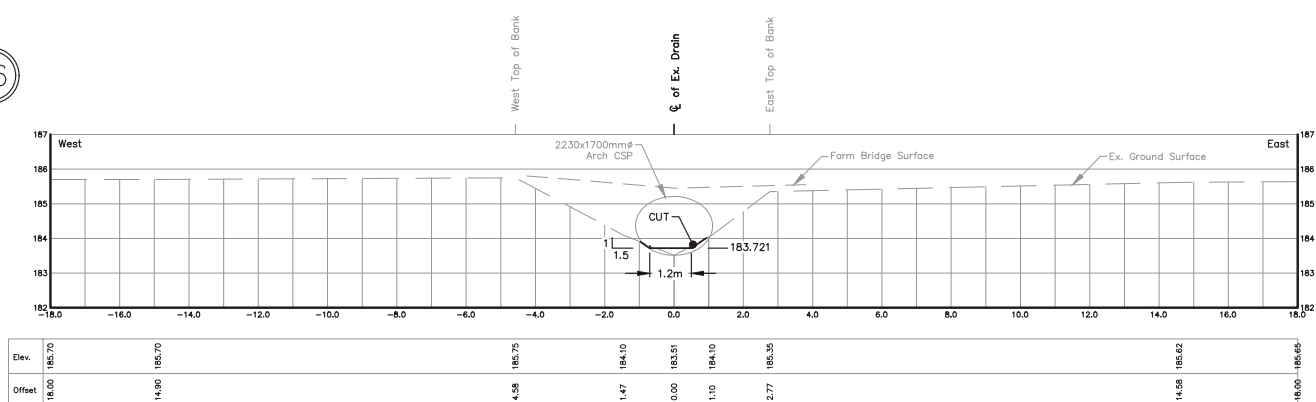

STA. 5+987.4
Scale = 1:100

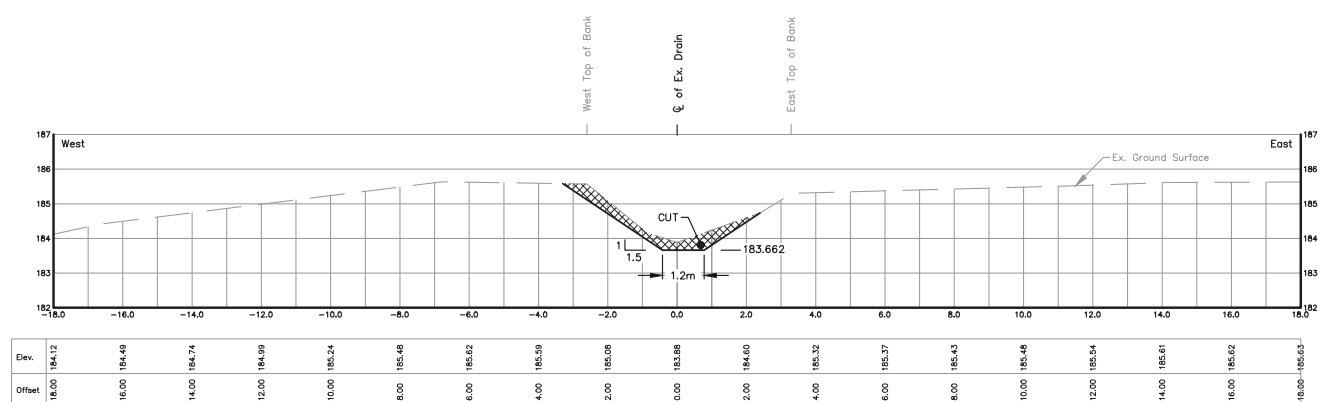

STA. 6+037.4
Scale = 1:100

16

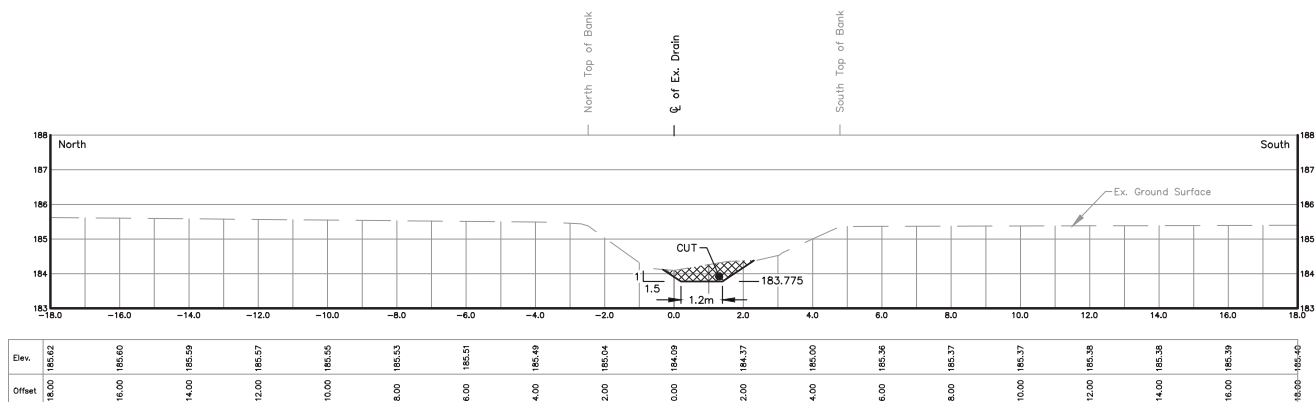

STA. 5+941.9
Scale = 1:100

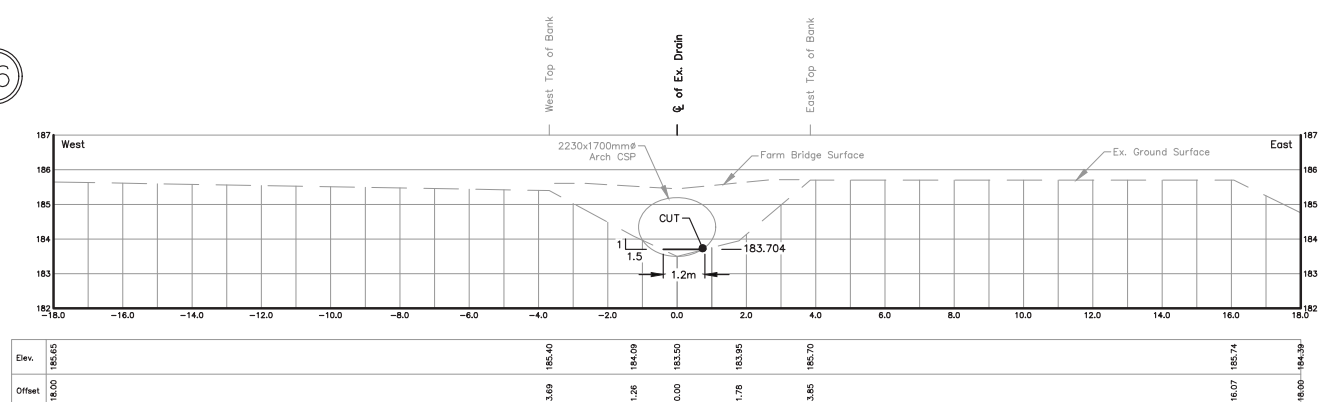

STA. 6+001.4
Scale = 1:100

THESE PLANS HAVE BEEN REDUCED AND THE SCALE THEREFORE VARIES. FULL SCALE PLANS MAY BE VIEWED AT THE MUNICIPAL OFFICE.

C:\Users\John\Desktop\REI-2015D010 - Sullivan Creek Drain\REI2015D010 - Sections B.dwg 2021-05-16

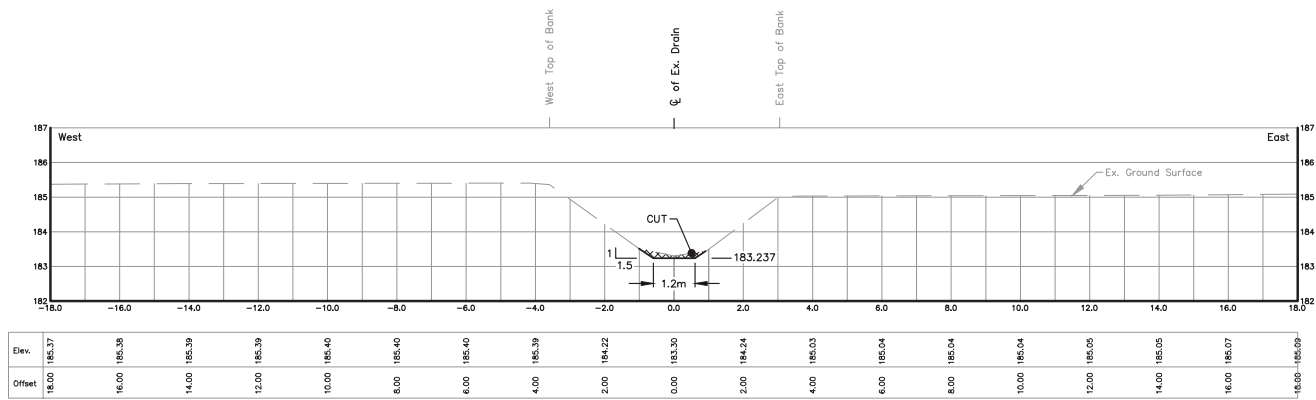

STA. 6+396.3
Scale = 1:100

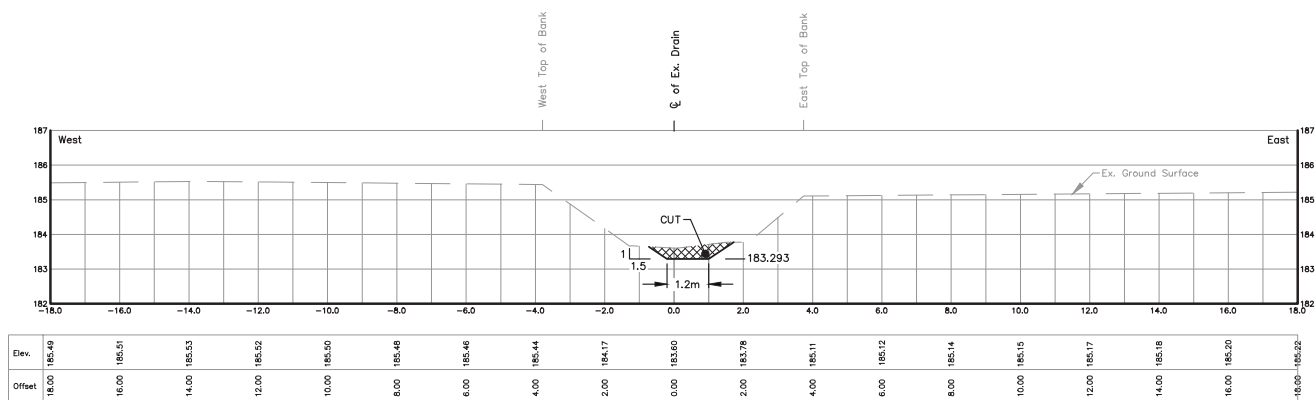

STA. 6+348.6
Scale = 1:100

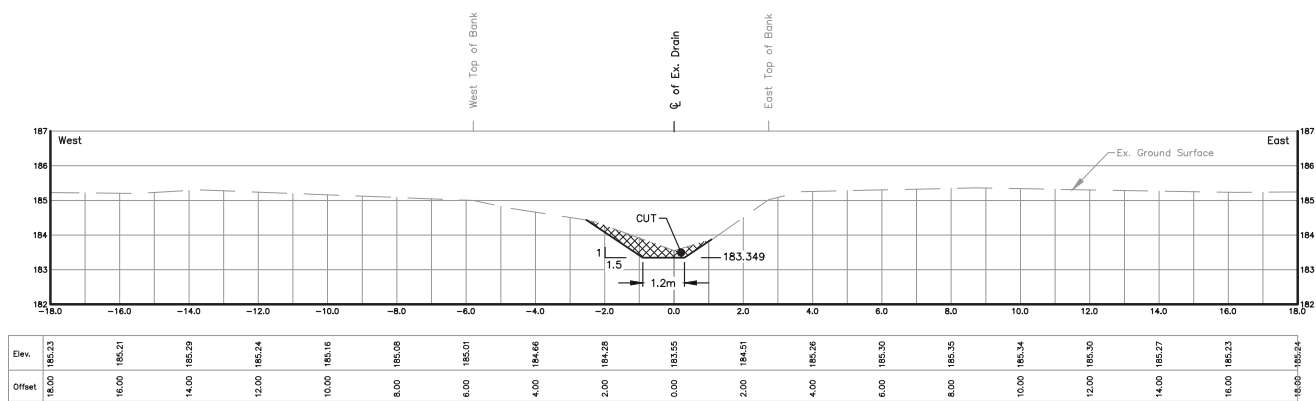

STA. 6+301.4
Scale = 1:100

18

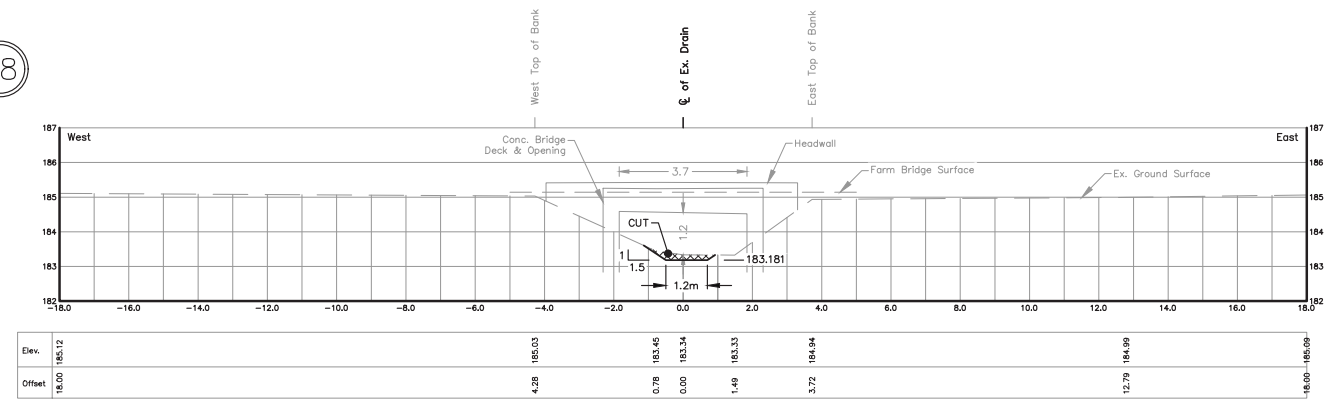

STA. 6+443.4
Scale = 1:100

18

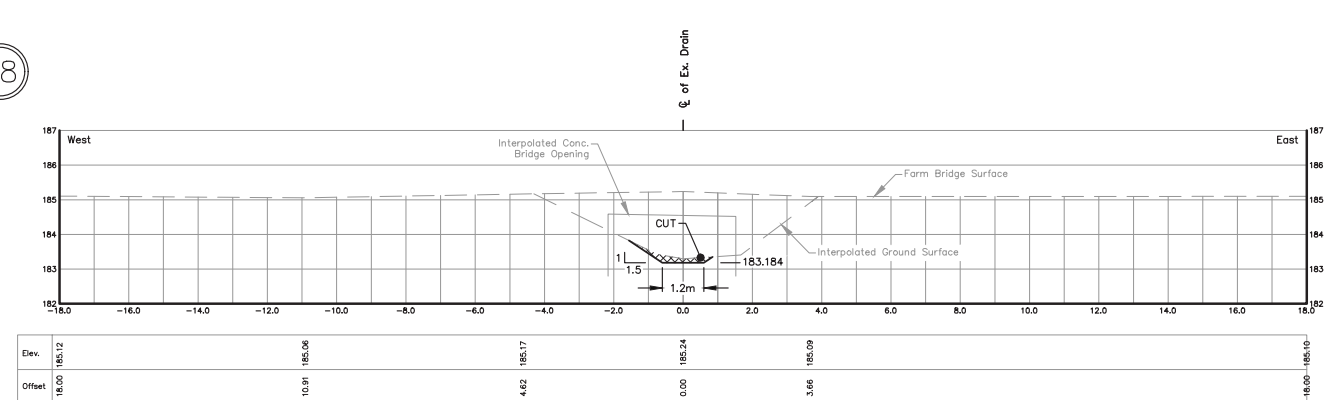

STA. 6+440.9
Scale = 1:100

18

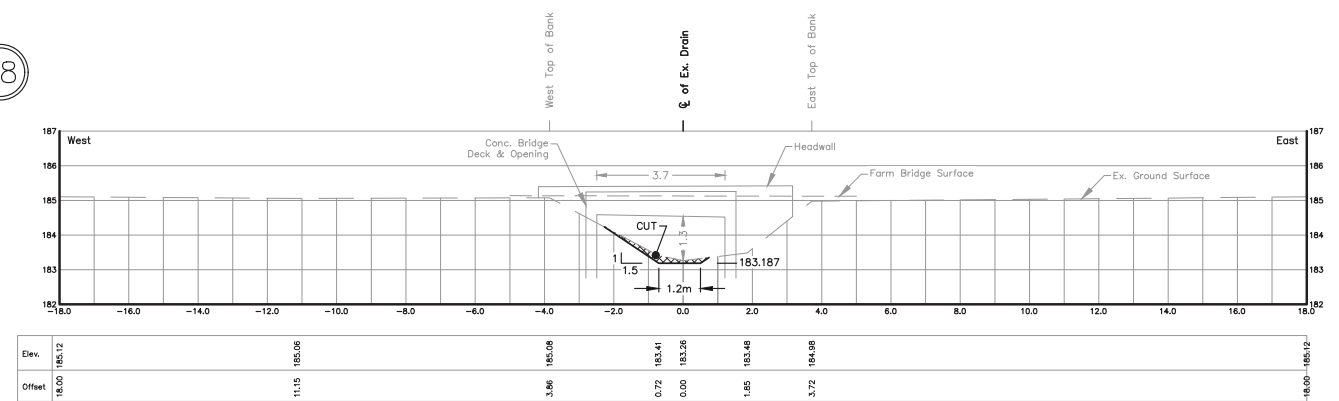

STA. 6+438.5
Scale = 1:100

THESE PLANS HAVE BEEN REDUCED
AND THE SCALE THEREFORE VARIES.
FULL SCALE PLANS MAY BE VIEWED
AT THE MUNICIPAL OFFICE.

DRAWN BY: G.S. & S.H.
PLOT CODE: 1:1
COMPUTER FILE: REI2015D010.DWG
FILE No.: 2015D010 SHEET No.: 33 OF 51

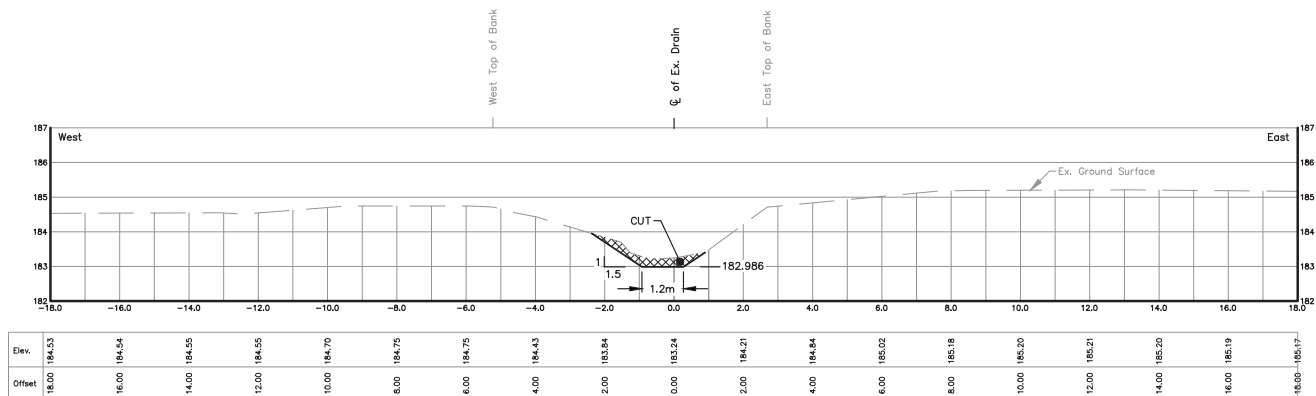

STA 6+607.4
Scale = 1:100

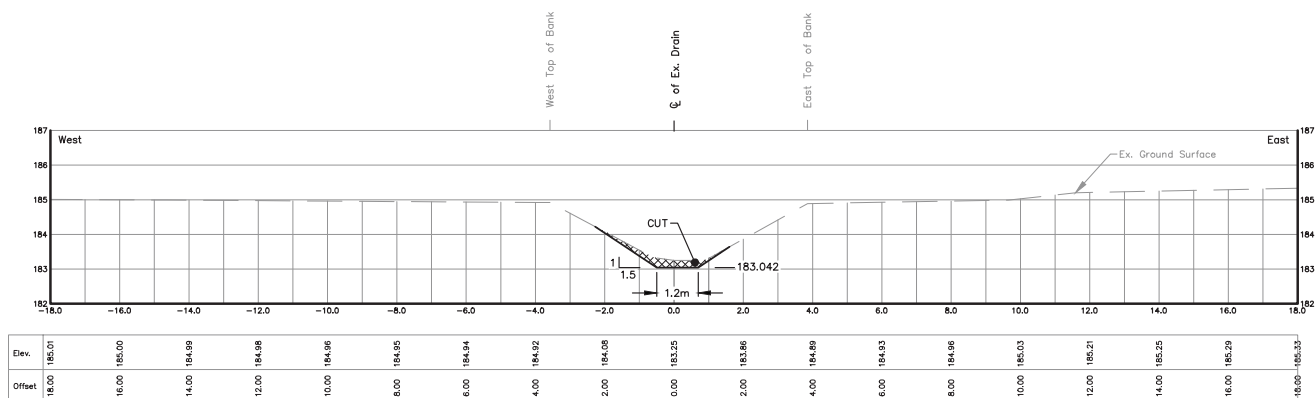

STA 6+580.5
Scale = 1:100

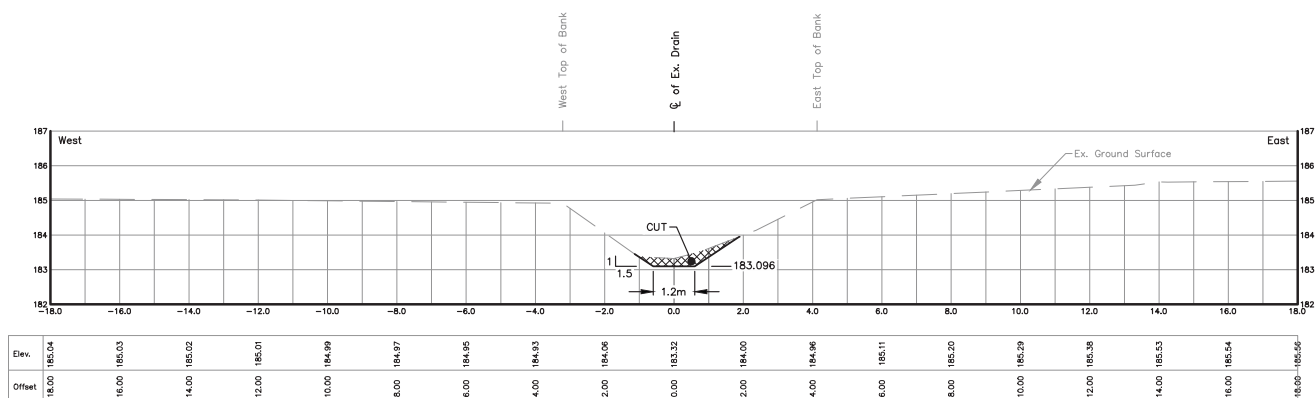

STA 6+514.9
Scale = 1:100

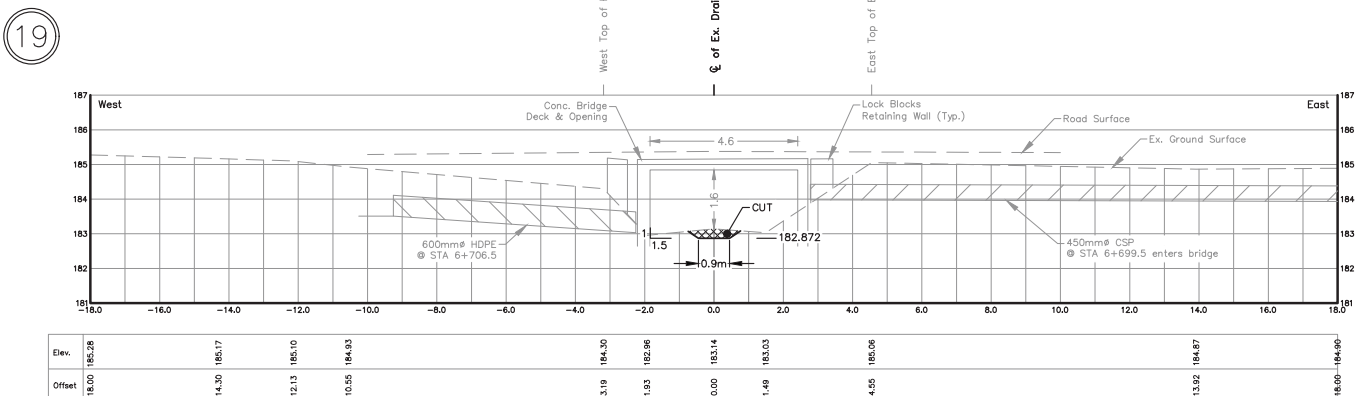

STA 6+709.1
Scale = 1:100

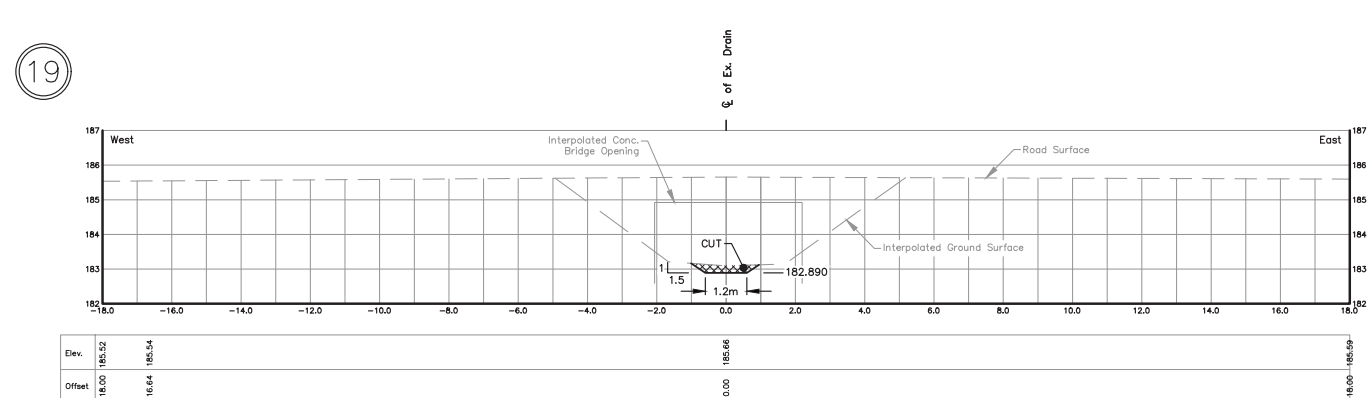

STA 6+889.0
Scale = 1:100

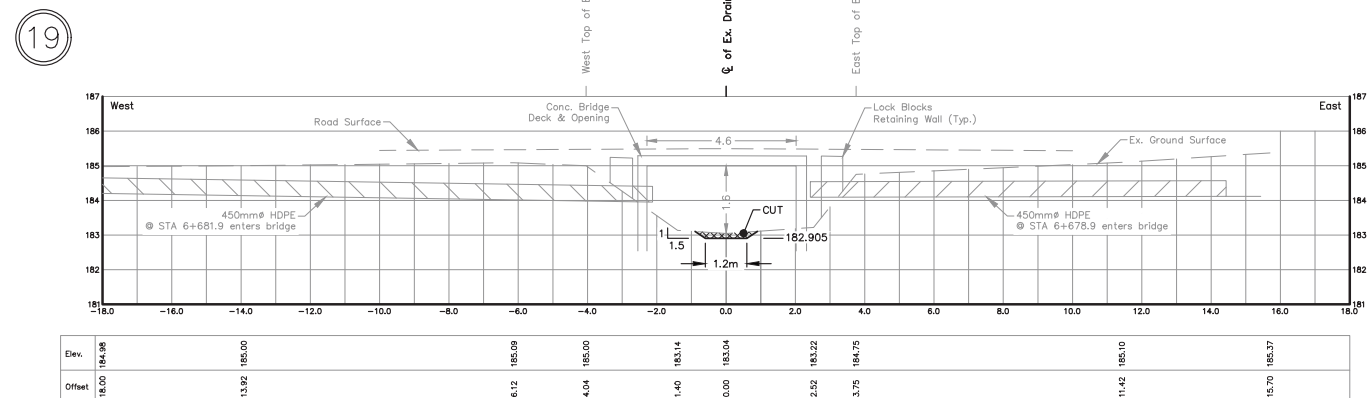

STA 6+676.3
Scale = 1:100

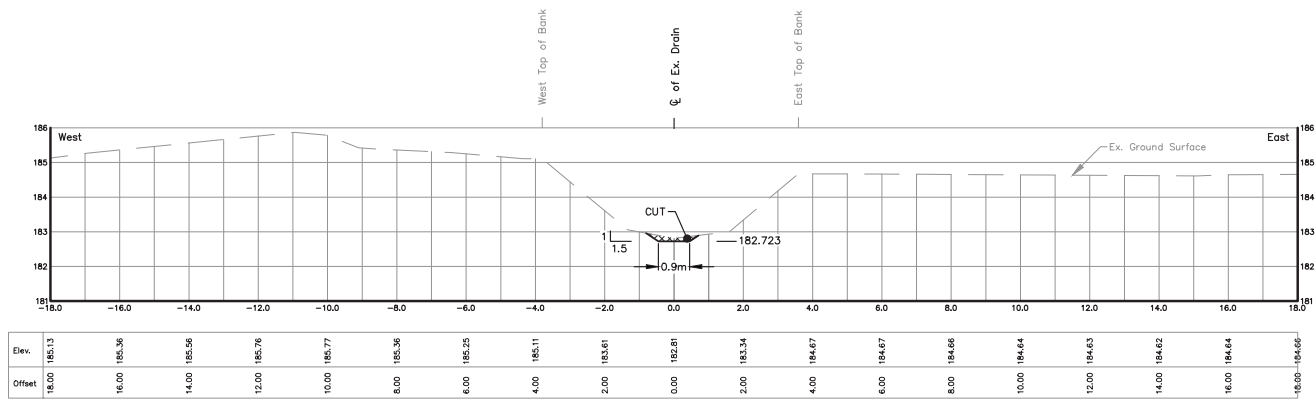

STA 6+830.1
Scale = 1:100

20

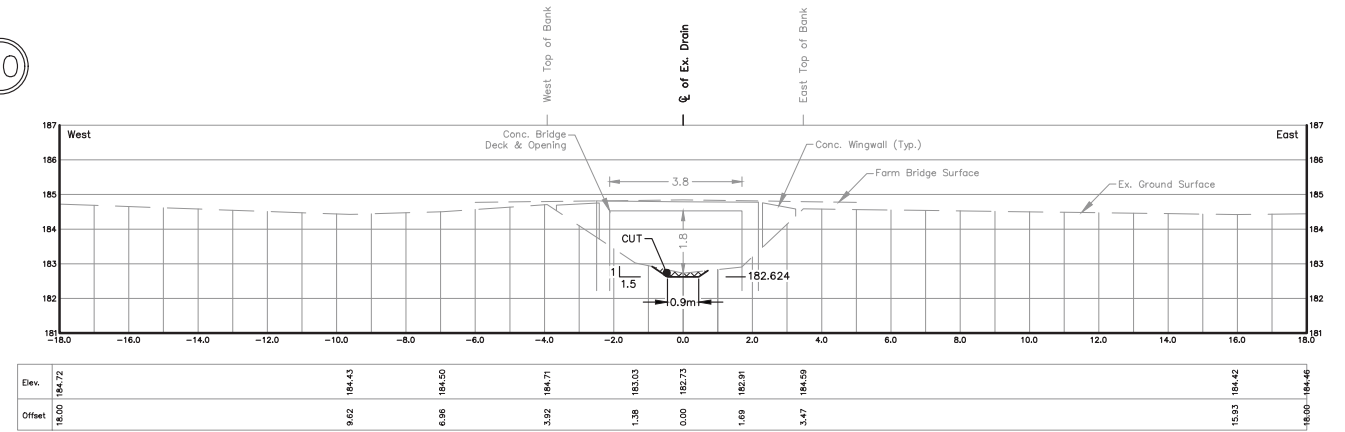

STA 6+913.4
Scale = 1:100

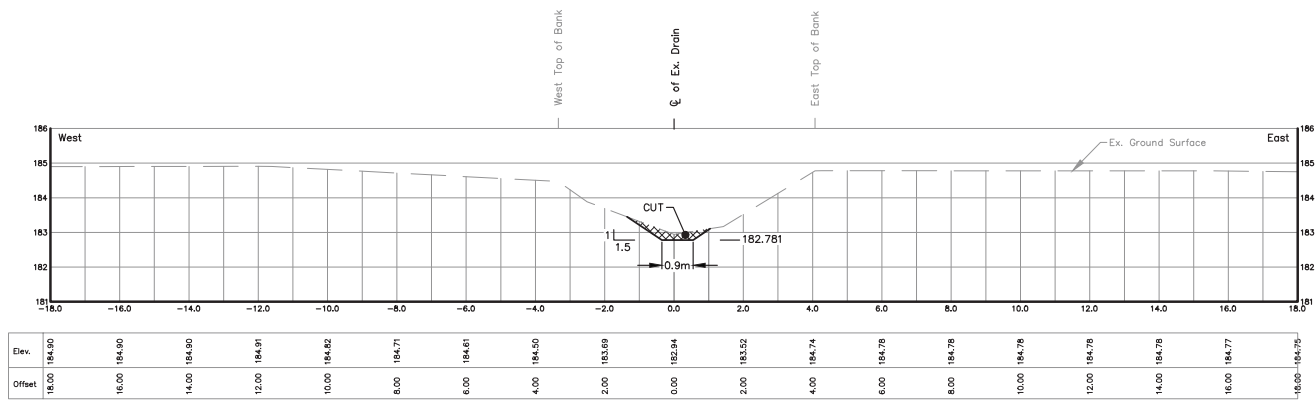

STA 6+781.0
Scale = 1:100

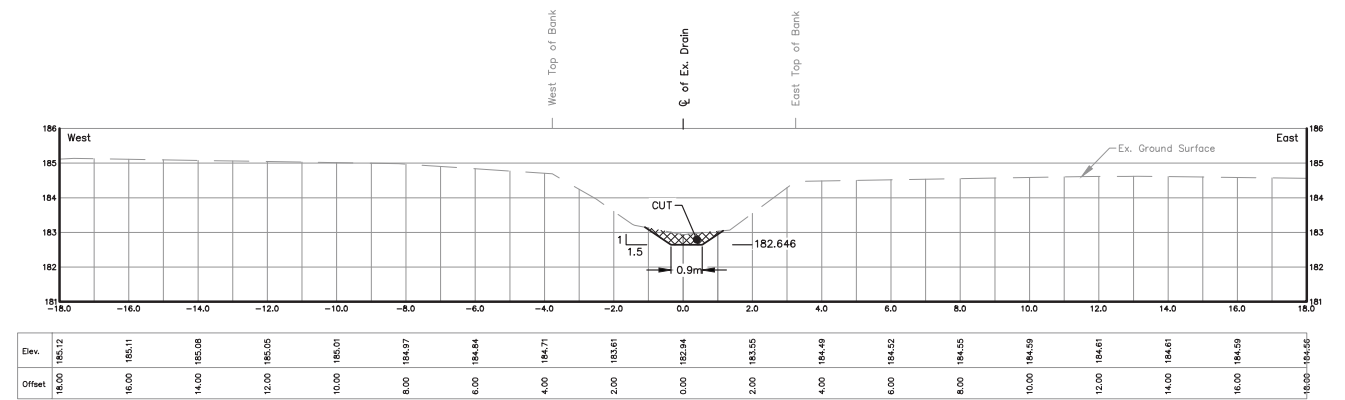

STA 6+895.5
Scale = 1:100

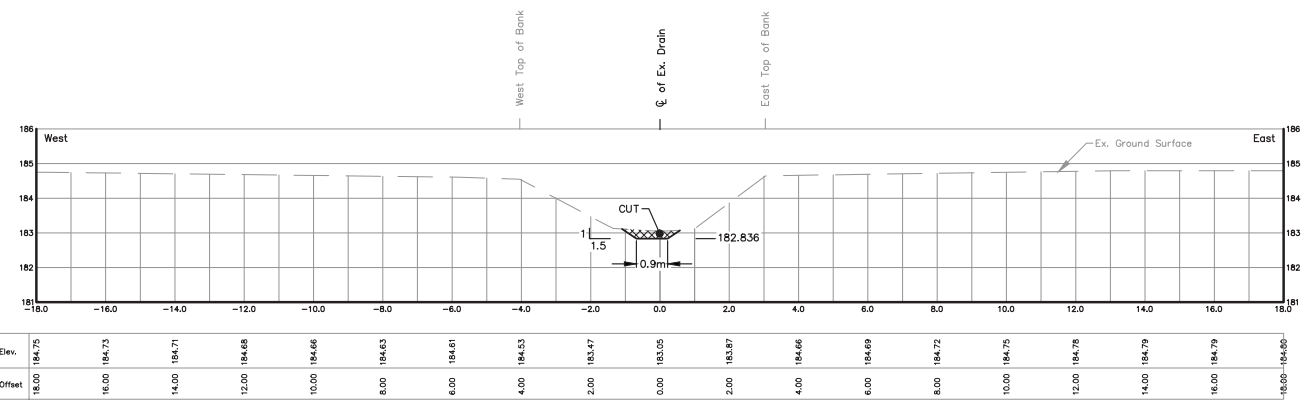

STA 6+734.1
Scale = 1:100

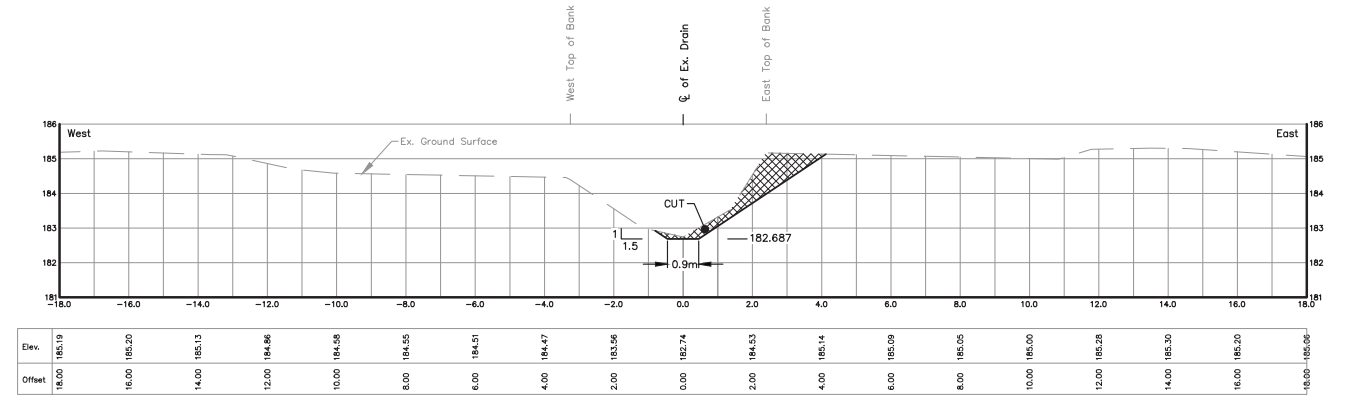

STA 6+860.0
Scale = 1:100

THESE PLANS HAVE BEEN REDUCED AND THE SCALE THEREFORE VARIES. FULL SCALE PLANS MAY BE VIEWED AT THE MUNICIPAL OFFICE.

DRAWN BY: G.S. & S.H.
PLOT CODE: 1:1
COMPUTER FILE: REI2015D010.DWG
FILE No.: 2015D010 SHEET No.: 35 OF 51

SERVER:2015\REI Data Server\PROJECTS\PROJECTS\2015\REI-2015D010 - Sullivan Creek Drain\Map\REI2015D010 - Sections B.dwg 2022-02-28

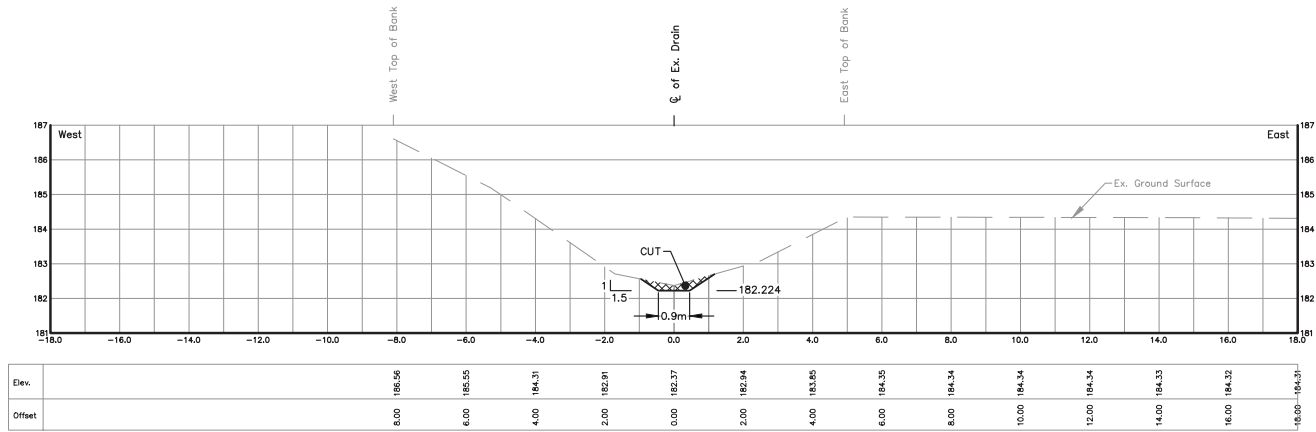

STA 7+2516
Scale = 1:100

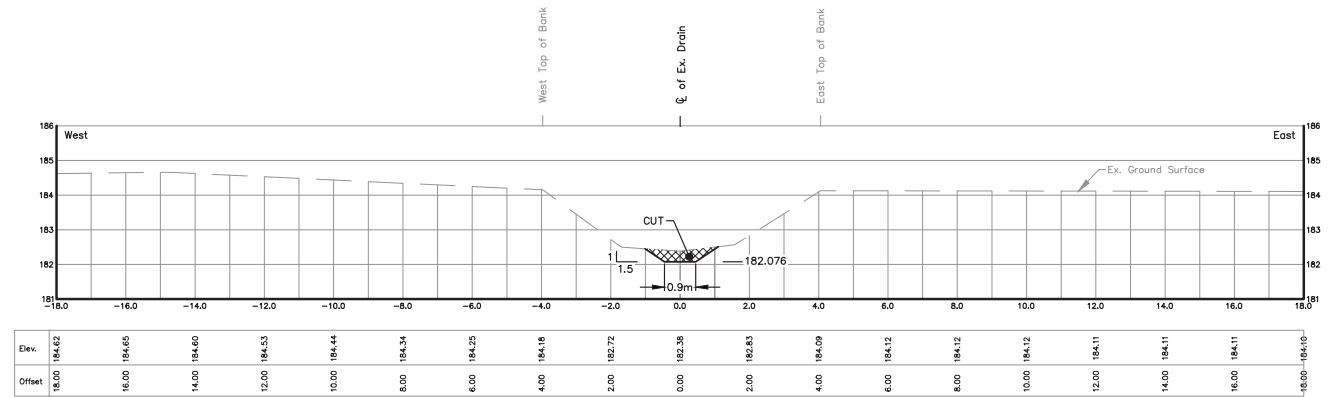

STA 7+3764
Scale = 1:100

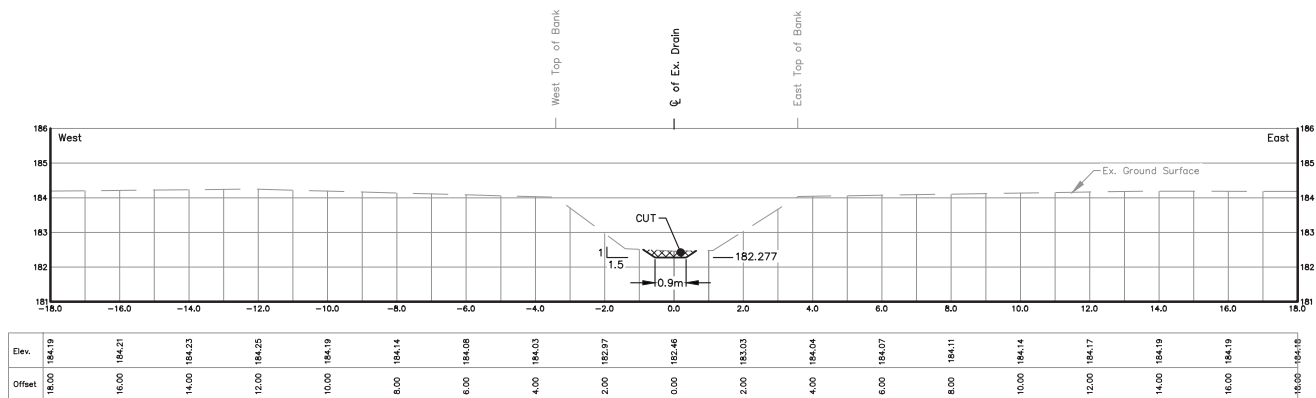

STA 7+2062
Scale = 1:100

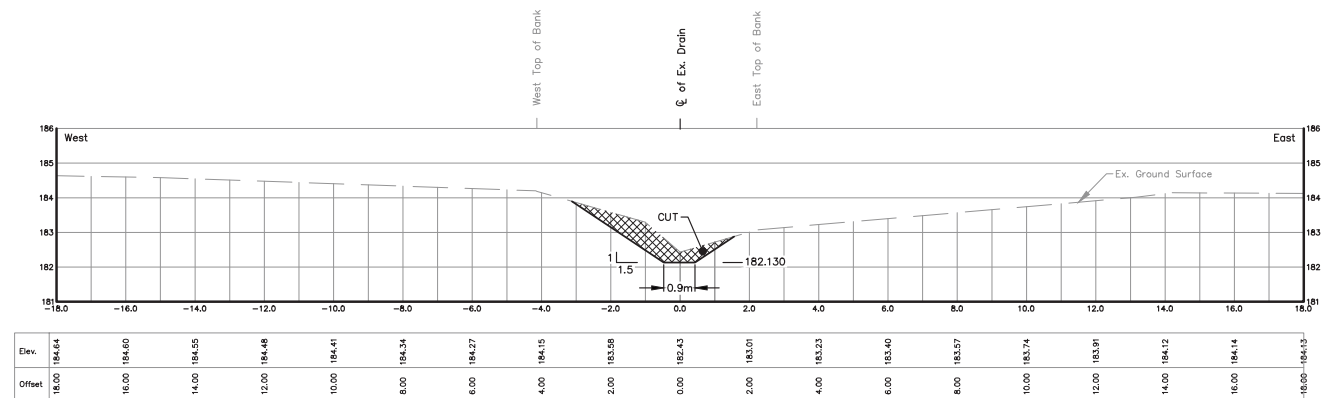

STA 7+3303
Scale = 1:100

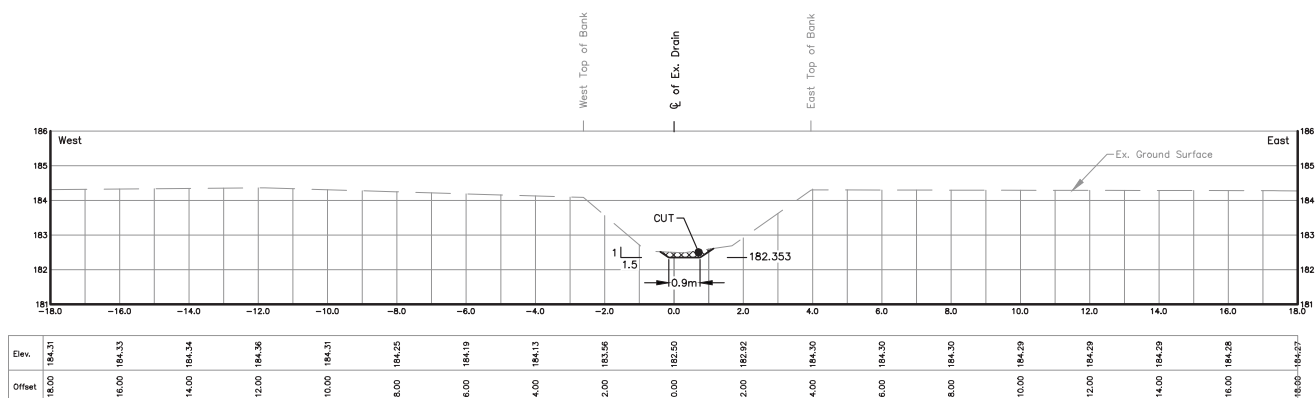

STA 7+1422
Scale = 1:100

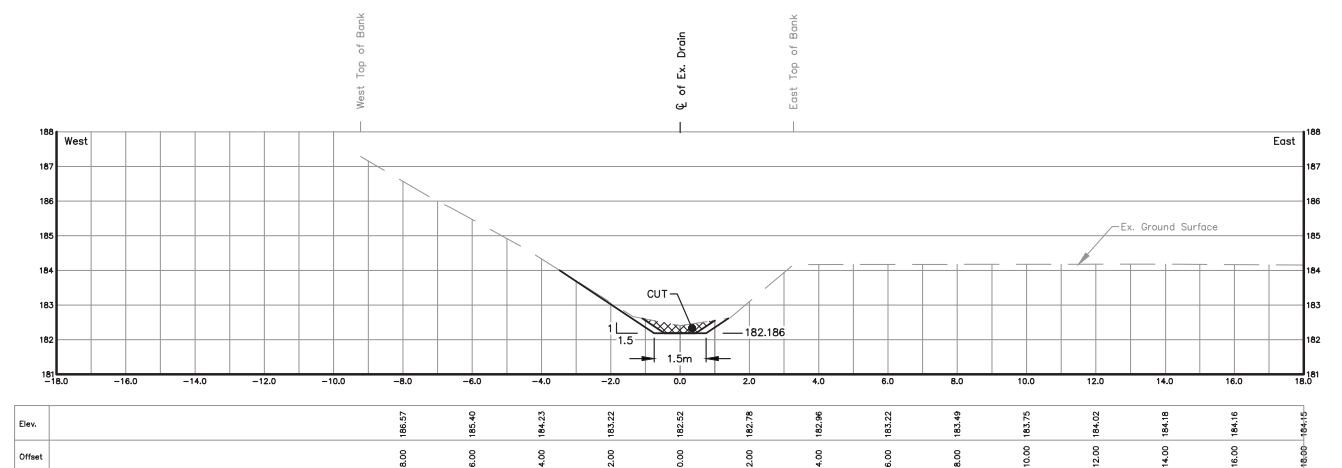

STA 7+2832
Scale = 1:100

THESE PLANS HAVE BEEN REDUCED AND THE SCALE THEREFORE VARIES. FULL SCALE PLANS MAY BE VIEWED AT THE MUNICIPAL OFFICE.

DRAWN BY: G.S. & S.H.
PLOT CODE: 1:1
COMPUTER FILE: REI2015D010.DWG
FILE No.: SHEET No.:
2015D010 37 OF 51

SERVER:2015\REI Data Server\DRAGTIN\PROJECTS\Projects 2015\REI-2015D010 - Sultan Creek Drain\Draw\REI2015D010 - Sections B.dwg 2022-02-28

21

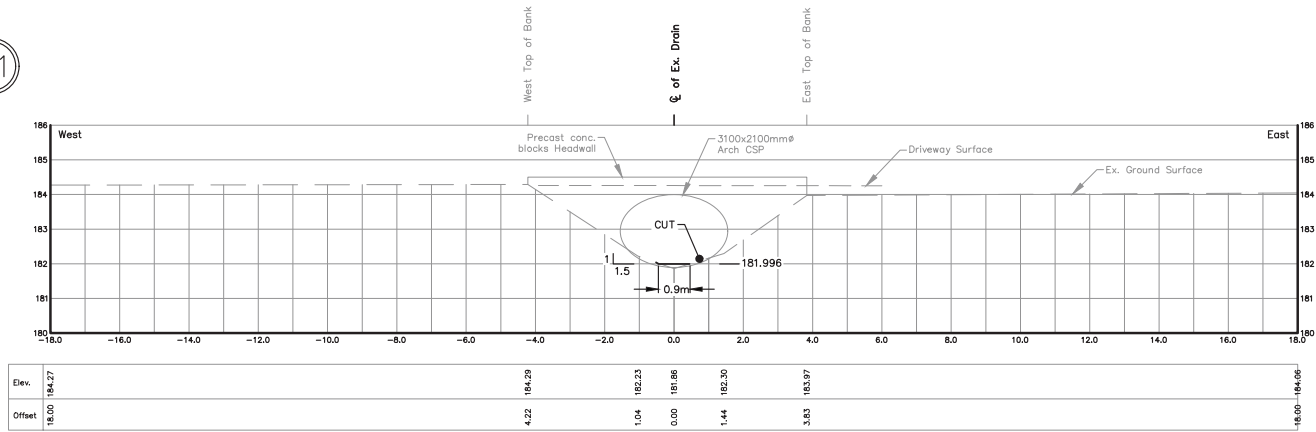

STA 7+4440
Scale = 1:100

21

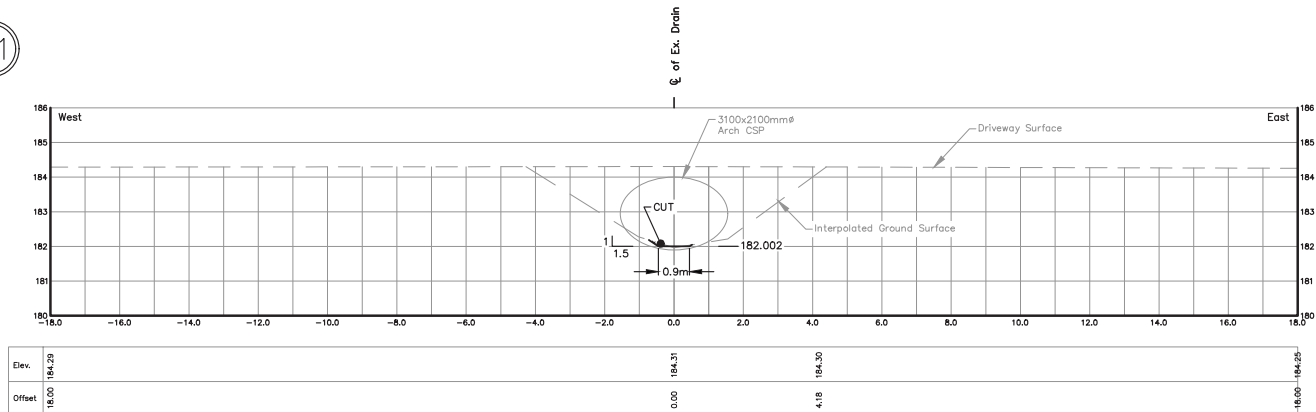

STA 7+438.5
Scale = 1:100

21

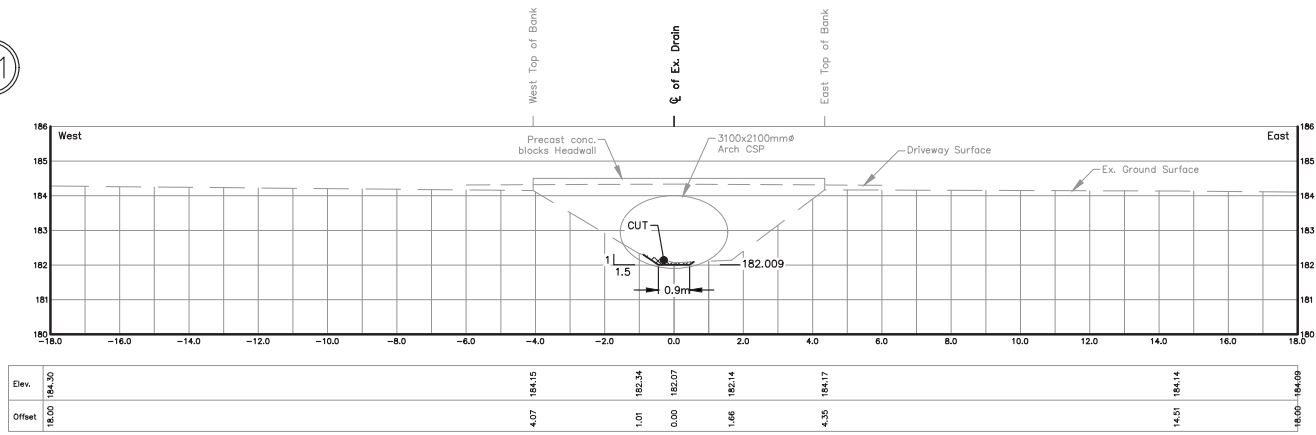

STA 7+433.0
Scale = 1:100

0
5
10
15
20
25
30
35
40
45
50
55
60
65
70
75
80
85
90
95
100

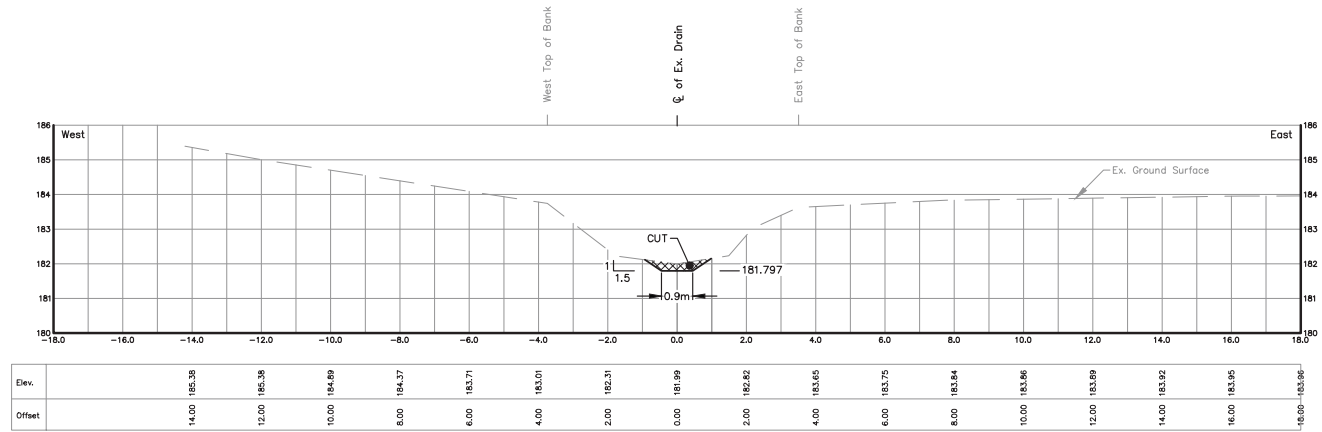

STA 7+612.0
Scale = 1:100

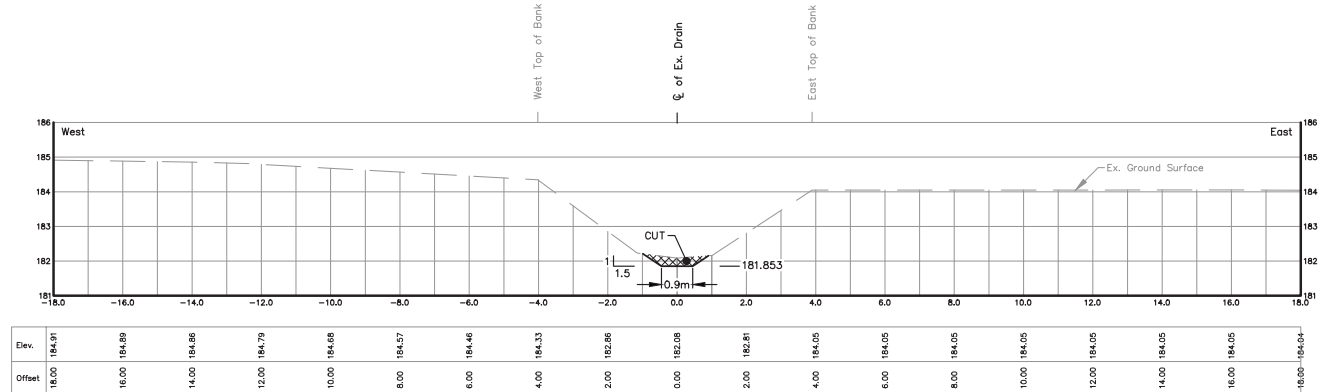

STA 7+564.8
Scale = 1:100

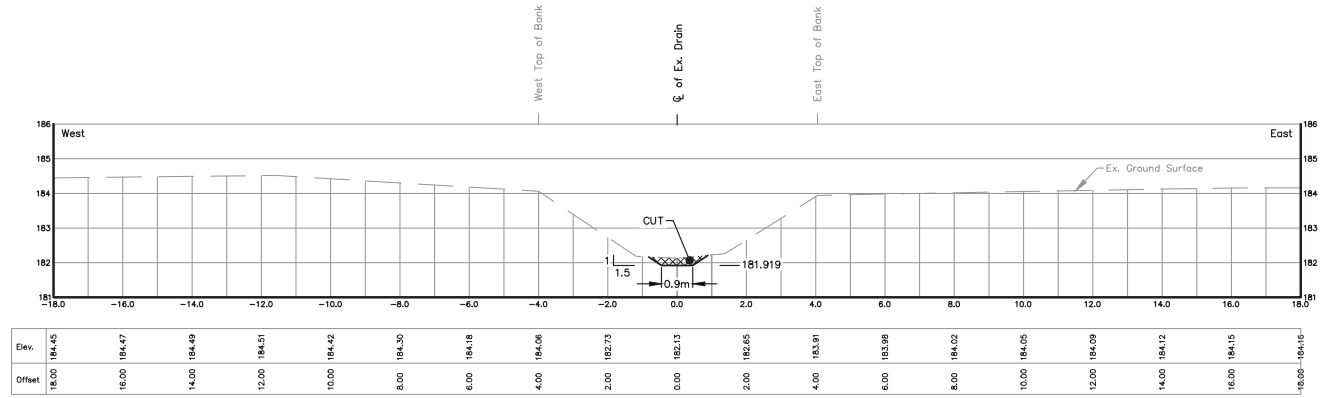

STA 7+509.2
Scale = 1:100

THESE PLANS HAVE BEEN REDUCED AND THE SCALE THEREFORE VARIES FULL SCALE PLANS MAY BE VIEWED AT THE MUNICIPAL OFFICE.

DRAWN BY: G.S. & S.H.
PLOT CODE: 1:1
COMPUTER FILE: REI2015D010.DWG
FILE No.: 2015D010
SHEET No.: 38 OF 51

SERVER: 2015\REI Data Server\PROJECTS\PROJECTS\2015\REI-2015D010 - Sultan Creek Drain\Draw\REI2015D010 - Sections B.dwg 2022-02-28

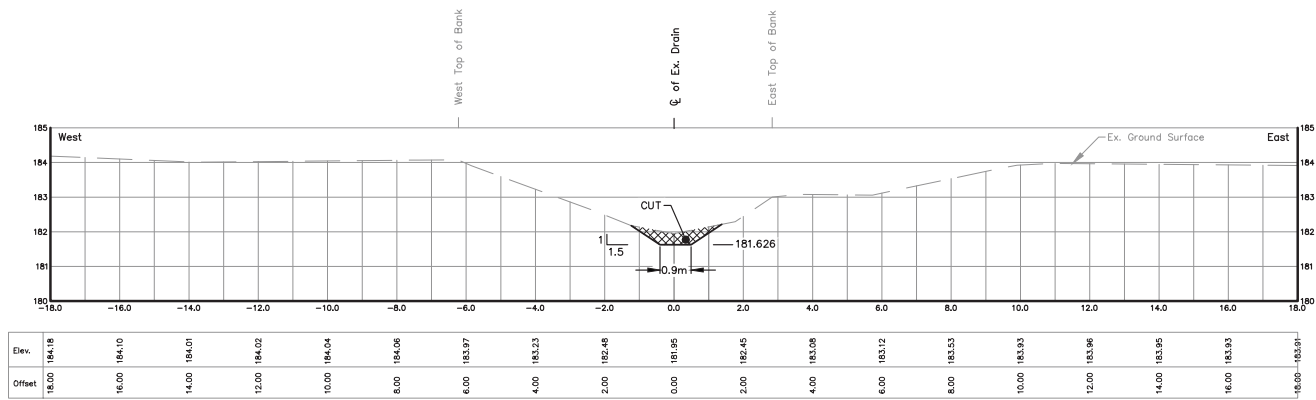

STA 7-7560
Scale = 1:100

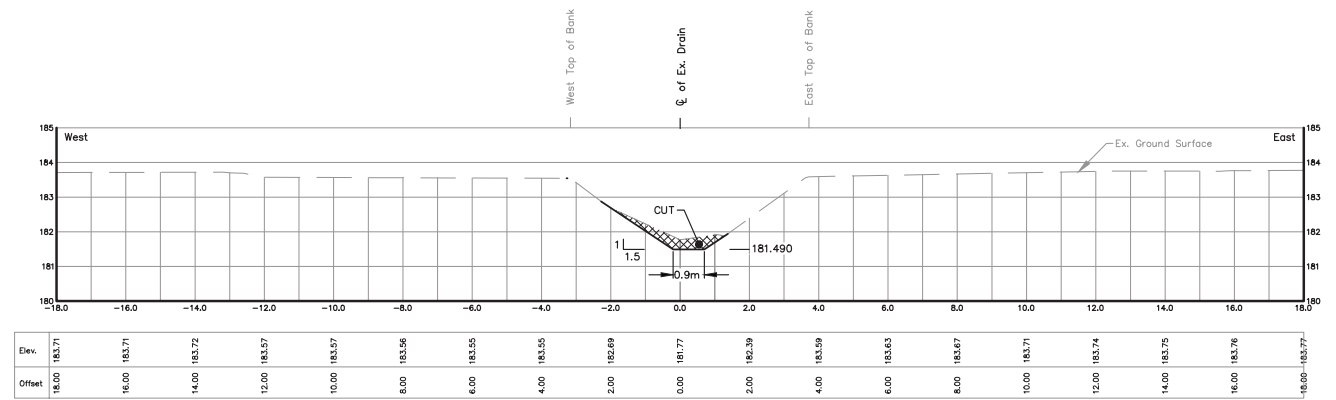

STA 7-8714
Scale = 1:100

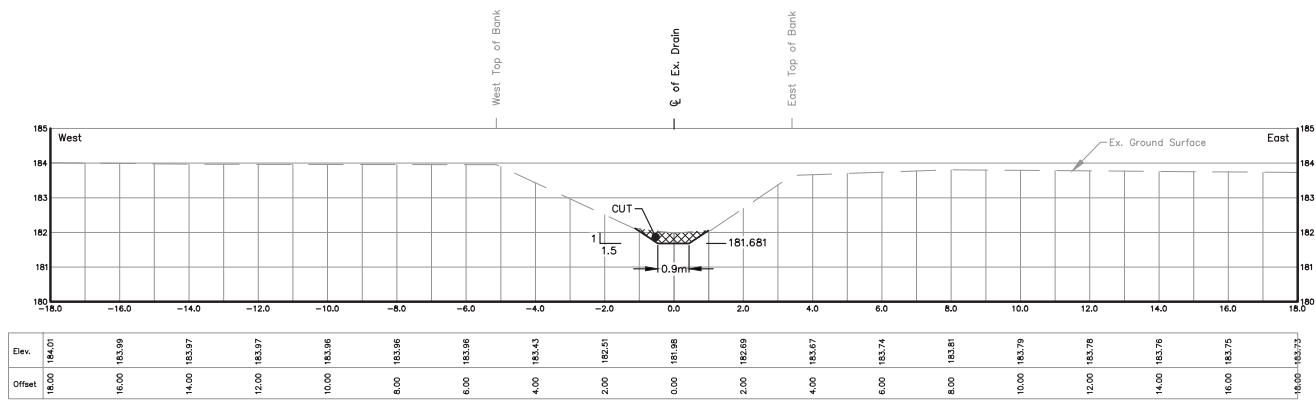

STA 7-7099
Scale = 1:100

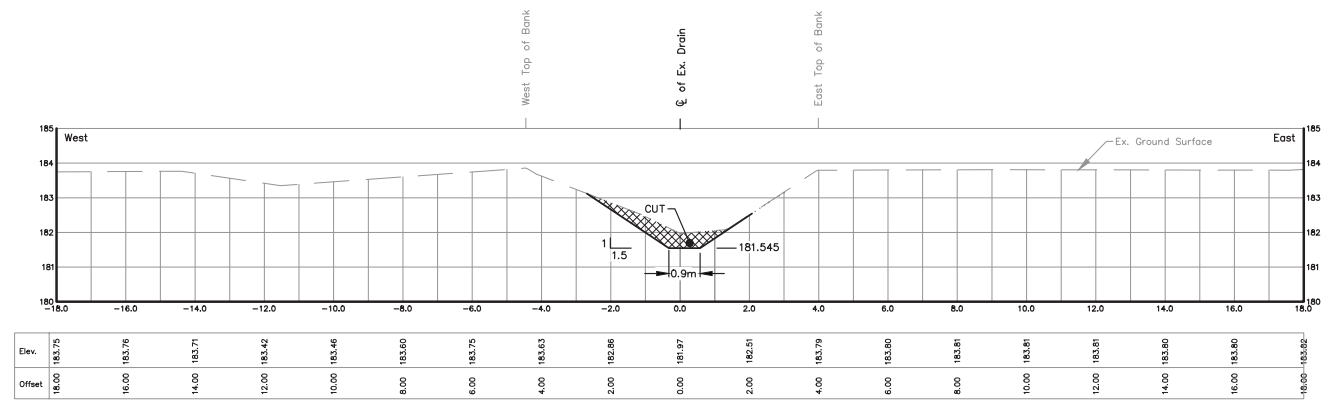

STA 7-8246
Scale = 1:100

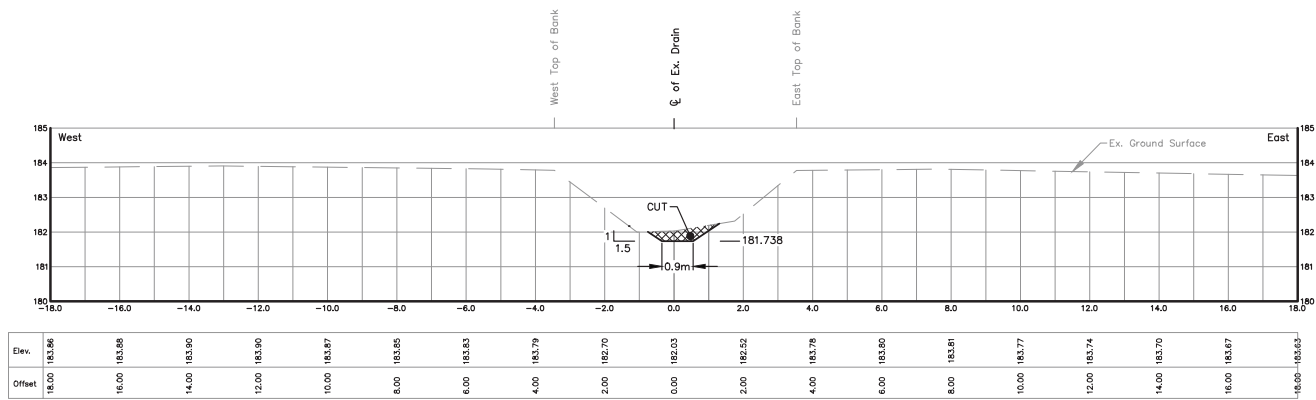

STA 7-6620
Scale = 1:100

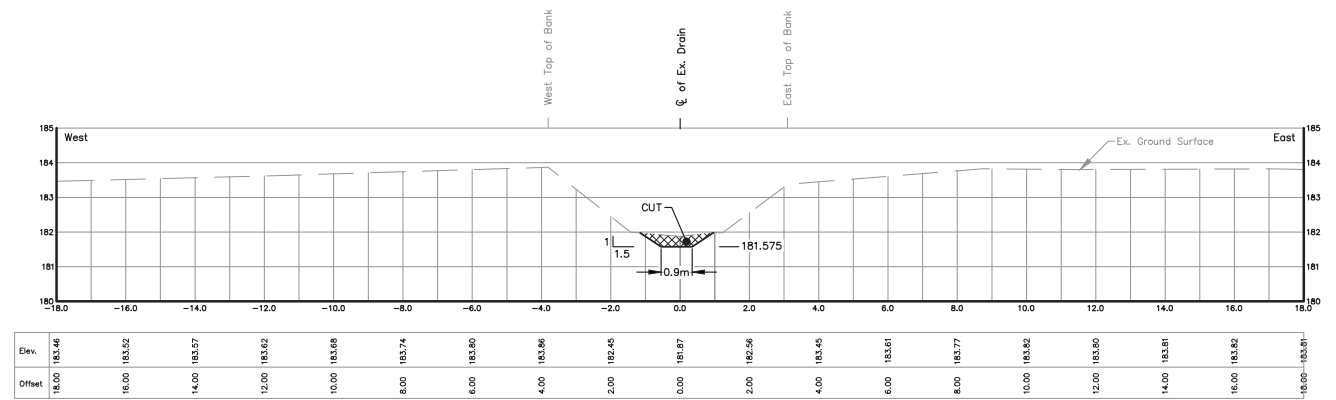

STA 7-7997
Scale = 1:100

THESE PLANS HAVE BEEN REDUCED
AND THE SCALE THEREFORE VARIES.
FULL SCALE PLANS MAY BE VIEWED
AT THE MUNICIPAL OFFICE.

DRAWN BY: G.S. & S.H.
PLOT CODE: 1:1
COMPUTER FILE: REI2015D010.DWG
FILE No.: **2015D010**
SHEET No.: **39 OF 51**

\\SERVER-2010\REI - Data - Server\PROJECTS\Projects 2015\REI-2015D010 - Sultan Creek Drain\Draw\REI2015D010 - Sections - Box 2022-02-28

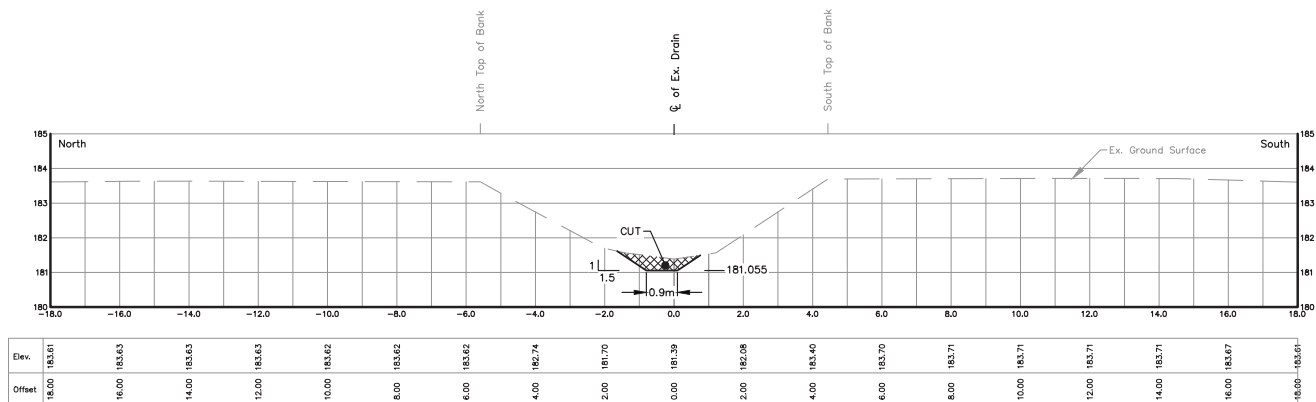

STA 8+238.2
Scale = 1:100

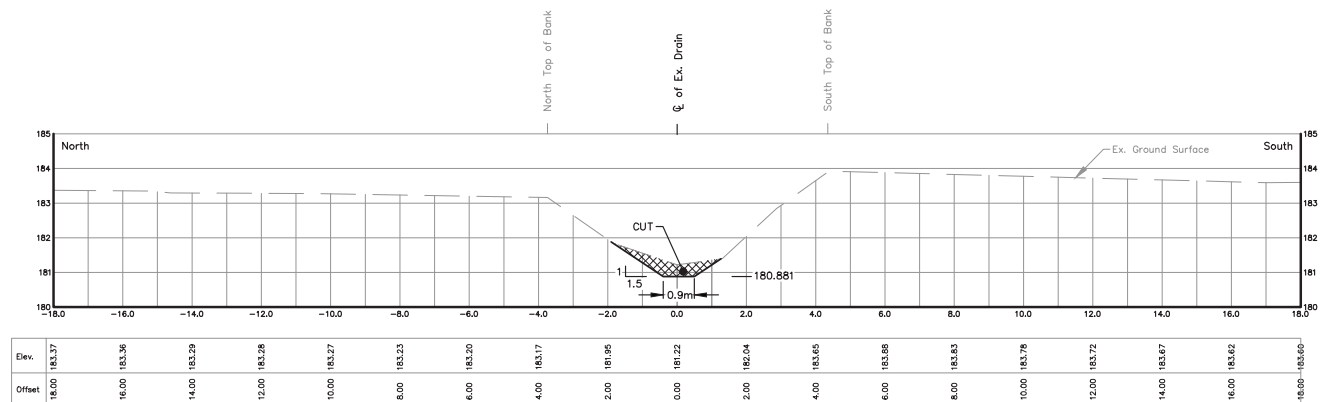

STA 8+385.0
Scale = 1:100

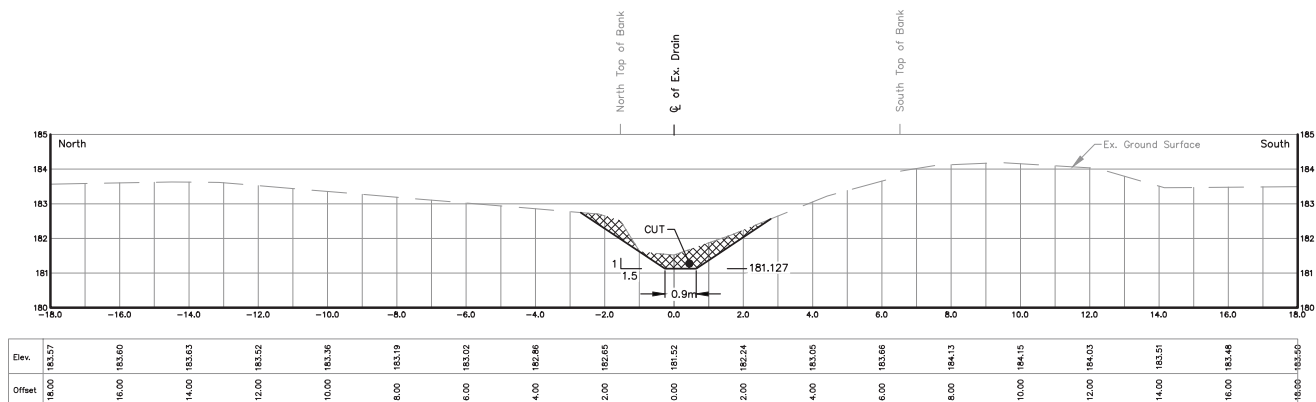

STA 8+177.7
Scale = 1:100

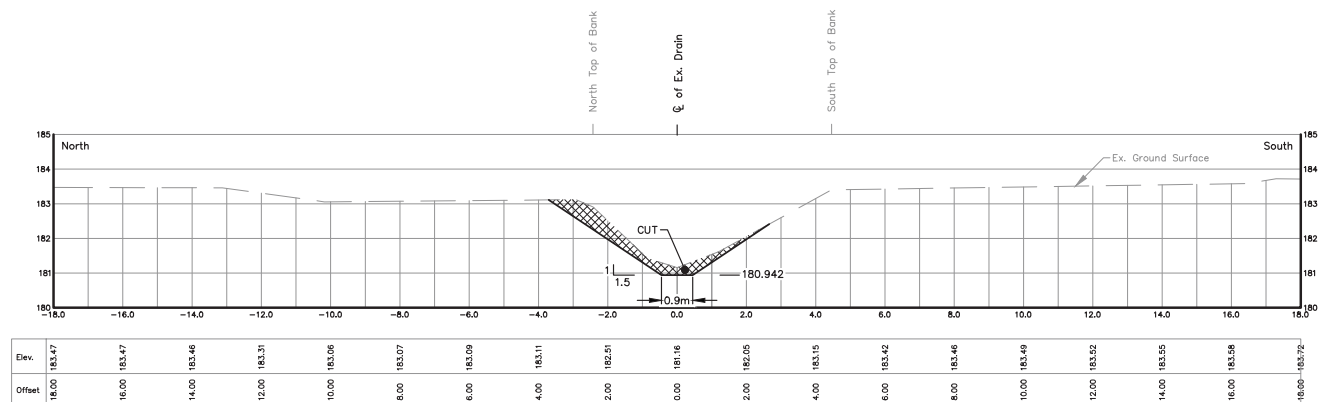

STA 8+333.7
Scale = 1:100

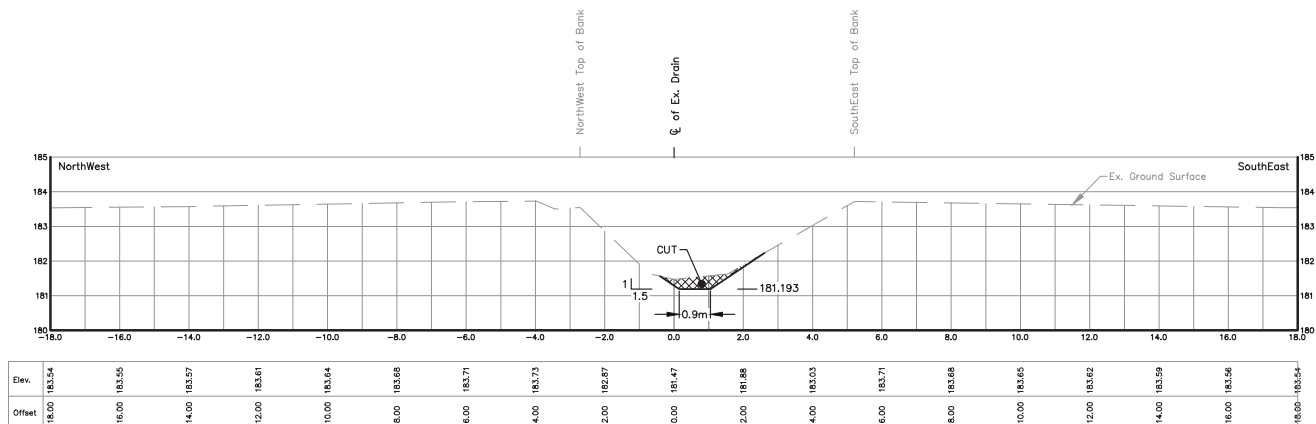

STA 8+122.1
Scale = 1:100

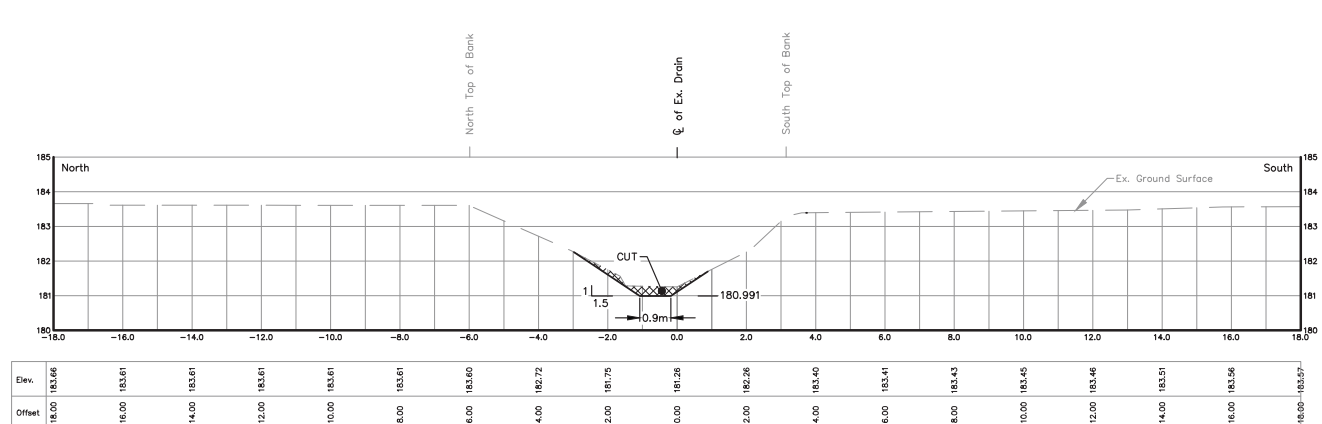

STA 8+292.3
Scale = 1:100

THESE PLANS HAVE BEEN REDUCED AND THE SCALE THEREFORE VARIES. FULL SCALE PLANS MAY BE VIEWED AT THE MUNICIPAL OFFICE.

DRAWN BY: G.S. & S.H.
PLOT CODE: 1:1
COMPUTER FILE: REI2015D010.DWG
FILE No.: **2015D010**
SHEET No.: **41 OF 51**

\\SERVER-2010\REI - Data Server\PROJECTS\PROJECTS\2015\REI-2015D010 - Sullivan Creek Drain\Draw\REI2015D010 - Sections B.dwg 2022-02-28

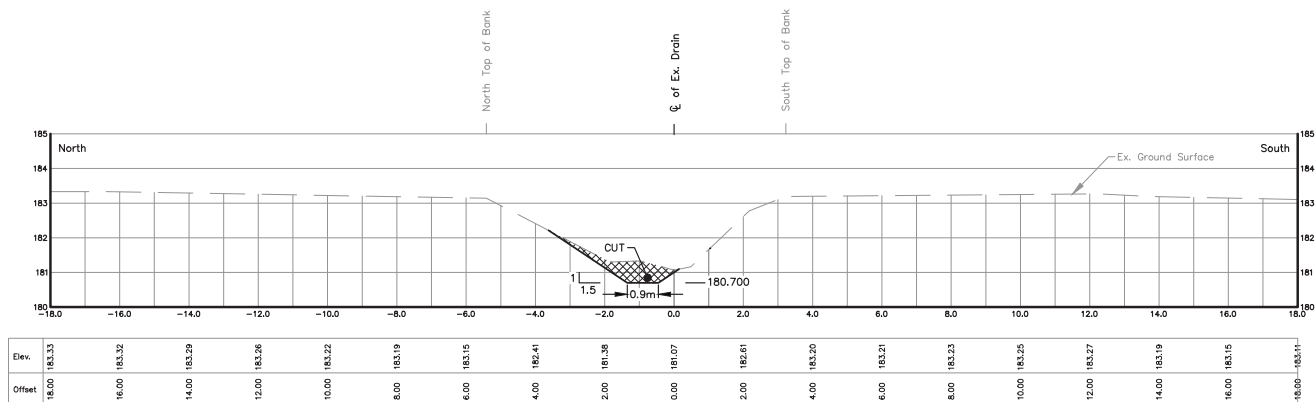

STA 8+537.7
Scale = 1:100

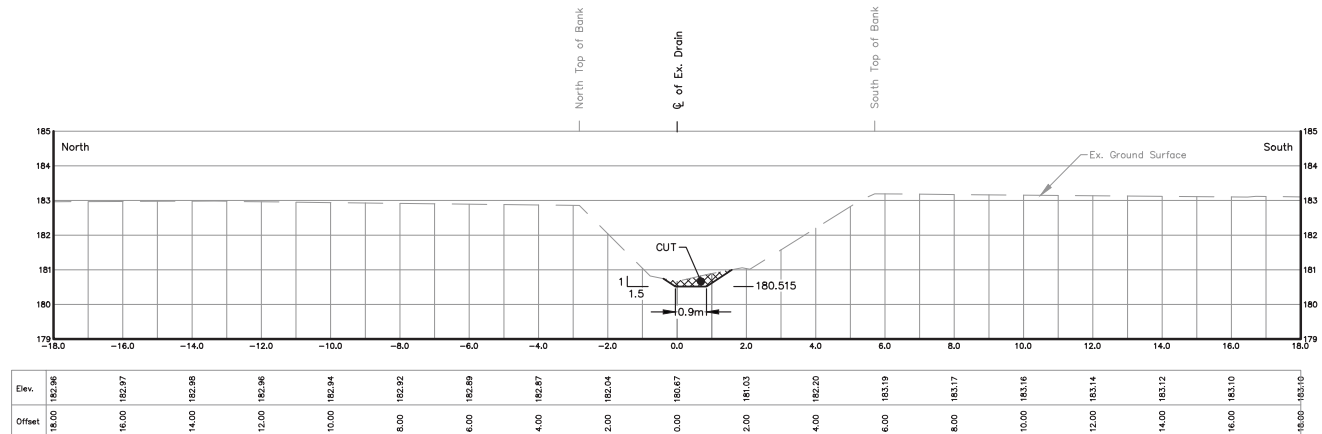

STA 8+694.6
Scale = 1:100

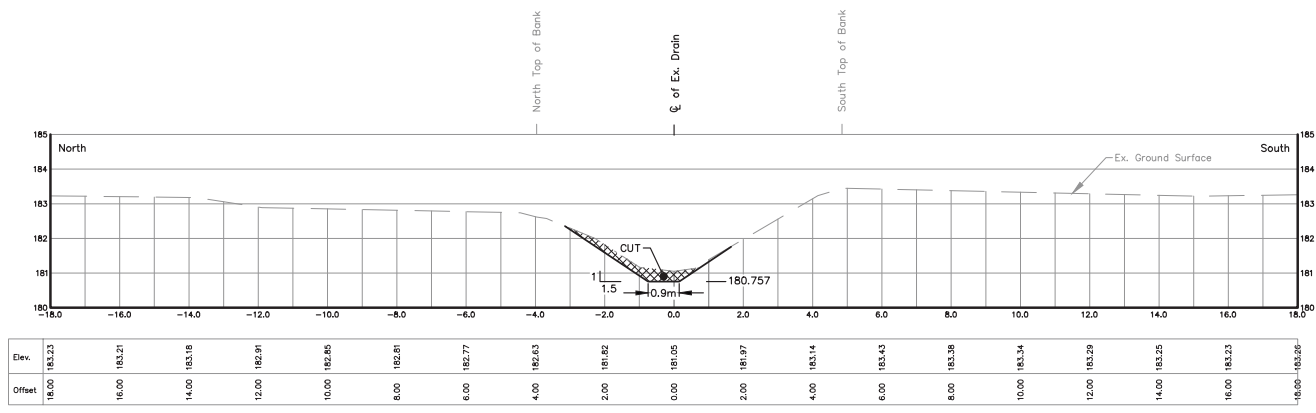

STA 8+490.0
Scale = 1:100

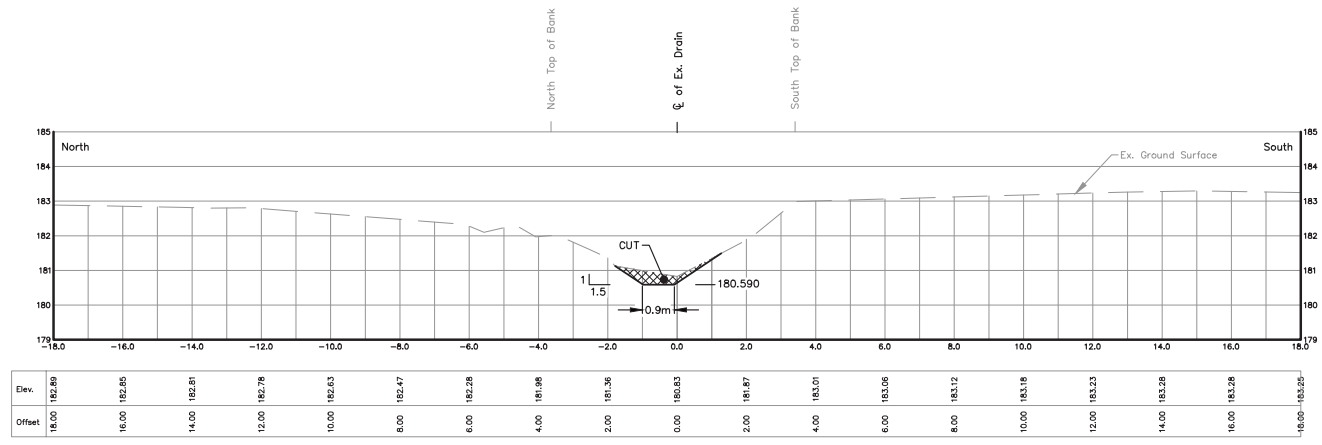

STA 8+631.0
Scale = 1:100

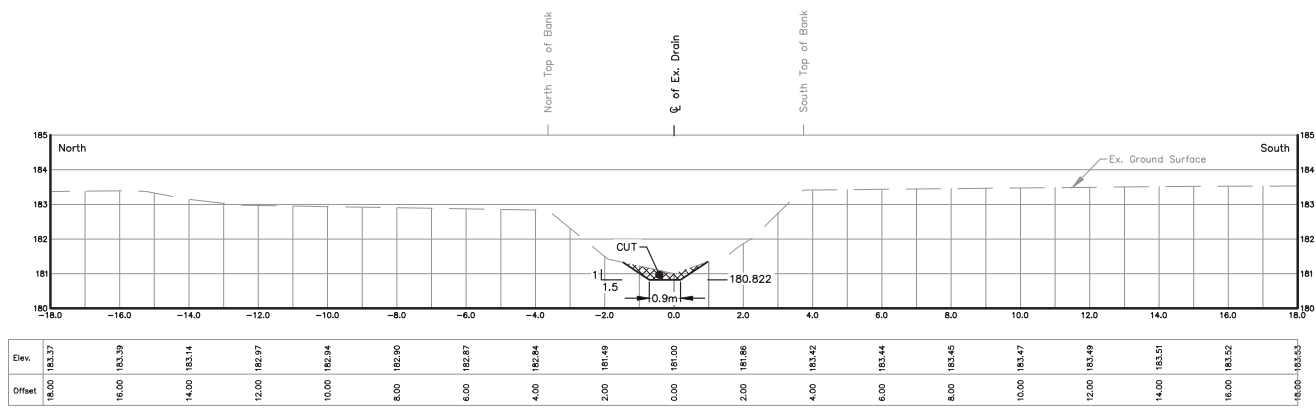

STA 8+434.8
Scale = 1:100

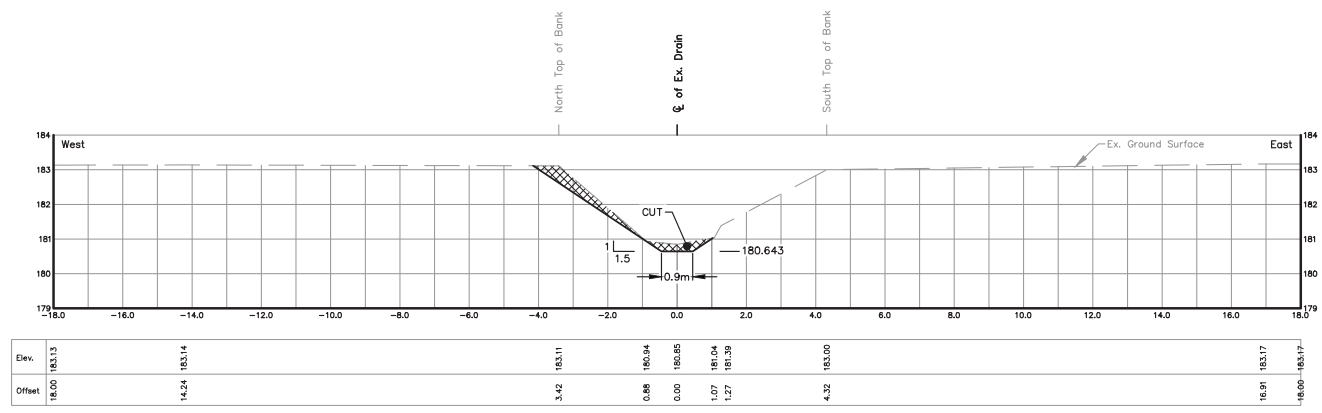

STA 8+586.3
Scale = 1:100

\\SERVER-2010\REI_Docs\Server\PROJECTS\Projects_2015\REI-20150010 - Sultan Creek Drain\Draw\REI20150010 - Sections B.dwg 2022-02-28

23

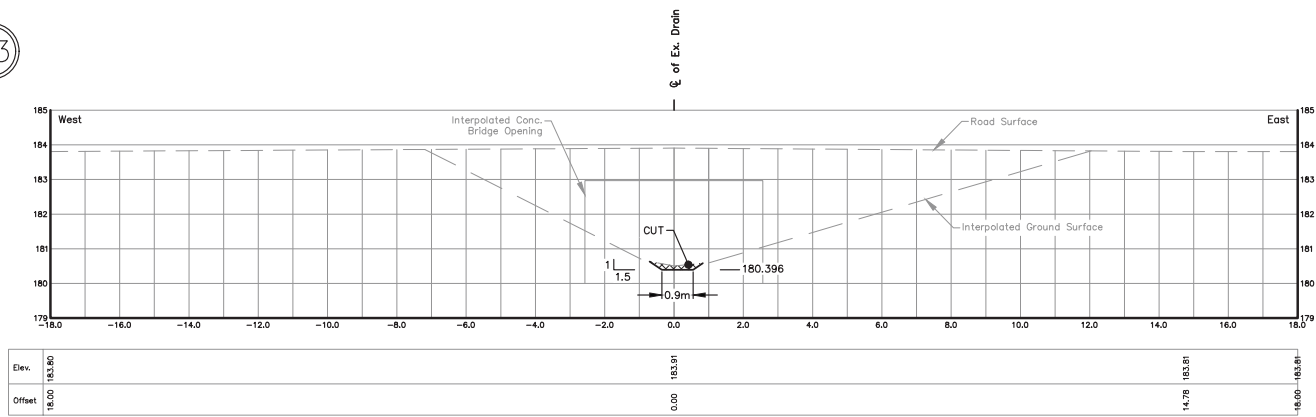

STA 8+794.7
Scale = 1:100

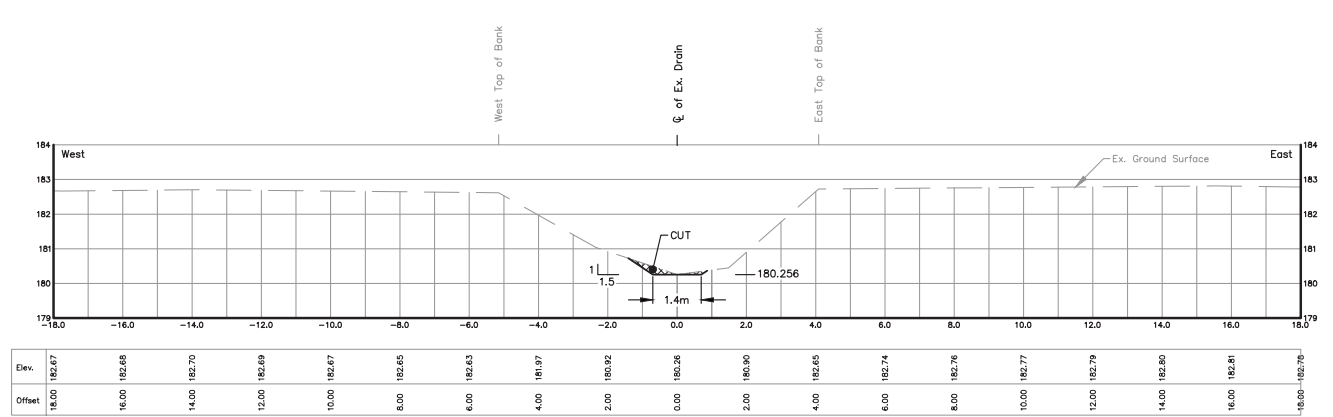

STA 8+913.3
Scale = 1:100

23

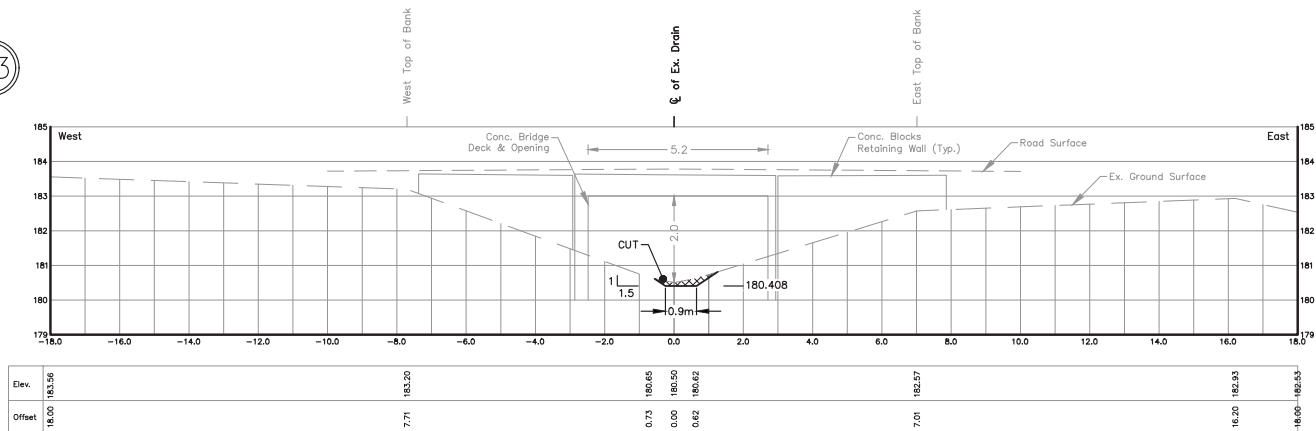

STA 8+784.8
Scale = 1:100

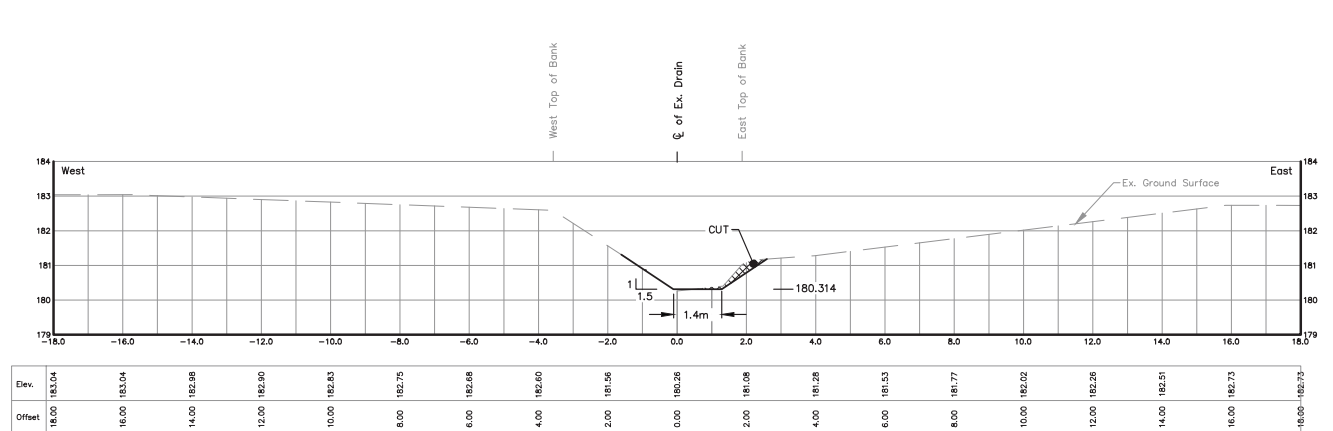

STA 8+864.3
Scale = 1:100

23

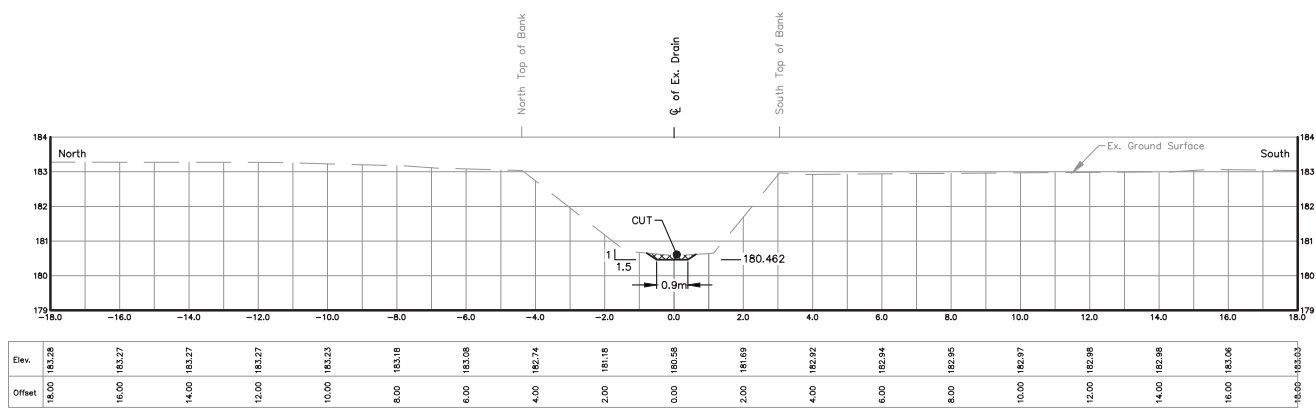

STA 8+739.5
Scale = 1:100

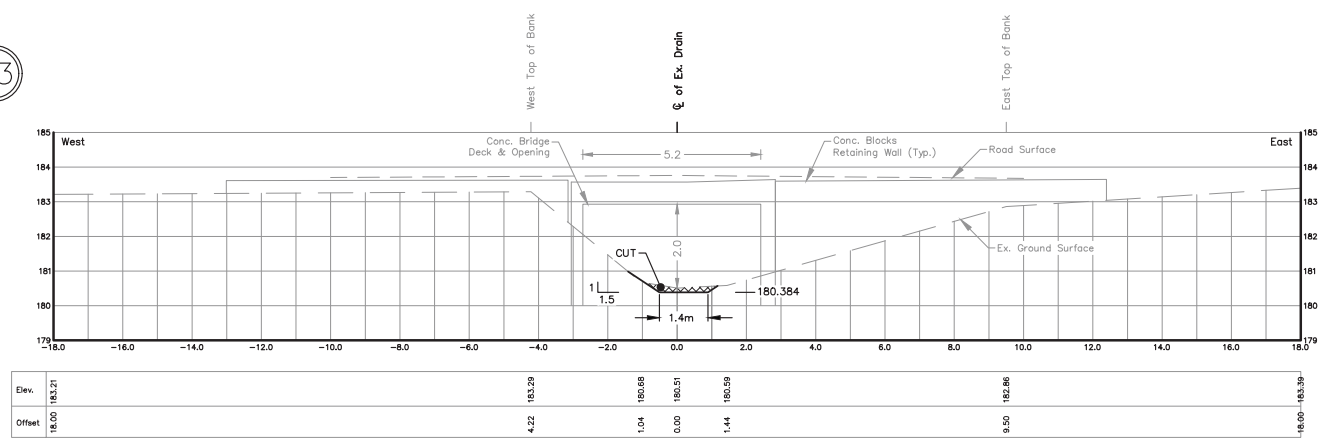

STA 8+804.8
Scale = 1:100

THESE PLANS HAVE BEEN REDUCED AND THE SCALE THEREFORE VARIES. FULL SCALE PLANS MAY BE VIEWED AT THE MUNICIPAL OFFICE.

DRAWN BY: G.S. & S.H.
PLOT CODE: 1:1
COMPUTER FILE: REI2015D010.DWG
FILE No.: 2015D010 SHEET No.: 43 OF 51

SERVER:2015\REI Data Server\PROJECTS\PROJECTS\2015\REI-2015D010 - Sullivan Creek Drain\Draw\REI2015D010 - Sections B.dwg 2022-02-28

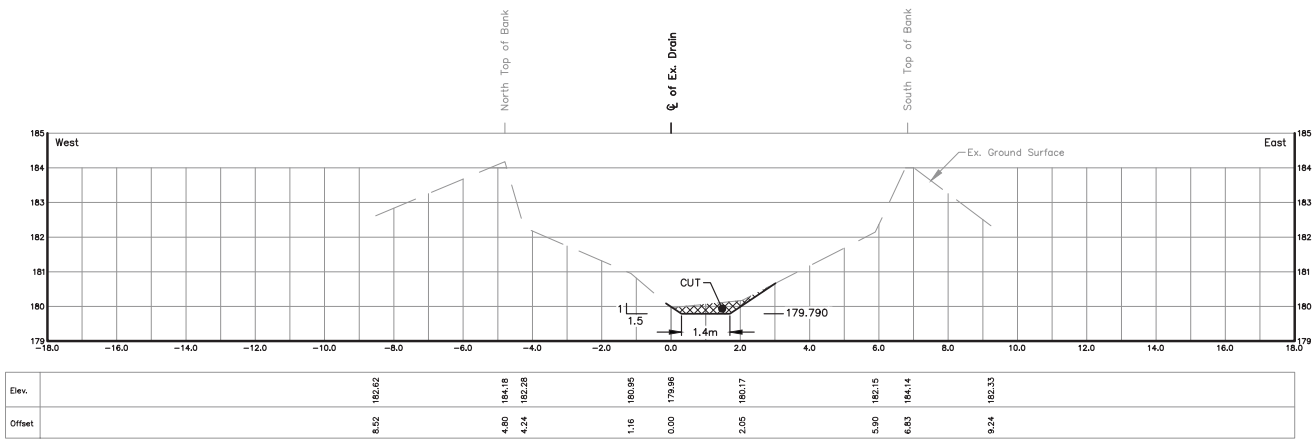

STA 9+306.3
Scale = 1:100

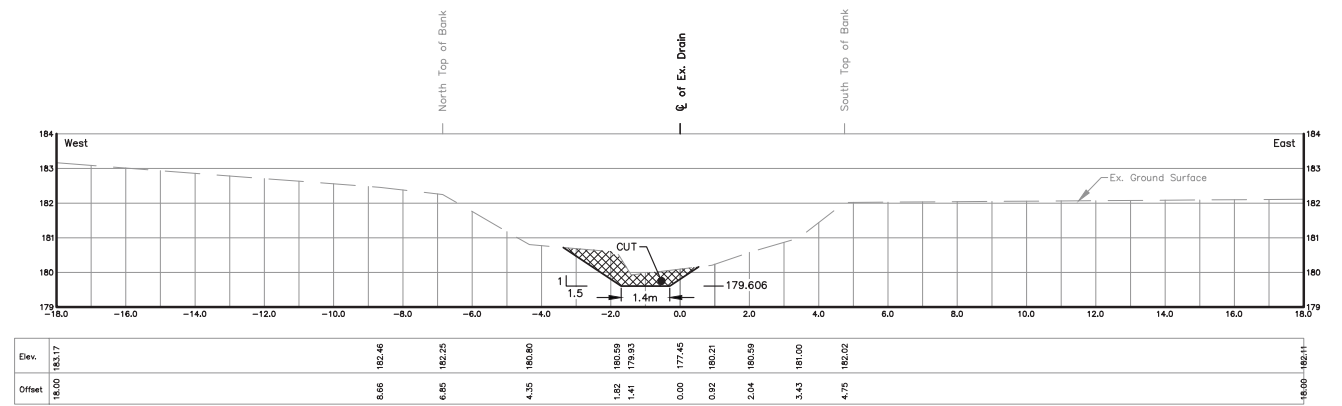

STA 9+462.2
Scale = 1:100

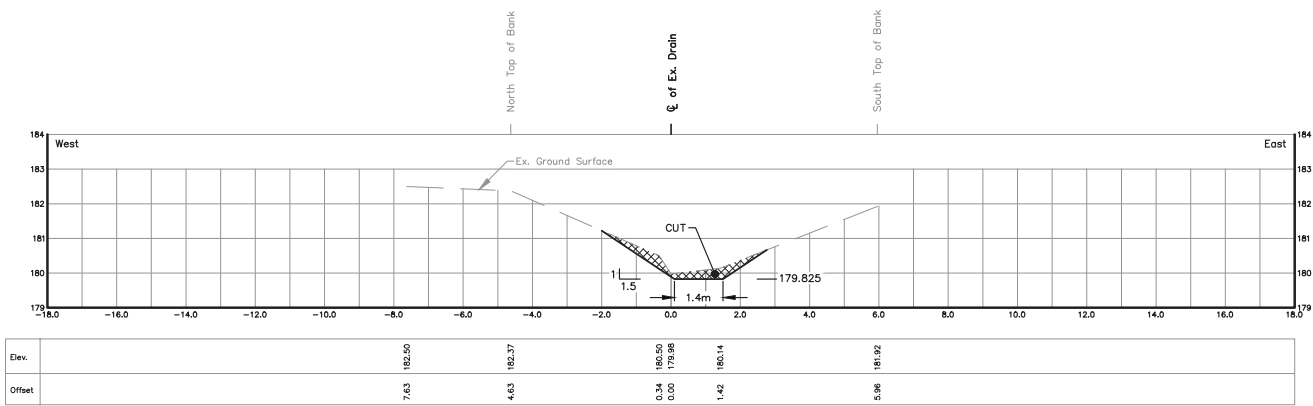

STA 9+277.0
Scale = 1:100

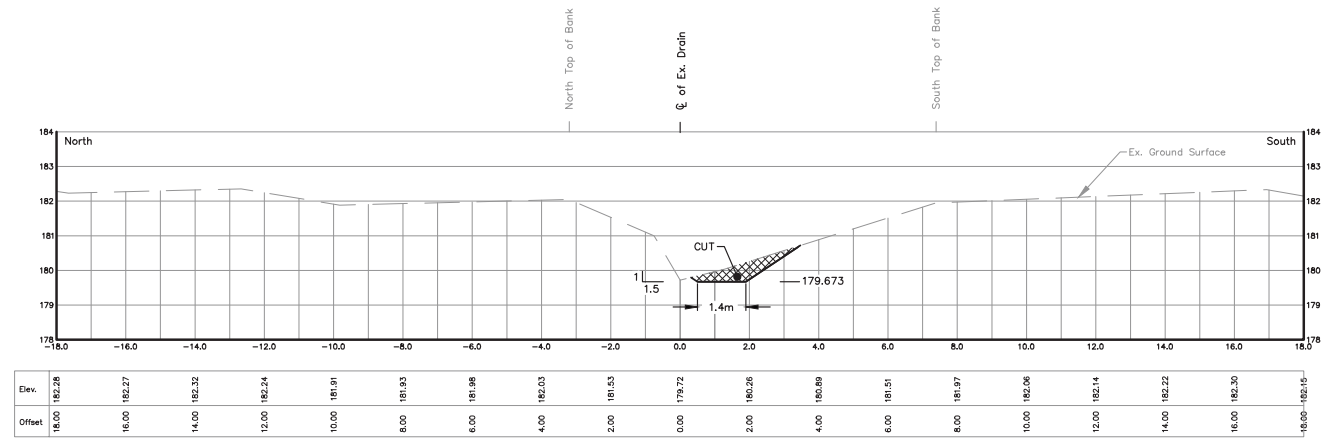

STA 9+401.8
Scale = 1:100

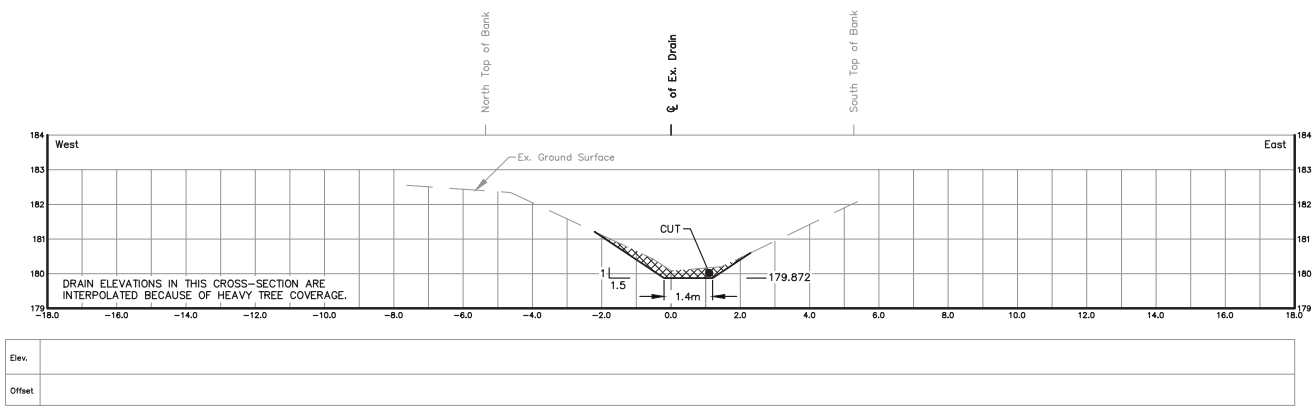

STA 9+237.0
Scale = 1:100

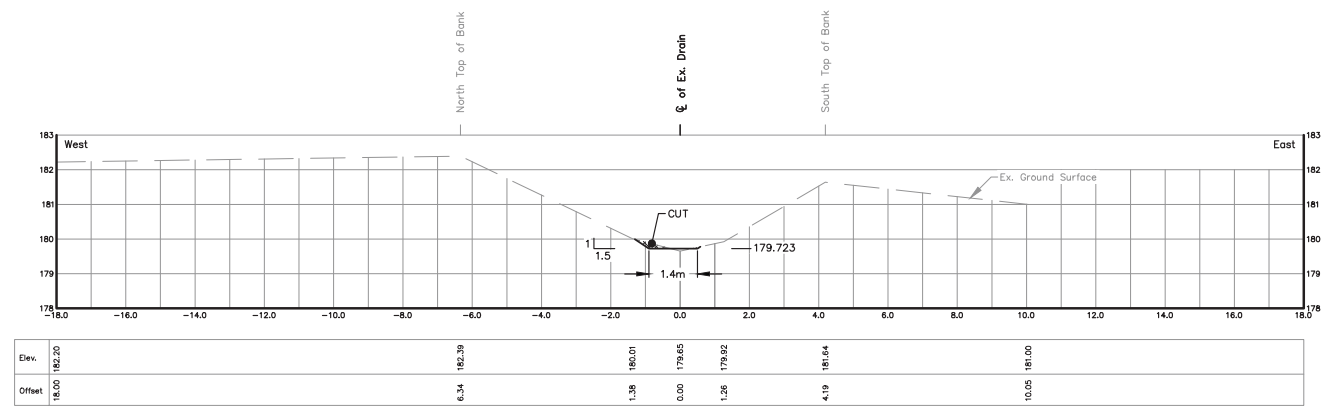

STA 9+362.8
Scale = 1:100

THESE PLANS HAVE BEEN REDUCED AND THE SCALE THEREFORE VARIES FULL SCALE PLANS MAY BE VIEWED AT THE MUNICIPAL OFFICE.

SERVER: 2015\REI Data Server\DRAGTING\PROJECTS\Projects 2015\REI-2015D010 - Sullivan Creek Drain\Map\REI2015D010 - Sections B.dwg 2022-02-28

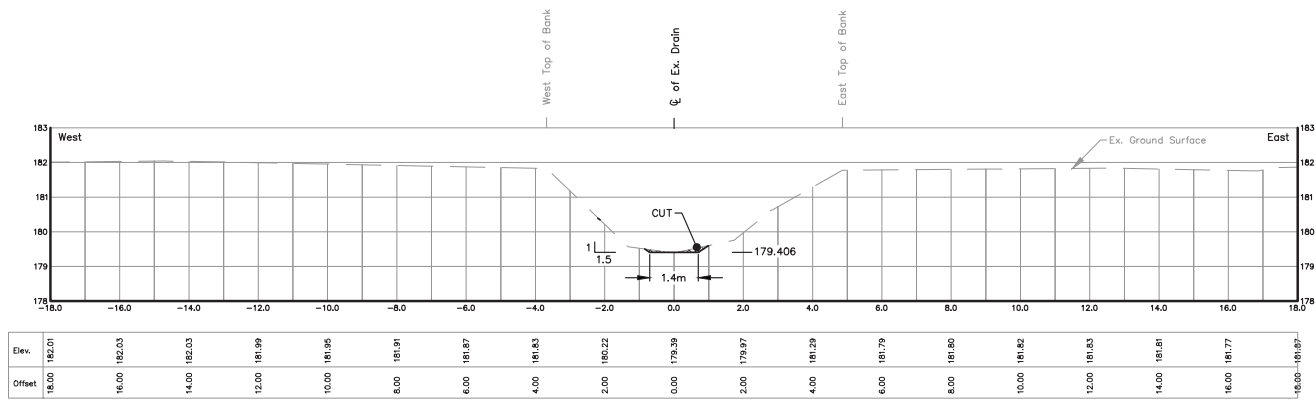

STA 9+522.0
Scale = 1:100

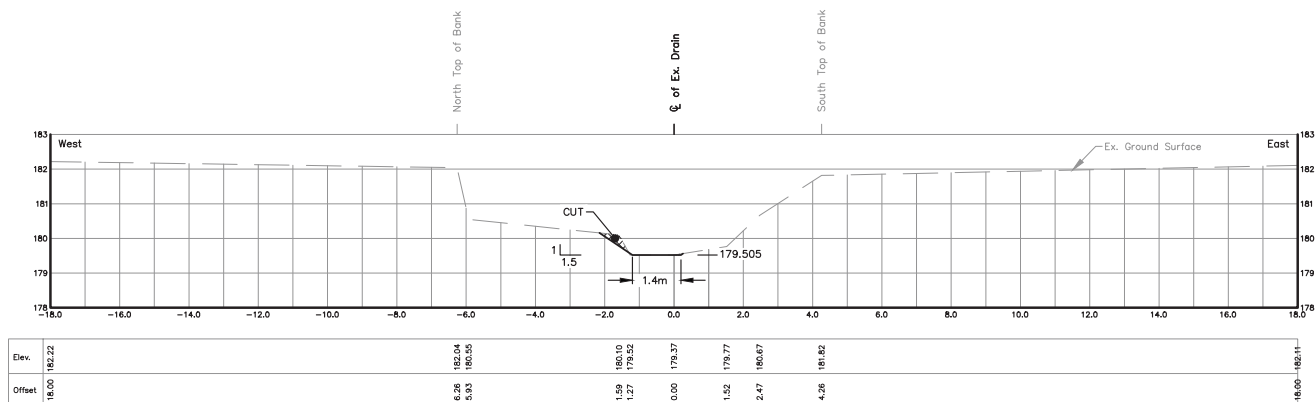

STA 9+524.5
Scale = 1:100

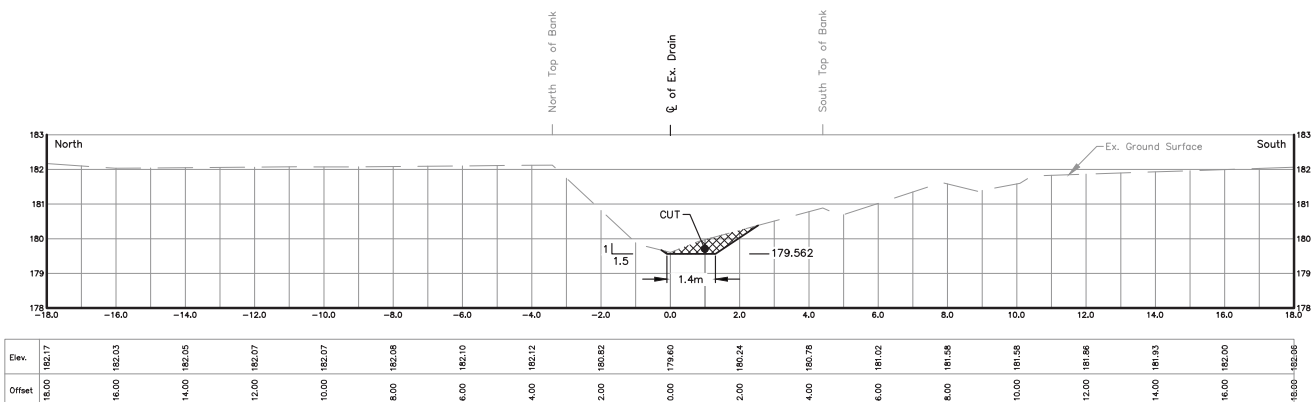

STA 9+499.1
Scale = 1:100

24

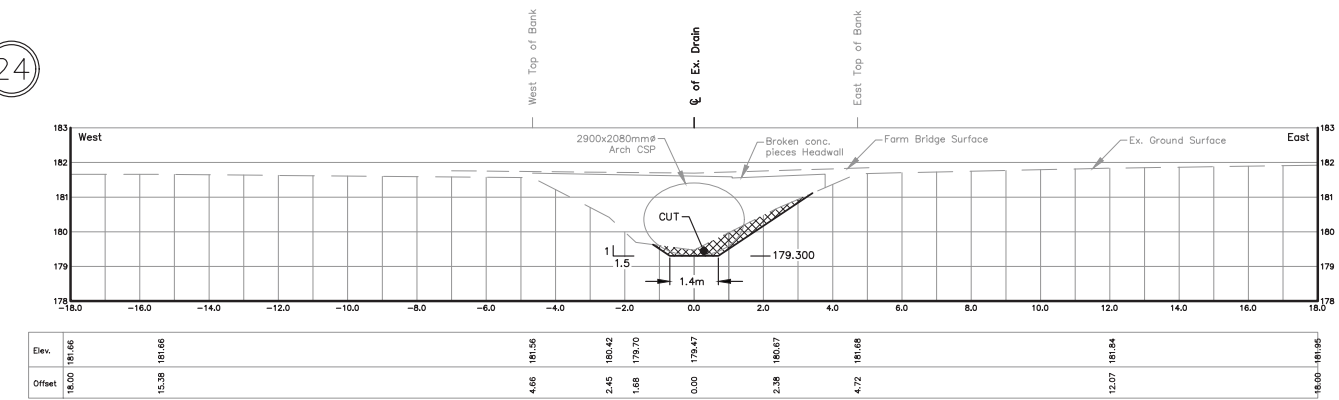

STA 9+608.8
Scale = 1:100

24

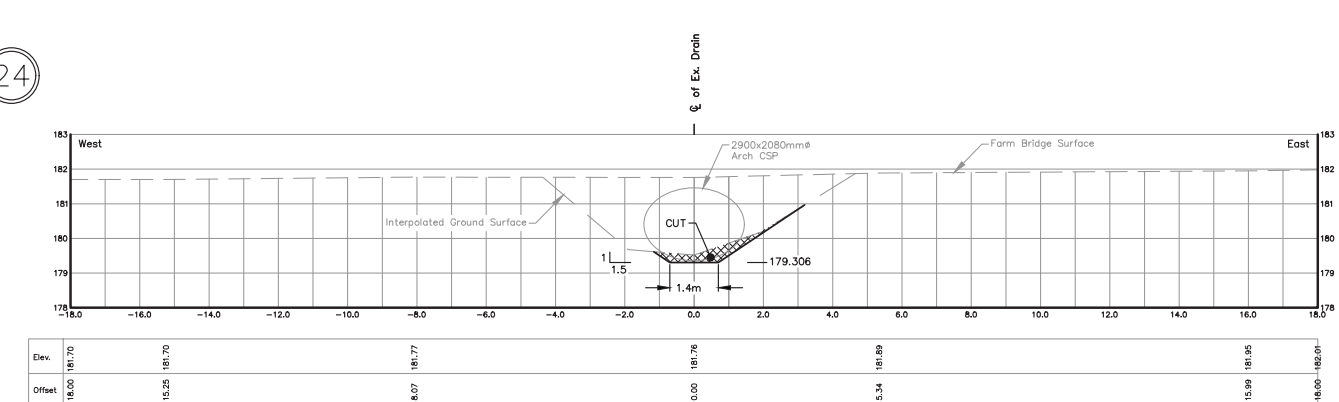

STA 9+606.1
Scale = 1:100

24

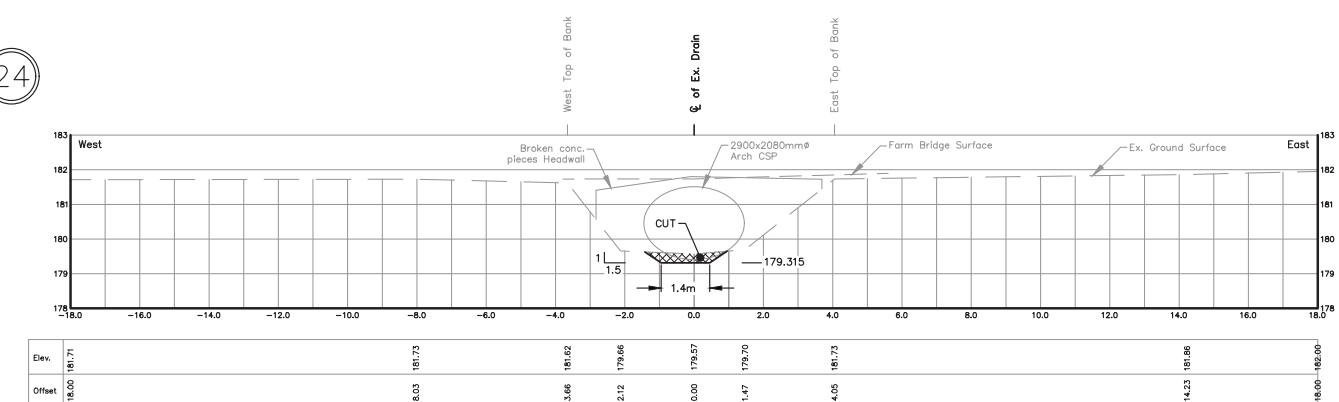

STA 9+602.5
Scale = 1:100

THESE PLANS HAVE BEEN REDUCED AND THE SCALE THEREFORE VARIES. FULL SCALE PLANS MAY BE VIEWED AT THE MUNICIPAL OFFICE.

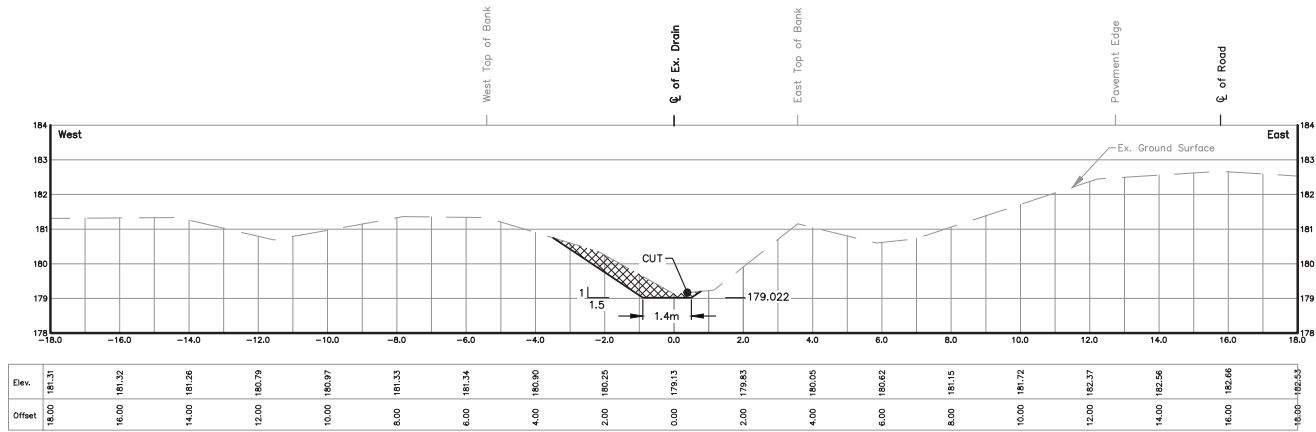

STA 9+722.5
Scale = 1:100

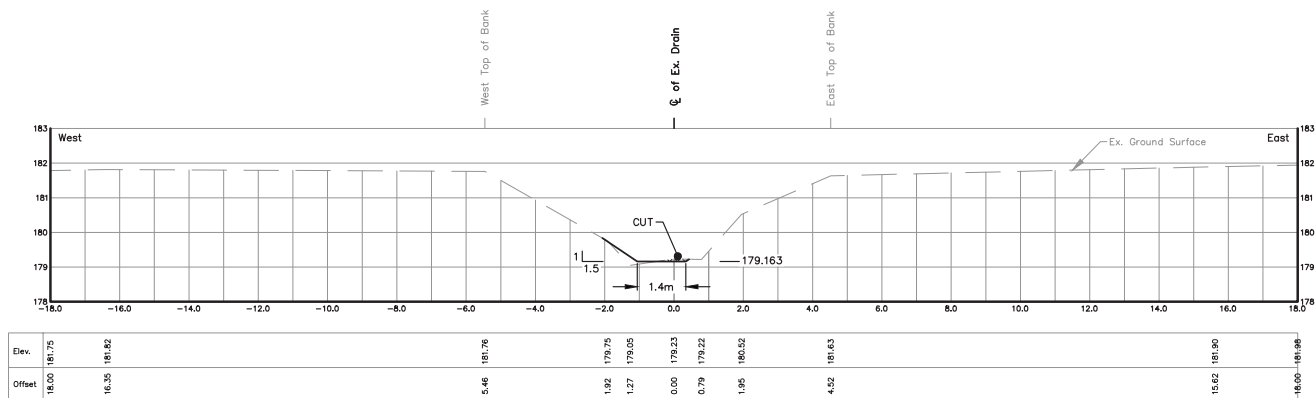

STA 9+664.7
Scale = 1:100

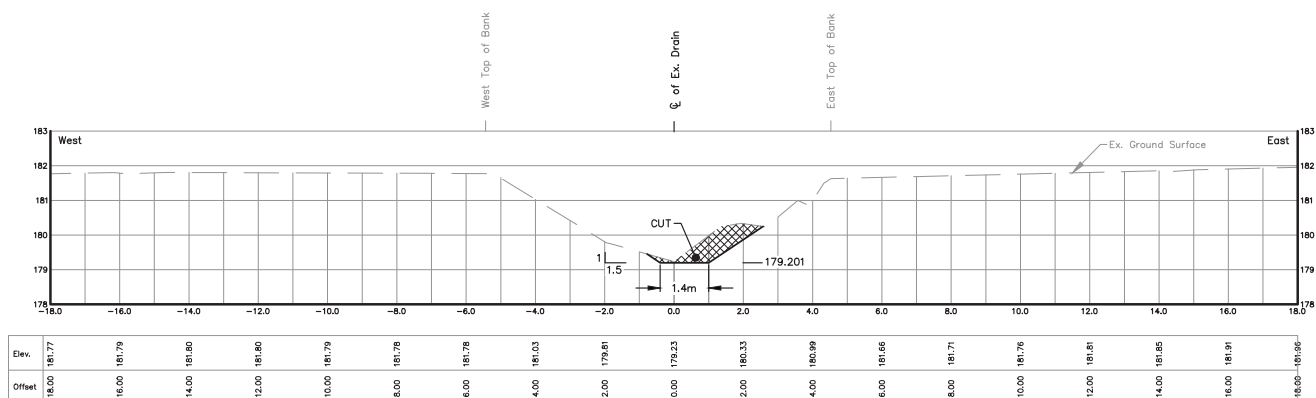

STA 9+649.3
Scale = 1:100

25

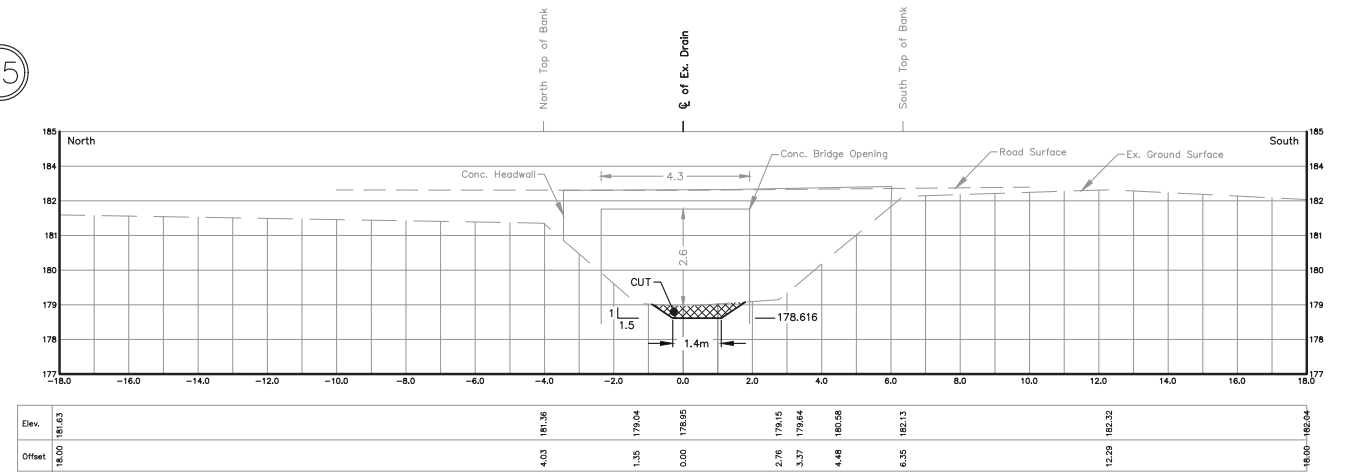

STA 9+833.5
Scale = 1:100

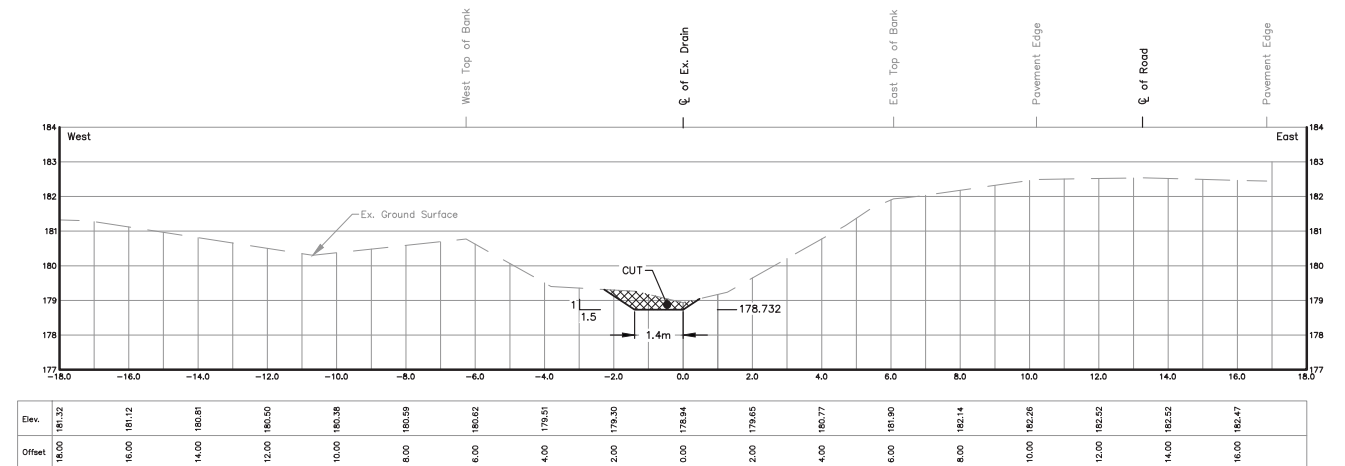

STA 9+804.6
Scale = 1:100

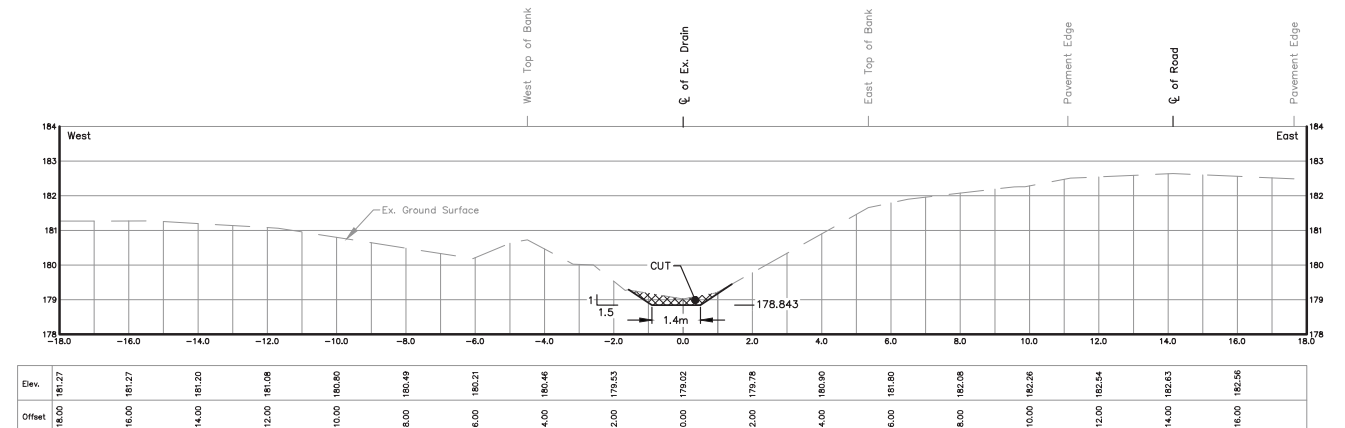

STA 9+773.6
Scale = 1:100

THESE PLANS HAVE BEEN REDUCED
AND THE SCALE THEREFORE VARIES.
FULL SCALE PLANS MAY BE VIEWED
AT THE MUNICIPAL OFFICE.

DRAWN BY: G.S. & S.H.
PLOT CODE: 1:1
COMPUTER FILE: REI2015D010.DWG
FILE No.: 2015D010 SHEET No.: 47 OF 51

SERVER:2015\REI Data Server\DRAGAGE\PROJECTS\Projects 2015\REI-2015D010 - Sullom Creek Drain\Map\REI2015D010 - Sections B.dwg 2022-02-28

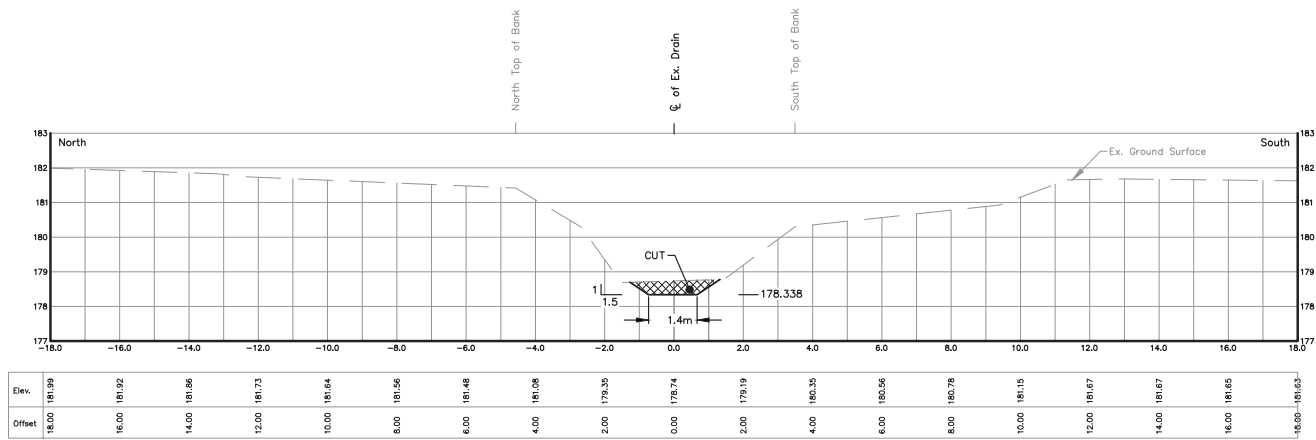

STA 9+899.4
Scale = 1:100

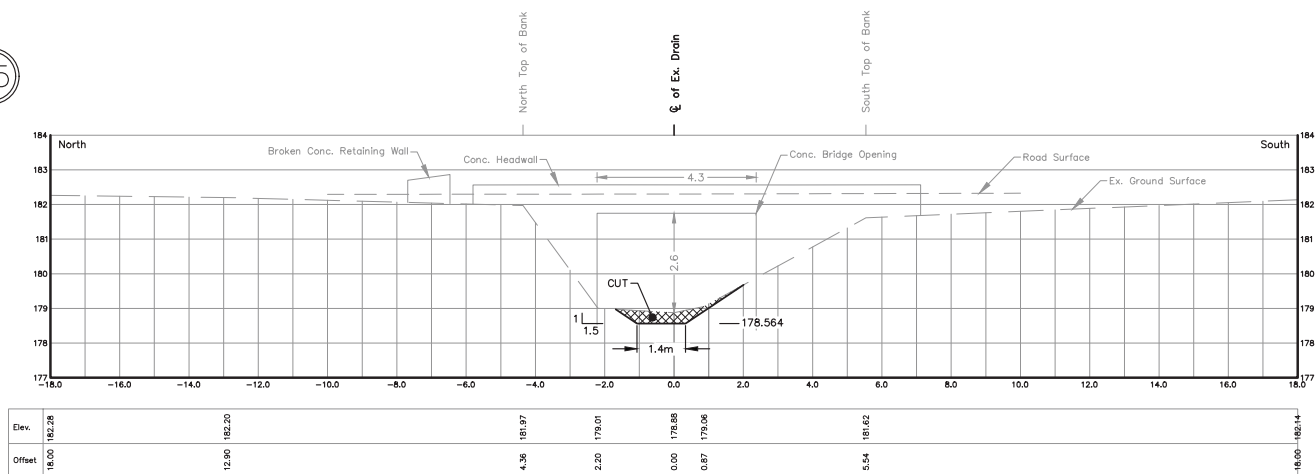

STA 9+846.4
Scale = 1:100

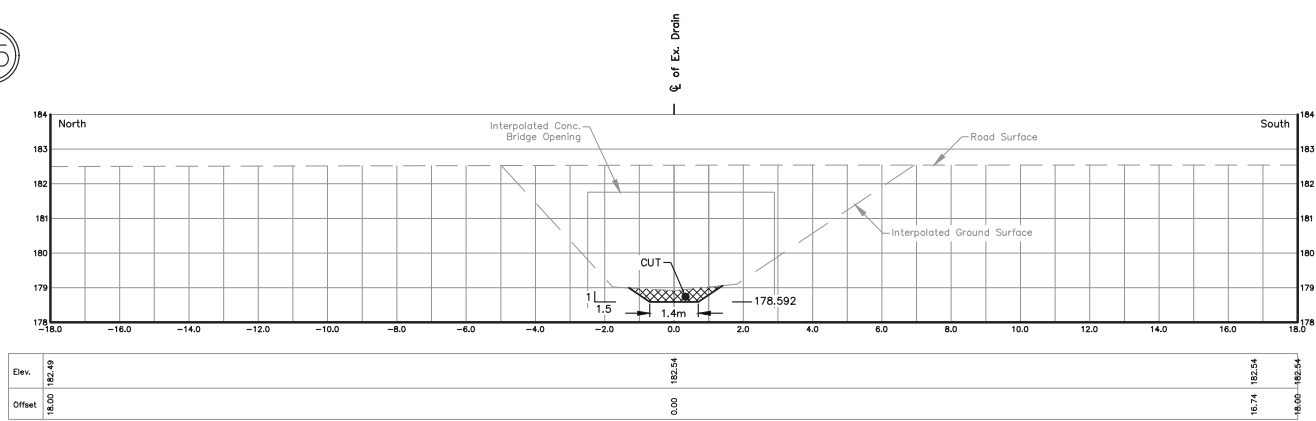

STA 9+839.5
Scale = 1:100

END OF SULLIVAN CREEK DRAIN

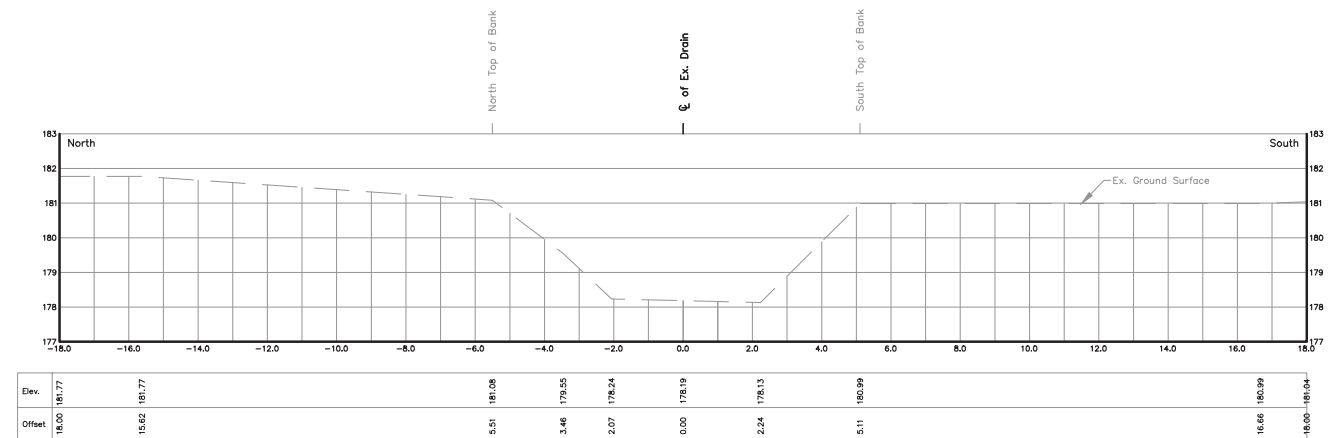

STA 9+962.9
Scale = 1:100

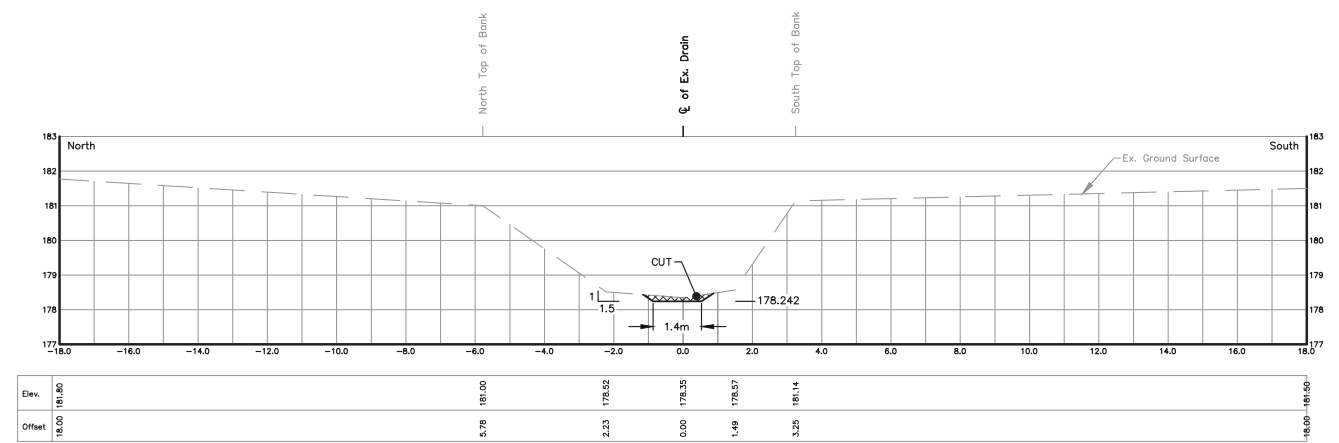

STA 9+926.7
Scale = 1:100

THESE PLANS HAVE BEEN REDUCED AND THE SCALE THEREFORE VARIES. FULL SCALE PLANS MAY BE VIEWED AT THE MUNICIPAL OFFICE.

DRAWN BY: G.S. & S.H.
PLOT CODE: 1:1
COMPUTER FILE: REI2015D010.DWG
FILE No.: 2015D010
SHEET No.: 48 OF 51

SERVER:2015\REI Data Server\PROJECTS\PROJECTS\2015\REI-2015D010 - Sullivan Creek Drain\Drawings\2015D010 - Sections - Boxes - 02-28

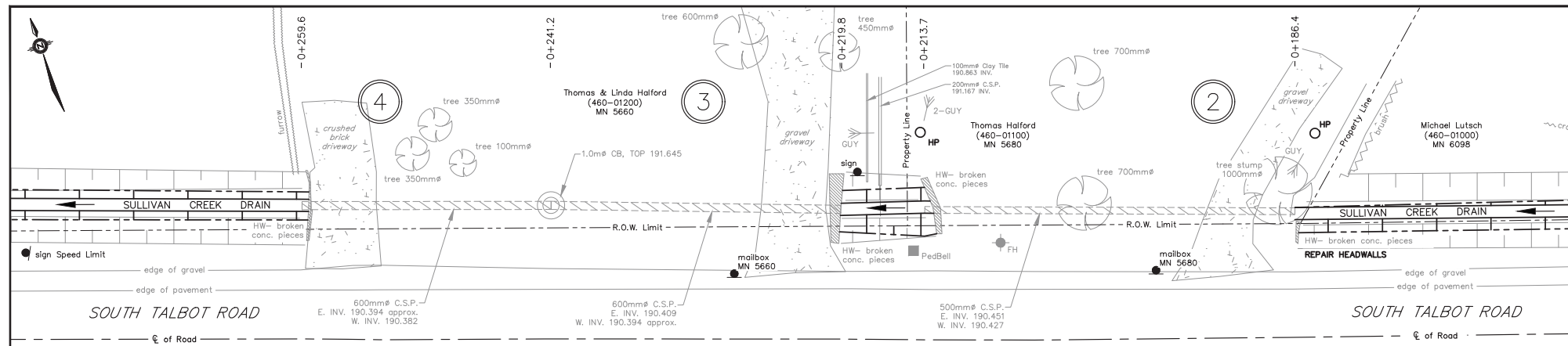

BENCHMARK		FOR FUTURE MAINTENANCE		BENCHMARK		FOR FUTURE MAINTENANCE		BENCHMARK		FOR FUTURE MAINTENANCE	
TOP MIDDLE OF SOUTH HEADWALL OF CONCRETE BRIDGE AT SOUTH TALBOT ROAD & WEST BRANCH OF DELSLE DRAIN.		TOP MIDDLE OF SOUTH HEADWALL OF CONCRETE BRIDGE AT SOUTH TALBOT ROAD & WEST BRANCH OF DELSLE DRAIN.		TOP MIDDLE OF SOUTH HEADWALL OF CONCRETE BRIDGE AT SOUTH TALBOT ROAD & WEST BRANCH OF DELSLE DRAIN.		TOP MIDDLE OF SOUTH HEADWALL OF CONCRETE BRIDGE AT SOUTH TALBOT ROAD & WEST BRANCH OF DELSLE DRAIN.		TOP MIDDLE OF SOUTH HEADWALL OF CONCRETE BRIDGE AT SOUTH TALBOT ROAD & WEST BRANCH OF DELSLE DRAIN.		TOP MIDDLE OF SOUTH HEADWALL OF CONCRETE BRIDGE AT SOUTH TALBOT ROAD & WEST BRANCH OF DELSLE DRAIN.	
ELEV. 191.812m		ELEV. 191.812m		ELEV. 191.812m		ELEV. 191.812m		ELEV. 191.812m		ELEV. 191.812m	
PIPE SIZE	PIPE LENGTH	CORRUG. SIZE	CORRUGATIONS	MATERIAL/TYPE	PIPE INVERT ELEVATIONS	PIPE SIZE	PIPE LENGTH	CORRUG. SIZE	CORRUGATIONS	MATERIAL/TYPE	PIPE INVERT ELEVATIONS
600mm	18.3m (60.2ft)	68mm x 13mm	STANDARD	CSP	UPSTREAM INV. (E)=190.394m approx. DOWNSTREAM INV. (W)=190.382m % OF DRIVEWAY=191.804m DESIGN DRAIN GRADE=+0.06%	600mm	21.3m (70.0ft)	68mm x 13mm	STANDARD	CSP	UPSTREAM INV. (E)=190.409m DOWNSTREAM INV. (W)=190.394m approx. % OF DRIVEWAY=191.837m DESIGN DRAIN GRADE=+0.06%
500mm	27.3m (89.6ft)	68mm x 13mm	STANDARD	CSP	UPSTREAM INV. (E)=190.451m DOWNSTREAM INV. (W)=190.427m % OF DRIVEWAY=191.837m DESIGN DRAIN GRADE=+0.06%	500mm	27.3m (89.6ft)	68mm x 13mm	STANDARD	CSP	UPSTREAM INV. (E)=190.451m DOWNSTREAM INV. (W)=190.427m % OF DRIVEWAY=191.837m DESIGN DRAIN GRADE=+0.06%

BRIDGE #4 PLAN

SCALE=1:200

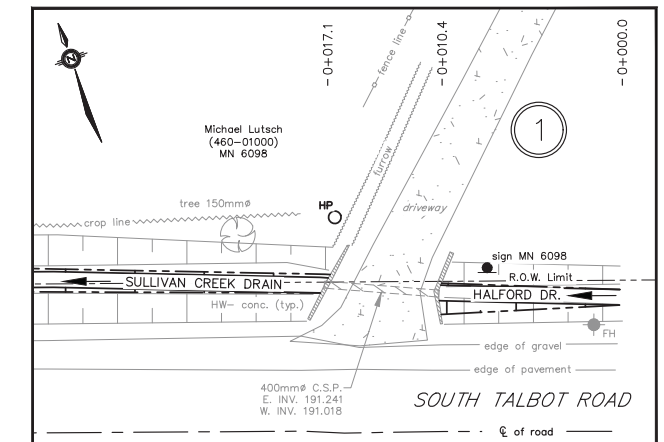

BENCHMARK		FOR FUTURE MAINTENANCE		BENCHMARK		FOR FUTURE MAINTENANCE					
TOP MIDDLE OF SOUTH HEADWALL OF CONCRETE BRIDGE AT SOUTH TALBOT ROAD & WEST BRANCH OF DELSLE DRAIN.		TOP MIDDLE OF SOUTH HEADWALL OF CONCRETE BRIDGE AT SOUTH TALBOT ROAD & WEST BRANCH OF DELSLE DRAIN.		TOP MIDDLE OF SOUTH HEADWALL OF CONCRETE BRIDGE AT SOUTH TALBOT ROAD & WEST BRANCH OF DELSLE DRAIN.		TOP MIDDLE OF SOUTH HEADWALL OF CONCRETE BRIDGE AT SOUTH TALBOT ROAD & WEST BRANCH OF DELSLE DRAIN.					
ELEV. 191.812m		ELEV. 191.812m		ELEV. 191.812m		ELEV. 191.812m					
PIPE SIZE	PIPE LENGTH	CORRUG. SIZE	CORRUGATIONS	MATERIAL/TYPE	PIPE INVERT ELEVATIONS	PIPE SIZE	PIPE LENGTH	CORRUG. SIZE	CORRUGATIONS	MATERIAL/TYPE	PIPE INVERT ELEVATIONS
400mm	6.7m (22.0ft)	68mm x 13mm	STANDARD	CSP	UPSTREAM INV. (E)=191.241m DOWNSTREAM INV. (W)=191.018m % OF DRIVEWAY=192.12m DESIGN DRAIN GRADE=+2.23%	400mm	6.7m (22.0ft)	68mm x 13mm	STANDARD	CSP	UPSTREAM INV. (E)=191.241m DOWNSTREAM INV. (W)=191.018m % OF DRIVEWAY=192.12m DESIGN DRAIN GRADE=+2.23%

BRIDGE #1 PLAN

SCALE=1:200

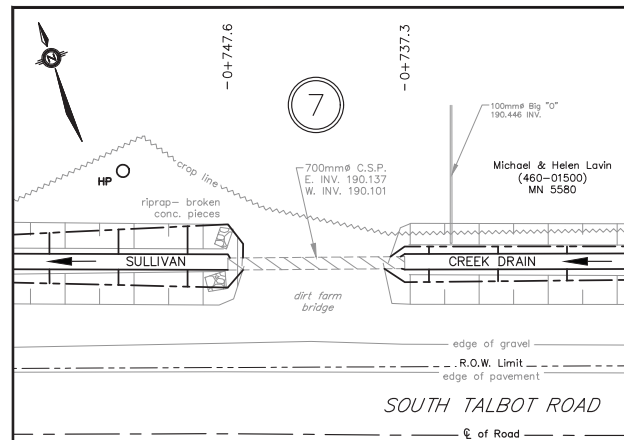

BENCHMARK		FOR FUTURE MAINTENANCE		BENCHMARK		FOR FUTURE MAINTENANCE					
TOP MIDDLE OF SOUTH HEADWALL OF CONCRETE BRIDGE AT SOUTH TALBOT ROAD & WEST BRANCH OF DELSLE DRAIN.		TOP MIDDLE OF SOUTH HEADWALL OF CONCRETE BRIDGE AT SOUTH TALBOT ROAD & WEST BRANCH OF DELSLE DRAIN.		TOP MIDDLE OF SOUTH HEADWALL OF CONCRETE BRIDGE AT SOUTH TALBOT ROAD & WEST BRANCH OF DELSLE DRAIN.		TOP MIDDLE OF SOUTH HEADWALL OF CONCRETE BRIDGE AT SOUTH TALBOT ROAD & WEST BRANCH OF DELSLE DRAIN.					
ELEV. 191.812m		ELEV. 191.812m		ELEV. 191.812m		ELEV. 191.812m					
PIPE SIZE	PIPE LENGTH	CORRUG. SIZE	CORRUGATIONS	MATERIAL/TYPE	PIPE INVERT ELEVATIONS	PIPE SIZE	PIPE LENGTH	CORRUG. SIZE	CORRUGATIONS	MATERIAL/TYPE	PIPE INVERT ELEVATIONS
700mm	10.3m (33.8ft)	68mm x 13mm	STANDARD	CSP	UPSTREAM INV. (E)=190.137m DOWNSTREAM INV. (W)=190.101m % OF FARM BRIDGE=191.528m UPS. DESIGN GRADE=+0.06% DOWNS. DESIGN GRADE=+0.10%	700mm	6.3m (20.7ft)	68mm x 13mm	STANDARD	CSP	UPSTREAM INV. (E)=190.264m DOWNSTREAM INV. (W)=190.237m % OF DRIVEWAY=191.464m DESIGN DRAIN GRADE=+0.10%

BRIDGE #7 PLAN

SCALE=1:200

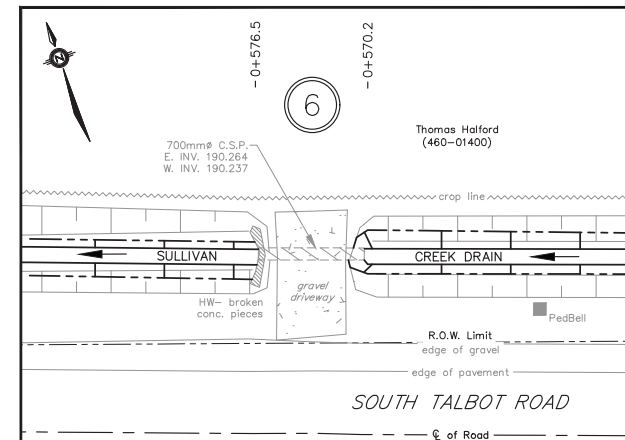

BENCHMARK		FOR FUTURE MAINTENANCE		BENCHMARK		FOR FUTURE MAINTENANCE					
TOP MIDDLE OF SOUTH HEADWALL OF CONCRETE BRIDGE AT SOUTH TALBOT ROAD & WEST BRANCH OF DELSLE DRAIN.		TOP MIDDLE OF SOUTH HEADWALL OF CONCRETE BRIDGE AT SOUTH TALBOT ROAD & WEST BRANCH OF DELSLE DRAIN.		TOP MIDDLE OF SOUTH HEADWALL OF CONCRETE BRIDGE AT SOUTH TALBOT ROAD & WEST BRANCH OF DELSLE DRAIN.		TOP MIDDLE OF SOUTH HEADWALL OF CONCRETE BRIDGE AT SOUTH TALBOT ROAD & WEST BRANCH OF DELSLE DRAIN.					
ELEV. 191.812m		ELEV. 191.812m		ELEV. 191.812m		ELEV. 191.812m					
PIPE SIZE	PIPE LENGTH	CORRUG. SIZE	CORRUGATIONS	MATERIAL/TYPE	PIPE INVERT ELEVATIONS	PIPE SIZE	PIPE LENGTH	CORRUG. SIZE	CORRUGATIONS	MATERIAL/TYPE	PIPE INVERT ELEVATIONS
700mm	6.3m (20.7ft)	68mm x 13mm	STANDARD	CSP	UPSTREAM INV. (E)=190.264m DOWNSTREAM INV. (W)=190.237m % OF DRIVEWAY=191.464m DESIGN DRAIN GRADE=+0.10%	700mm	6.3m (20.7ft)	68mm x 13mm	STANDARD	CSP	UPSTREAM INV. (E)=190.264m DOWNSTREAM INV. (W)=190.237m % OF DRIVEWAY=191.464m DESIGN DRAIN GRADE=+0.10%

BRIDGE #6 PLAN

SCALE=1:200

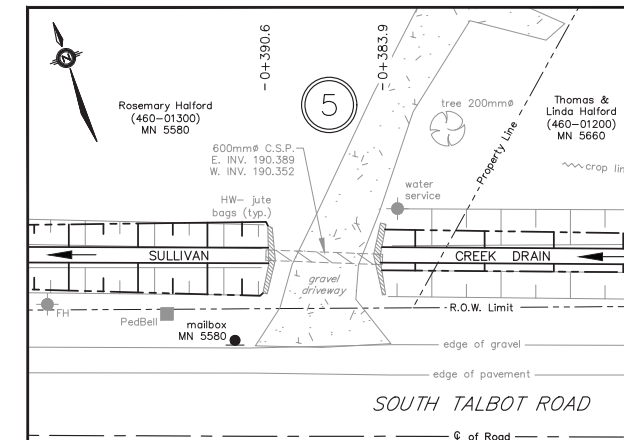

BENCHMARK		FOR FUTURE MAINTENANCE		BENCHMARK		FOR FUTURE MAINTENANCE					
TOP MIDDLE OF SOUTH HEADWALL OF CONCRETE BRIDGE AT SOUTH TALBOT ROAD & WEST BRANCH OF DELSLE DRAIN.		TOP MIDDLE OF SOUTH HEADWALL OF CONCRETE BRIDGE AT SOUTH TALBOT ROAD & WEST BRANCH OF DELSLE DRAIN.		TOP MIDDLE OF SOUTH HEADWALL OF CONCRETE BRIDGE AT SOUTH TALBOT ROAD & WEST BRANCH OF DELSLE DRAIN.		TOP MIDDLE OF SOUTH HEADWALL OF CONCRETE BRIDGE AT SOUTH TALBOT ROAD & WEST BRANCH OF DELSLE DRAIN.					
ELEV. 191.812m		ELEV. 191.812m		ELEV. 191.812m		ELEV. 191.812m					
PIPE SIZE	PIPE LENGTH	CORRUG. SIZE	CORRUGATIONS	MATERIAL/TYPE	PIPE INVERT ELEVATIONS	PIPE SIZE	PIPE LENGTH	CORRUG. SIZE	CORRUGATIONS	MATERIAL/TYPE	PIPE INVERT ELEVATIONS
600mm	6.7m (22.0ft)	68mm x 13mm	STANDARD	CSP	UPSTREAM INV. (E)=190.389m DOWNSTREAM INV. (W)=190.352m % OF DRIVEWAY=191.760m DESIGN DRAIN GRADE=+0.10%	600mm	6.7m (22.0ft)	68mm x 13mm	STANDARD	CSP	UPSTREAM INV. (E)=190.389m DOWNSTREAM INV. (W)=190.352m % OF DRIVEWAY=191.760m DESIGN DRAIN GRADE=+0.10%

BRIDGE #5 PLAN

SCALE=1:200

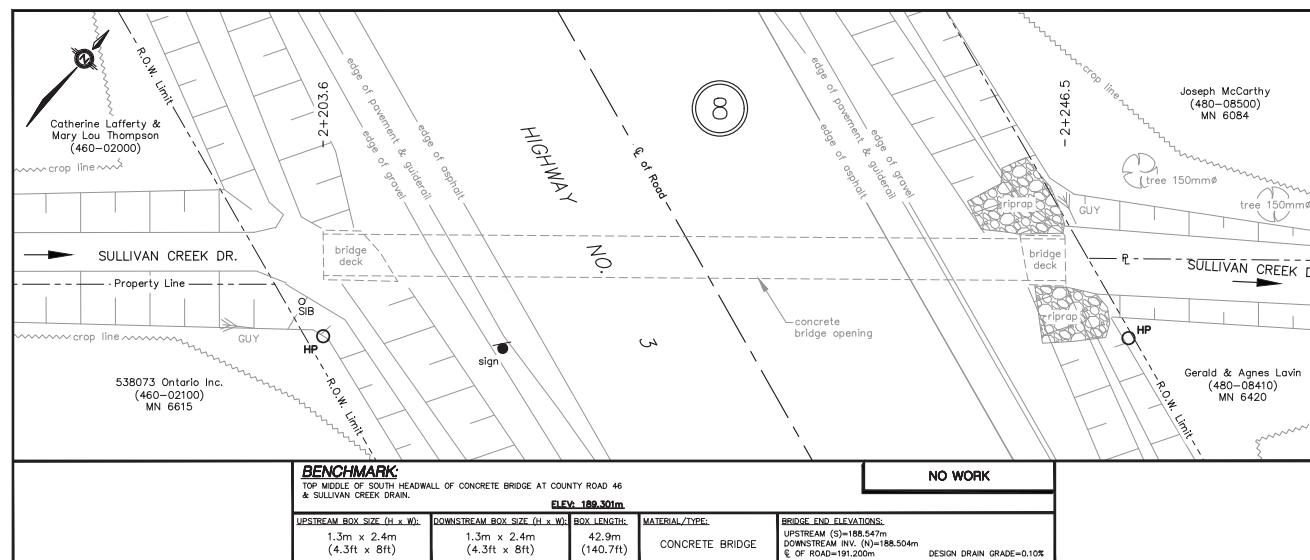

BENCHMARK		NO WORK		BENCHMARK		FOR FUTURE MAINTENANCE	
TOP MIDDLE OF SOUTH HEADWALL OF CONCRETE BRIDGE AT COUNTY ROAD 46 & SULLIVAN CREEK DRAIN.		TOP MIDDLE OF SOUTH HEADWALL OF CONCRETE BRIDGE AT COUNTY ROAD 46 & SULLIVAN CREEK DRAIN.		TOP MIDDLE OF SOUTH HEADWALL OF CONCRETE BRIDGE AT COUNTY ROAD 46 & SULLIVAN CREEK DRAIN.		TOP MIDDLE OF SOUTH HEADWALL OF CONCRETE BRIDGE AT COUNTY ROAD 46 & SULLIVAN CREEK DRAIN.	
ELEV. 189.301m		ELEV. 189.301m		ELEV. 189.301m		ELEV. 189.301m	
UPSTREAM BOX SIZE (H x W)	DOWNSTREAM BOX SIZE (H x W)	BOX LENGTH	MATERIAL/TYPE	BRIDGE END ELEVATIONS	UPSTREAM SB (S)	DOWNSTREAM INV. (N)	% OF DRIVEWAY
1.3m x 2.4m (4.3ft x 8ft)	1.3m x 2.4m (4.3ft x 8ft)	42.9m (140.7ft)	CONCRETE BRIDGE	UPSTREAM INV. (E)=188.547m DOWNSTREAM INV. (N)=188.504m % OF ROAD=191.200m DESIGN DRAIN GRADE=+0.10%	UPSTREAM SB (S)=187.748m DOWNSTREAM INV. (N)=187.640m % OF FARM BRIDGE=189.580m DESIGN DRAIN GRADE=+0.22%	188.547m	187.640m

BRIDGE #8 PLAN

SCALE=1:200

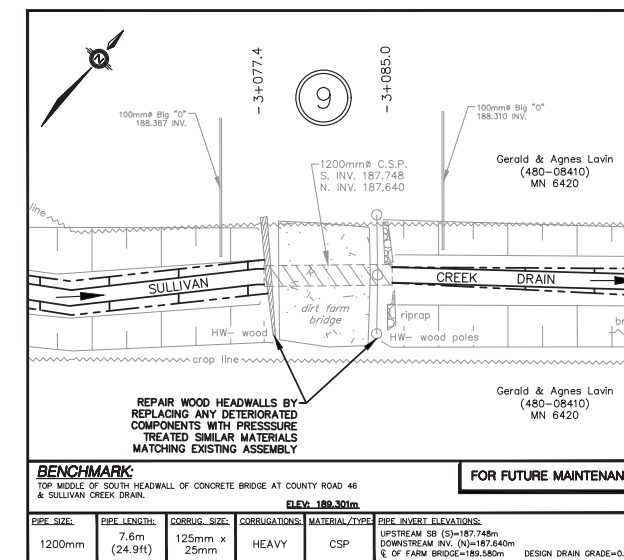

BENCHMARK		FOR FUTURE MAINTENANCE		BENCHMARK		FOR FUTURE MAINTENANCE					
TOP MIDDLE OF SOUTH HEADWALL OF CONCRETE BRIDGE AT COUNTY ROAD 46 & SULLIVAN CREEK DRAIN.		TOP MIDDLE OF SOUTH HEADWALL OF CONCRETE BRIDGE AT COUNTY ROAD 46 & SULLIVAN CREEK DRAIN.		TOP MIDDLE OF SOUTH HEADWALL OF CONCRETE BRIDGE AT COUNTY ROAD 46 & SULLIVAN CREEK DRAIN.		TOP MIDDLE OF SOUTH HEADWALL OF CONCRETE BRIDGE AT COUNTY ROAD 46 & SULLIVAN CREEK DRAIN.					
ELEV. 189.301m		ELEV. 189.301m		ELEV. 189.301m		ELEV. 189.301m					
PIPE SIZE	PIPE LENGTH	CORRUG. SIZE	CORRUGATIONS	MATERIAL/TYPE	PIPE INVERT ELEVATIONS	PIPE SIZE	PIPE LENGTH	CORRUG. SIZE	CORRUGATIONS	MATERIAL/TYPE	PIPE INVERT ELEVATIONS
1200mm	7.6m (24.9ft)	125mm x 25mm	HEAVY	CSP	UPSTREAM SB (S)=187.748m DOWNSTREAM INV. (N)=187.640m % OF FARM BRIDGE=189.580m DESIGN DRAIN GRADE=+0.22%	1200mm	7.6m (24.9ft)	125mm x 25mm	HEAVY	CSP	UPSTREAM SB (S)=187.748m DOWNSTREAM INV. (N)=187.640m % OF FARM BRIDGE=189.580m DESIGN DRAIN GRADE=+0.22%

BRIDGE #9 PLAN

SCALE=1:200

THESE PLANS HAVE BEEN REDUCED AND THE SCALE THEREFORE VARIES. FULL SCALE PLANS MAY BE VIEWED AT THE MUNICIPAL OFFICE.

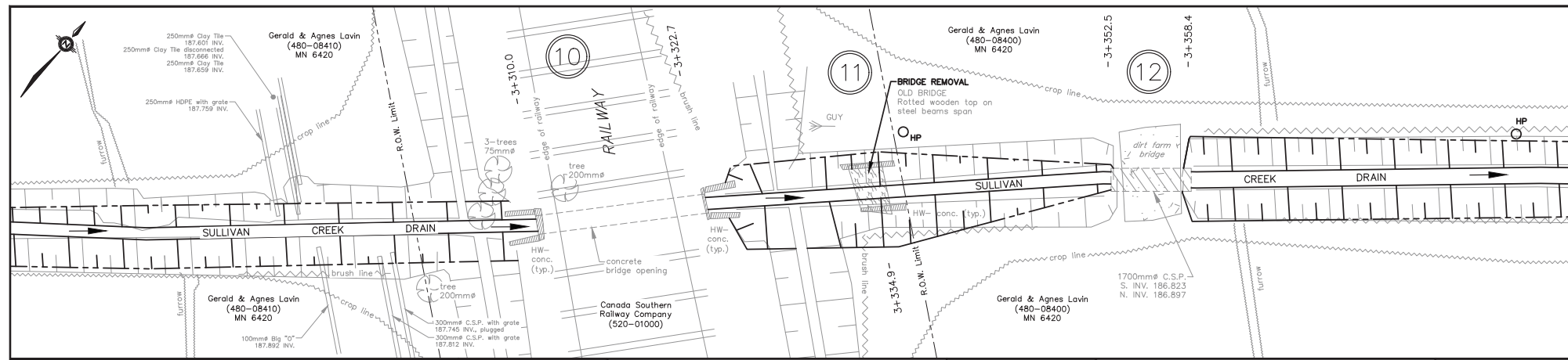

BENCHMARK				FOR FUTURE MAINTENANCE				BENCHMARK				BRIDGE ABANDONMENT				BENCHMARK				FOR FUTURE MAINTENANCE			
TOP MIDDLE OF SOUTH HEADWALL OF CONCRETE BRIDGE AT COUNTY ROAD 46 & SULLIVAN CREEK DRAIN.				TOP MIDDLE OF SOUTH HEADWALL OF CONCRETE BRIDGE AT COUNTY ROAD 46 & SULLIVAN CREEK DRAIN.				TOP MIDDLE OF SOUTH HEADWALL OF CONCRETE BRIDGE AT COUNTY ROAD 46 & SULLIVAN CREEK DRAIN.				TOP MIDDLE OF SOUTH HEADWALL OF CONCRETE BRIDGE AT COUNTY ROAD 46 & SULLIVAN CREEK DRAIN.				TOP MIDDLE OF SOUTH HEADWALL OF CONCRETE BRIDGE AT COUNTY ROAD 46 & SULLIVAN CREEK DRAIN.							
ELEV. 189.301m				ELEV. 189.301m				ELEV. 189.301m				ELEV. 189.301m				ELEV. 189.301m							
UPSTREAM BOX SIZE (H x W):	DOWNSTREAM BOX SIZE (H x W):	BOX LENGTH:	MATERIAL TYPE:	BRIDGE END ELEVATIONS:	BRIDGE SPAN:	BRIDGE LENGTH:	MATERIAL TYPE:	BRIDGE END SB ELEVATIONS:	PIPE SIZE:	PIPE LENGTH:	CORRUG. SIZE:	CORRUGATIONS:	MATERIAL TYPE:	PIPE INVERT ELEVATIONS:	UPS. DESIGN DRAIN GRADE=0.22%	DOWS. DESIGN DRAIN GRADE=0.13%	UPS. DESIGN DRAIN GRADE=0.22%	DOWS. DESIGN DRAIN GRADE=0.13%					
1.20m x 1.54m (3.9ft x 5.1ft)	1.2m x 1.54m (3.9ft x 5.1ft)	12.7m (41.6ft)	CONCRETE BRIDGE	UPSTREAM INV. (S)=187.092m DOWNSTREAM INV. (N)=187.064m % OF RAILWAY=189.90m	3.7m (12.1ft)	2.3m (7.5ft)	STEEL BEAMS SPAN & ROTTED WOOD TOP	UPSTREAM INV. (S)=187.110m DOWNSTREAM INV. (N)=187.050m % OF OLD BRIDGE=189.43m	1700mm	5.9m (19.4ft)	125mm x 25mm	HEAVY	CSP	UPSTREAM INV. (S)=186.949m DOWNSTREAM INV. (N)=186.930m % OF FARM BRIDGE=188.947m									

BRIDGE #10 PLAN

SCALE=1:200

BRIDGE #11 PLAN

SCALE=1:200

BRIDGE #12 PLAN

SCALE=1:200

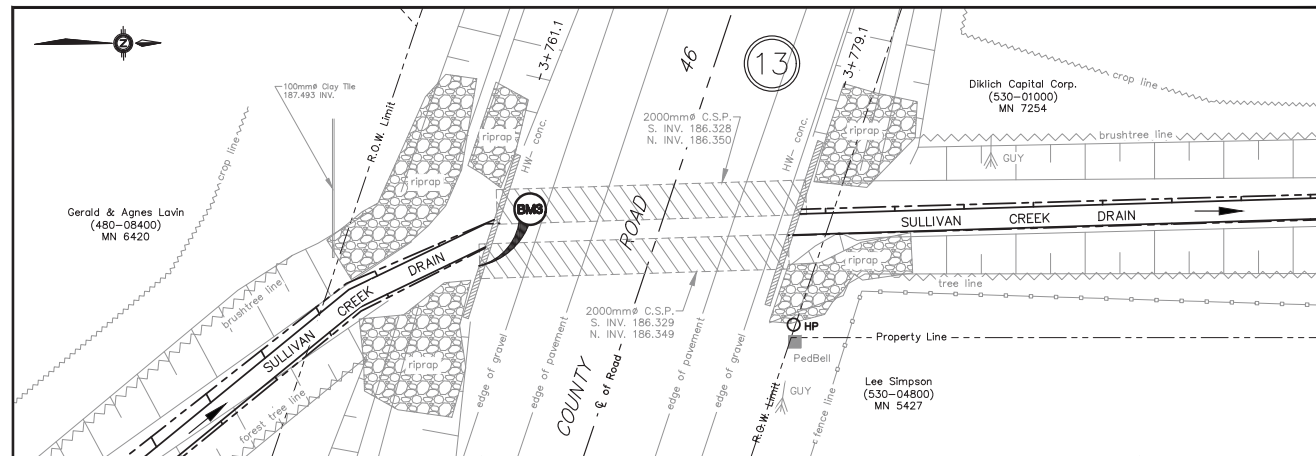

BENCHMARK				FOR FUTURE MAINTENANCE				BENCHMARK				FOR FUTURE MAINTENANCE					
TOP MIDDLE OF SOUTH HEADWALL OF CONCRETE BRIDGE AT COUNTY ROAD 46 & SULLIVAN CREEK DRAIN.				TOP MIDDLE OF SOUTH HEADWALL OF CONCRETE BRIDGE AT COUNTY ROAD 46 & SULLIVAN CREEK DRAIN.				TOP MIDDLE OF SOUTH HEADWALL OF CONCRETE BRIDGE AT COUNTY ROAD 46 & SULLIVAN CREEK DRAIN.				TOP MIDDLE OF SOUTH HEADWALL OF CONCRETE BRIDGE AT COUNTY ROAD 46 & SULLIVAN CREEK DRAIN.					
ELEV. 189.301m				ELEV. 189.301m				ELEV. 189.301m				ELEV. 189.301m					
PIPE SIZE:	PIPE LENGTH:	CORRUG. SIZE:	CORRUGATIONS:	MATERIAL TYPE:	PIPE INVERT ELEVATIONS:	PIPE SIZE:	PIPE LENGTH:	CORRUG. SIZE:	CORRUGATIONS:	MATERIAL TYPE:	PIPE INVERT ELEVATIONS:	PIPE SIZE:	PIPE LENGTH:	CORRUG. SIZE:	CORRUGATIONS:	MATERIAL TYPE:	PIPE INVERT ELEVATIONS:
2000mm	18.0m (59.1ft)	125mm x 25mm	HEAVY	CSP	UPSTREAM INV. (S)=186.382m DOWNSTREAM INV. (N)=186.359m % OF ROAD=189.300m	2000mm	18.0m (59.1ft)	125mm x 25mm	HEAVY	CSP	UPSTREAM INV. (S)=186.382m DOWNSTREAM INV. (N)=186.359m % OF ROAD=189.300m						

BRIDGE #13 PLAN

SCALE=1:200

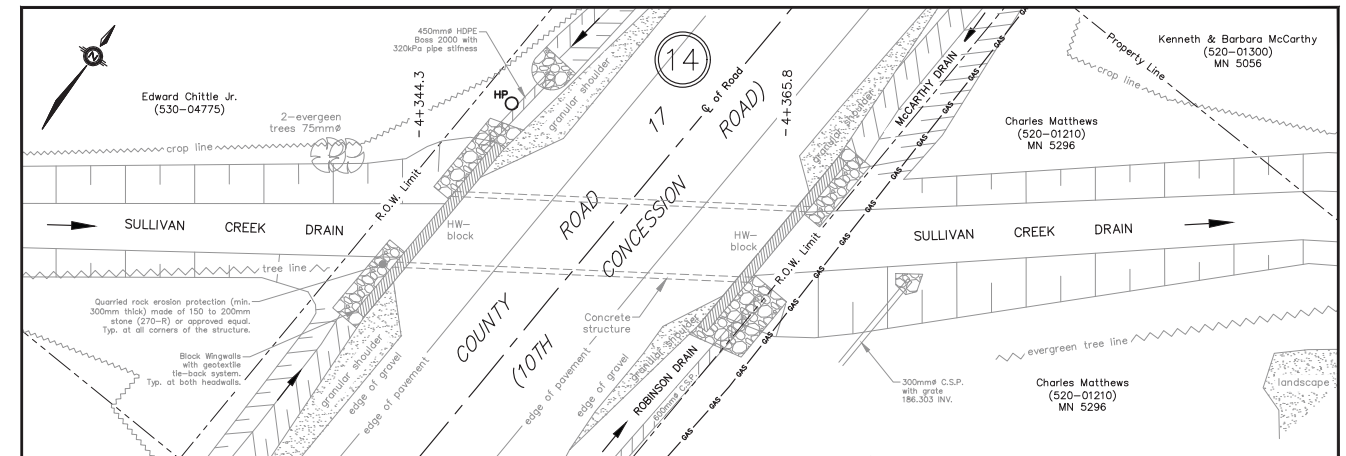

BENCHMARK				NO WORK			
TOP MIDDLE OF SOUTH HEADWALL OF CONCRETE BRIDGE AT COUNTY ROAD 46 & SULLIVAN CREEK DRAIN.				TOP MIDDLE OF SOUTH HEADWALL OF CONCRETE BRIDGE AT COUNTY ROAD 46 & SULLIVAN CREEK DRAIN.			
ELEV. 189.301m				ELEV. 189.301m			
UPSTREAM BOX SIZE (H x W):	DOWNSTREAM BOX SIZE (H x W):	BOX LENGTH:	MATERIAL TYPE:	BRIDGE END ELEVATIONS:	UPSTREAM INV. (S)=185.655m	DOWNSTREAM INV. (N)=185.628m	% OF ROAD=188.283m
1.45m x 3.65m (4.8ft x 12.0ft)	1.45m x 3.65m (4.8ft x 12.0ft)	20.4m (67.0ft)	CONCRETE BRIDGE	UPSTREAM INV. (S)=185.655m DOWNSTREAM INV. (N)=185.628m % OF ROAD=188.283m			

BRIDGE #14 PLAN

SCALE=1:200

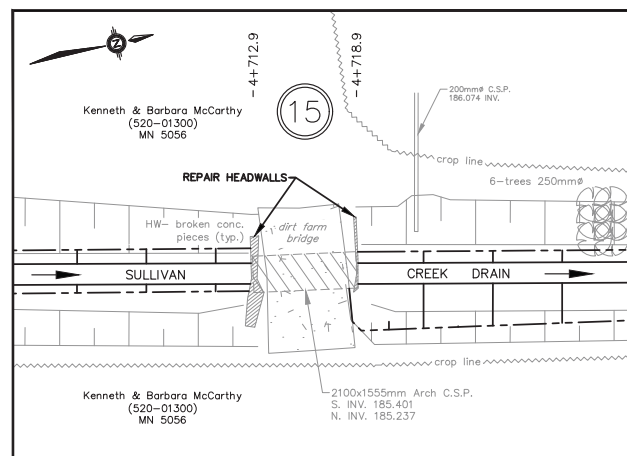

BENCHMARK				FOR FUTURE MAINTENANCE							
TOP MIDDLE OF SOUTH HEADWALL OF CONCRETE BRIDGE AT COUNTY ROAD 46 & SULLIVAN CREEK DRAIN.				TOP MIDDLE OF SOUTH HEADWALL OF CONCRETE BRIDGE AT COUNTY ROAD 46 & SULLIVAN CREEK DRAIN.							
ELEV. 189.301m				ELEV. 189.301m							
PIPE SIZE:	PIPE LENGTH:	CORRUG. SIZE:	CORRUGATIONS:	MATERIAL TYPE:	PIPE INVERT ELEVATIONS:	PIPE SIZE:	PIPE LENGTH:	CORRUG. SIZE:	CORRUGATIONS:	MATERIAL TYPE:	PIPE INVERT ELEVATIONS:
2100mm x 1555mm	6.0m (19.7ft)	125mm x 25mm	HEAVY	Arch CSP	UPSTREAM INV. (S)=185.404m DOWNSTREAM INV. (N)=185.237m % OF FARM BRIDGE=187.124m						

BRIDGE #15 PLAN

SCALE=1:200

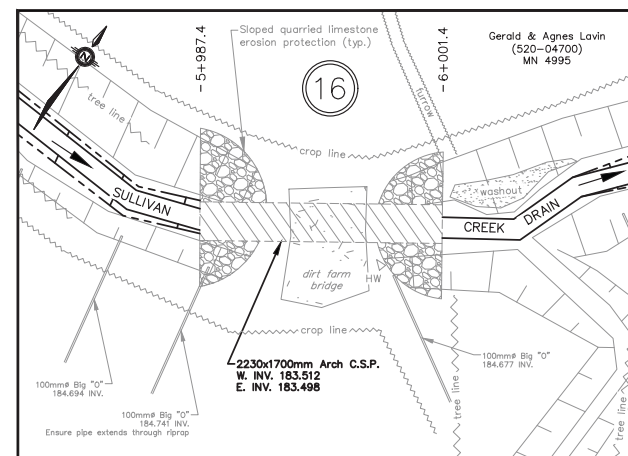

BENCHMARK				FOR FUTURE MAINTENANCE							
TOP MIDDLE OF NORTH DECK OF CONCRETE BRIDGE AT HIGHWAY 401 & SULLIVAN CREEK DRAIN.				TOP MIDDLE OF NORTH DECK OF CONCRETE BRIDGE AT HIGHWAY 401 & SULLIVAN CREEK DRAIN.							
ELEV. 186.113m				ELEV. 186.113m							
PIPE SIZE:	PIPE LENGTH:	CORRUG. SIZE:	CORRUGATIONS:	MATERIAL TYPE:	PIPE INVERT ELEVATIONS:	PIPE SIZE:	PIPE LENGTH:	CORRUG. SIZE:	CORRUGATIONS:	MATERIAL TYPE:	PIPE INVERT ELEVATIONS:
2230mm x 1700mm	14.0m (45.9ft)	125mm x 25mm	HEAVY	Aluminized Arch CSP	UPSTREAM INV. (S)=183.512m DOWNSTREAM INV. (N)=183.498m % OF FARM BRIDGE=185.708m						

BRIDGE #16 PLAN

SCALE=1:200

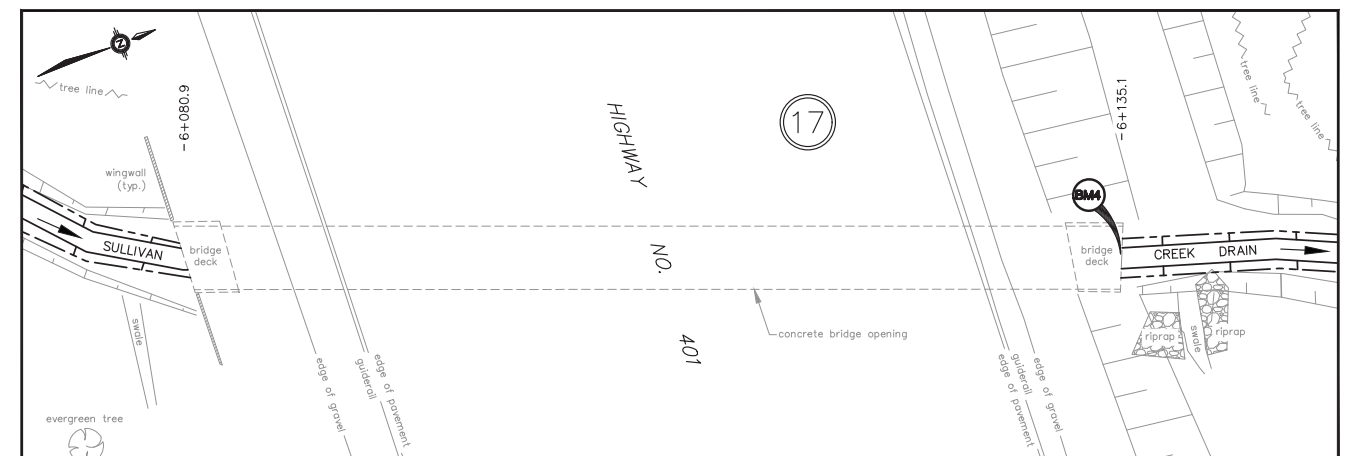

BENCHMARK				FOR FUTURE MAINTENANCE			
TOP MIDDLE OF NORTH DECK OF CONCRETE BRIDGE AT HIGHWAY 401 & SULLIVAN CREEK DRAIN.				TOP MIDDLE OF NORTH DECK OF CONCRETE BRIDGE AT HIGHWAY 401 & SULLIVAN CREEK DRAIN.			
ELEV. 186.113m				ELEV. 186.113m			
UPSTREAM BOX SIZE (H x W):	DOWNSTREAM BOX SIZE (H x W):	BOX LENGTH:	MATERIAL TYPE:	BRIDGE END ELEVATIONS:	UPSTREAM INV. (S)=183.404m	DOWNSTREAM INV. (N)=183.339m	% OF ROAD=186.860m
2.0m x 3.6m (6.6ft x 11.8ft)	2.0m x 3.6m (6.6ft x 11.8ft)	54.2m (177.8ft)	CONCRETE BRIDGE	UPSTREAM INV. (S)=183.404m DOWNSTREAM INV. (N)=183.339m % OF ROAD=186.860m			

BRIDGE #17 PLAN

SCALE=1:200

THESE PLANS HAVE BEEN REDUCED AND THE SCALE THEREFORE VARIES. FULL SCALE PLANS MAY BE VIEWED AT THE MUNICIPAL OFFICE.

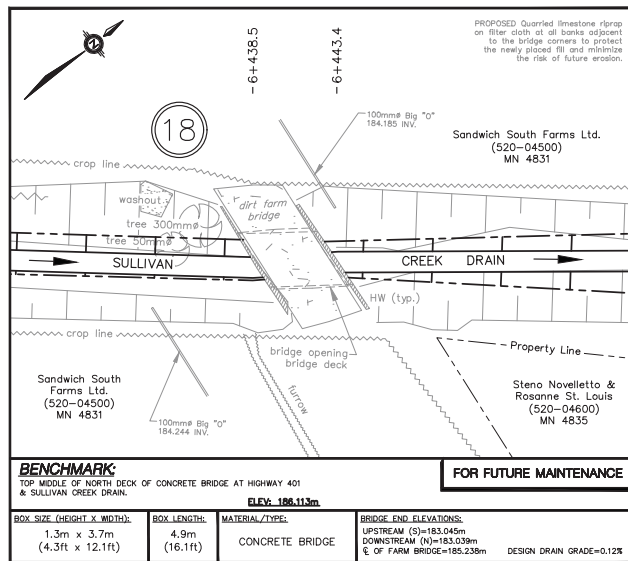

BRIDGE #18 PLAN

SCALE=1:200

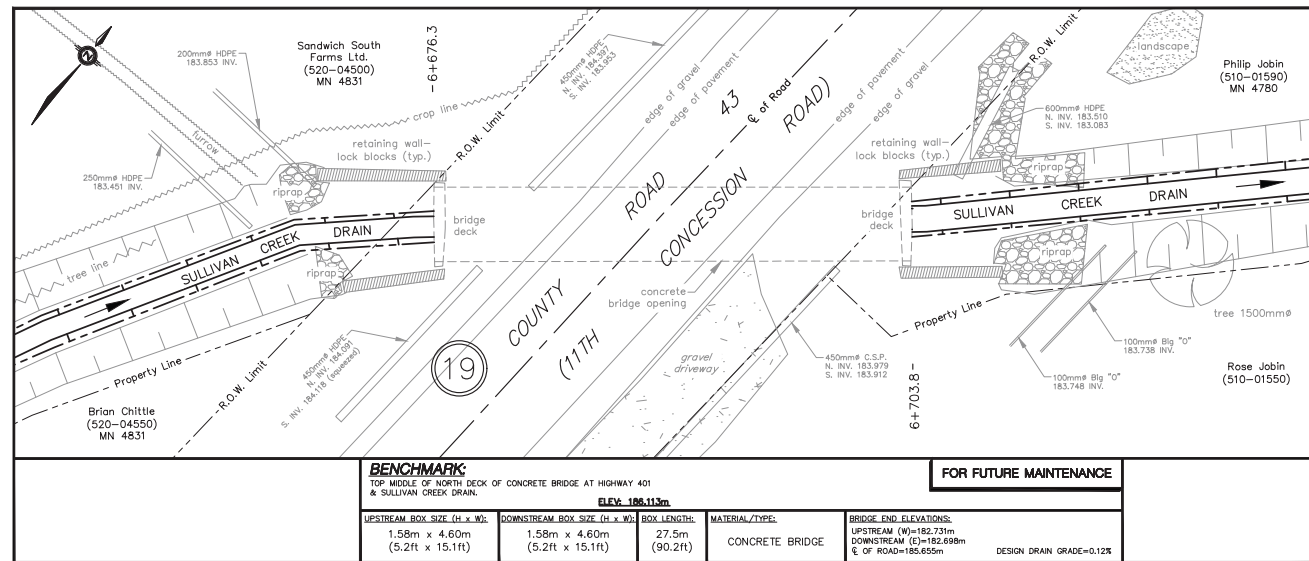

BRIDGE #19 PLAN

SCALE=1:200

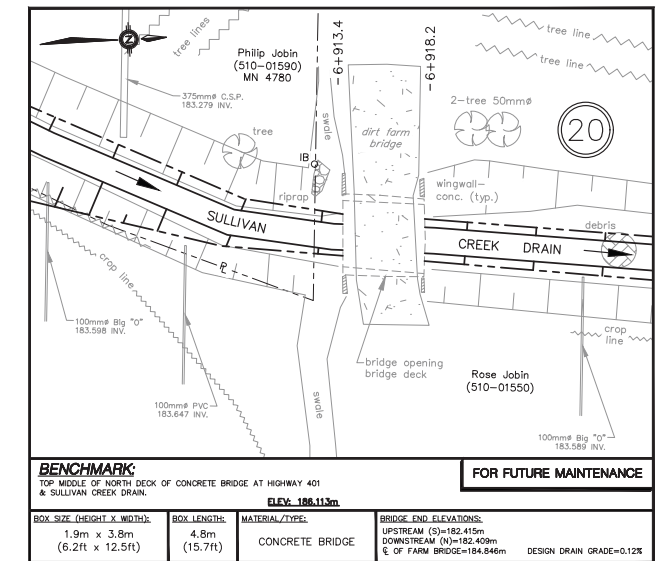

BRIDGE #20 PLAN

SCALE=1:200

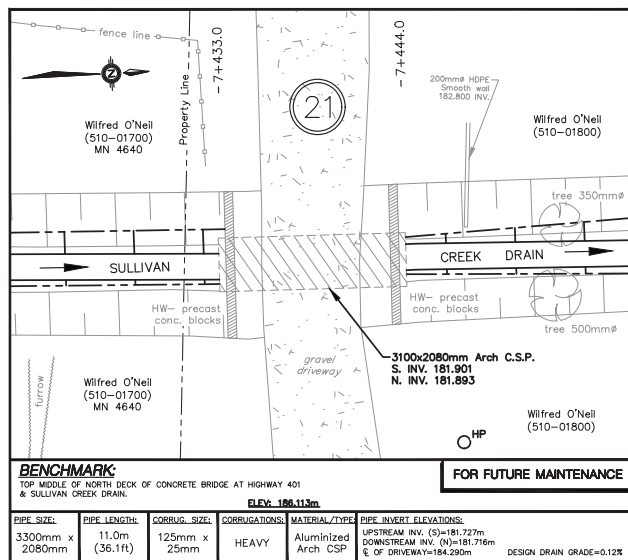

BRIDGE #21 PLAN

SCALE=1:200

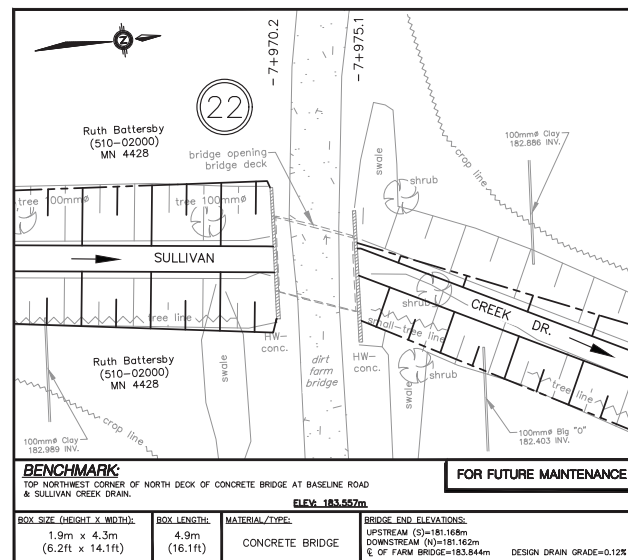

BRIDGE #22 PLAN

SCALE=1:200

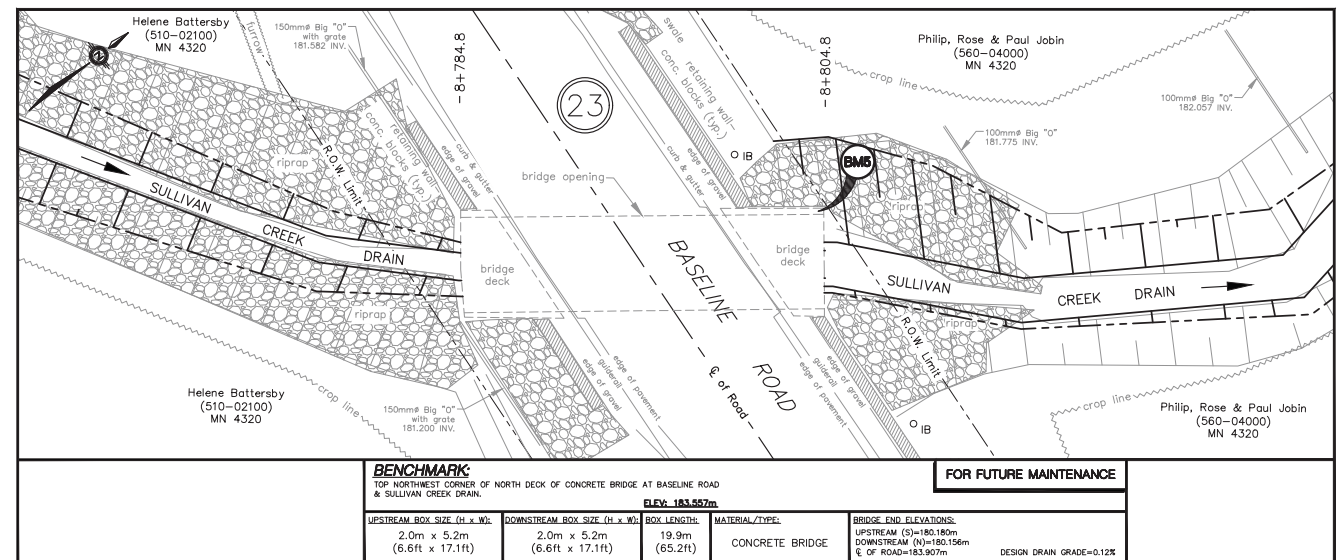

BRIDGE #23 PLAN

SCALE=1:200

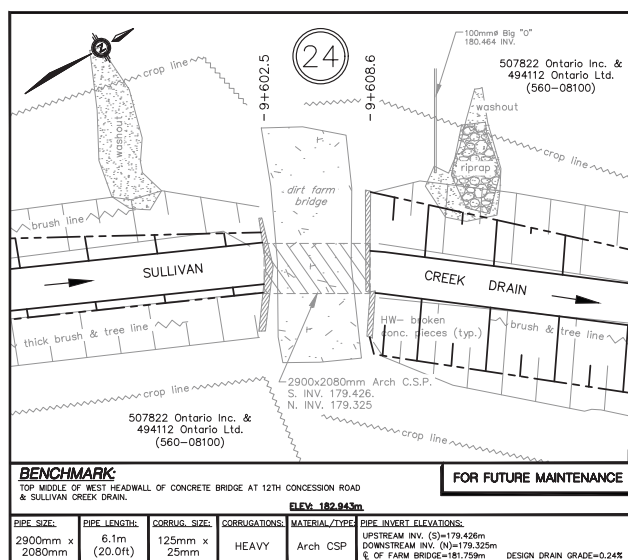

BRIDGE #24 PLAN

SCALE=1:200

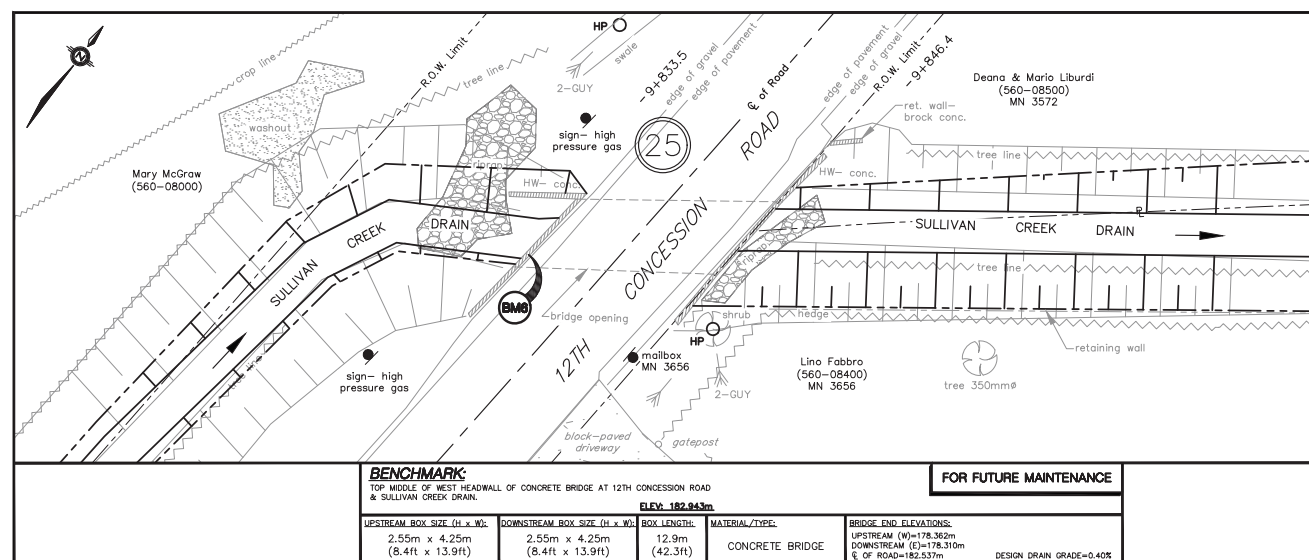

BRIDGE #25 PLAN

SCALE=1:200

THESE PLANS HAVE BEEN REDUCED AND THE SCALE THEREFORE VARIES. FULL SCALE PLANS MAY BE VIEWED AT THE MUNICIPAL OFFICE.